



# Mineral Mine Operator's Manual



Commonwealth of Virginia  
Department of Mines, Minerals and Energy  
Division of Mineral Mining  
900 Natural Resources Drive, Suite 400  
Charlottesville, Va 22903  
(434) 951-6310

This page intentionally left blank

## TABLE OF CONTENTS

1	INTRODUCTION.....	1-1
	1.1 Acknowledgment .....	1-1
	1.2 How To Use This Book .....	1-2
2	POLICY AND PROCEDURES .....	2-1
	2.1 New Permit Application Process .....	2-1
	Permit Package .....	2-1
	Permit/License Application – DMM-101 .....	2-1
	Permit Notifications.....	2-1
	Operations, Drainage and Reclamation Plans .....	2-1
	Mapping .....	2-2
	Initial Site Investigation .....	2-2
	2.2 Permit/License Renewal .....	2-2
	2.3 Field Approval.....	2-3
	Permit Applications .....	2-3
	Amendments.....	2-4
	Field Approval Procedure .....	2-4
	2.4 General Permit for Sand and Gravel Operations Less Than Ten Acres in Size.....	2-6
	General Terms and Conditions .....	2-6
	Off-Site Materials / Hazardous Waste .....	2-8
	Signs.....	2-8
	Marking Of Permit Boundaries .....	2-8
	Roads .....	2-8
	Drainageways .....	2-9
	Screening.....	2-9
	Mining Method, Topsoil Storage and Drainage Control .....	2-9
	Mining Below the Water Table.....	2-10
	Metal and Debris.....	2-10
	Completed Slopes .....	2-10
	Acid Material .....	2-10
	Revegetation.....	2-10
	Closure Of Roads Or Openings.....	2-10
	Permit Amendments to a General Permit will be required for: .....	2-11
	2.5 Violation Appeal.....	2-11
	Procedure For Appeal Of Safety or Reclamation Violations .....	2-11
	Informal Conference APA Section 9-6.14:11.....	2-11
	2.6 Bond Release .....	2-13
	2.7 Temporary Cessation.....	2-19
	Request for Temporary Cessation .....	2-19
3	FORMS .....	3-1
	3.1 Notice of Operator Intent—Form DMM-156 .....	3-1

3.2	Request for Amendment—Form DMM-113 .....	3-3
3.3	Contractor Identification —Form DMM-166 .....	3-5
3.4	Annual Reporting—Forms DMM-146 & DMM-146C .....	3-7
	Annual Tonnage Report, Form DMM-146 .....	3-7
	Mineral Mining Annual Report for Contractors, Form DMM-146C.....	3-7
3.5	Yearly Progress Report—Form DMM 105 .....	3-12
3.6	License Renewal/Transfer Application—Form DMM-157 .....	3-16
3.7	Permit/License Application —Form DMM-101 .....	3-22
3.8	Mineral Mining Map Legend—Form DMM-109 .....	3-31
4	OVERBURDEN AND SPOIL DISPOSAL AREAS .....	4-1
4.1	Definition .....	4-1
4.2	Purpose .....	4-1
4.3	Conditions Where Practice Applies.....	4-1
4.4	Construction Specifications.....	4-1
4.5	Plan Preparation .....	4-4
4.6	Other Types of Fills.....	4-4
4.7	Determining the Stop Point on Dump Construction Fills .....	4-9
4.8	Typical Causes of Fill Failures .....	4-9
4.9	Helpful Slope Calculations and Conversions .....	4-9
5	REVEGETATION .....	5-1
5.1	Planning For Revegetation .....	5-1
5.2	Public Considerations .....	5-1
5.3	Operational Considerations .....	5-1
5.4	Developing a Favorable Planting Medium .....	5-1
5.5	Selecting Material for Planting Medium.....	5-2
5.6	Tests Useful in Selecting Overburden Materials .....	5-3
5.7	Composition of Planting Medium .....	5-3
5.8	Surface and Seedbed Characteristics .....	5-4
5.9	Soil Testing, Liming and Fertilization .....	5-4
	Soil Testing.....	5-4
	Collecting Soil-Spoil Samples .....	5-6
	Lime .....	5-6
5.10	Fertilization .....	5-7
5.11	Grass and Legume Mixtures and Their Establishment .....	5-7
	Seeding Dates .....	5-7
	Seeding Methods.....	5-8
	Native and Reclamation Grasses.....	5-8
	Recommended Seeding Specifications.....	5-8
	Low Growing Mix Suitable for Planting Seedlings.....	5-19
5.12	Invasive Species.....	5-19

5.13	Tree Planting .....	5-19
	Planting of Seedlings .....	5-20
	Seedling Care .....	5-20
	Time of Planting .....	5-20
	Seedling Sources .....	5-20
	Plantation Management .....	5-20
	Screening, Noise, and Dust Abatement .....	5-22
5.14	Plantings for Wildlife Habitat .....	5-22
	Annuals .....	5-22
	Perennial Grasses and Legumes .....	5-22
	Woody Perennials .....	5-22
	Planting Design .....	5-23
5.15	Vegetation of Critical or Problem Areas .....	5-23
5.16	Mulches for Critical or Problem Areas .....	5-23
6	WILDLIFE PLAN .....	6-1
6.1	Habitat Requirements .....	6-1
	Food .....	6-1
	Cover .....	6-1
	Water .....	6-1
	Interspersion .....	6-2
6.2	Choice of Vegetation .....	6-2
6.3	Choice of Wildlife .....	6-3
7	DRAINAGE .....	7-1
7.1	Introduction .....	7-1
7.2	Subsurface Drain .....	7-1
	Definition .....	7-1
	Purpose .....	7-1
	Conditions Where Practice Applies .....	7-2
	Planning Considerations .....	7-2
	Design Criteria .....	7-2
	Relief Drains .....	7-2
	Interceptor Drains .....	7-2
7.3	Buffer Zone .....	7-4
	Definition .....	7-4
	Purpose .....	7-4
	Conditions Where Practice Applies .....	7-6
	Design Criteria .....	7-6
	Planning Considerations .....	7-6
	Buffer Zone Establishment and Maintenance .....	7-7
7.4	Pipe Slope Drain .....	7-7
	Definition .....	7-7
	Purpose .....	7-7

	Conditions Where Practice Applies .....	7-7
	Planning Considerations.....	7-7
	Design Criteria .....	7-7
	Drainage Area.....	7-7
	Entrance Sections.....	7-9
	Dike Design .....	7-9
	Outlet Protection .....	7-12
	Maintenance .....	7-12
7.5	Geotextiles.....	7-12
	Products and Uses.....	7-12
	Installation of Soil Stabilization Matting .....	7-12
	Definition .....	7-13
7.6	Sediment Basins.....	7-18
	Purpose .....	7-18
	Conditions Where Practice Applies.....	7-18
	Design Criteria for Sediment Basins—Compliance with Laws and Regulations.....	7-18
	Location .....	7-18
	Storage volume.....	7-18
	Clean out .....	7-19
	Structure in Series or Parallel.....	7-19
	Outlet Facilities .....	7-19
	Pipe Spillways.....	7-22
	Open Channel Spillways.....	7-22
	Freeboard .....	7-22
	Perforated Riser.....	7-29
	Anti-vortex Device and Trash Rack.....	7-29
	Base.....	7-29
	Anti-seep Collars .....	7-29
	Outlet Protection .....	7-34
	Provision for Lowering Runoff Into Basin .....	7-34
	Construction Specifications .....	7-38
	Site Preparation.....	7-38
	Cut-Off Trench.....	7-38
	Embankment.....	7-38
	Pipe Spillways.....	7-39
	Open Channel Spillways.....	7-39
	Vegetative Treatment .....	7-39
	Erosion and Pollution Control .....	7-39
	Safety.....	7-39
	Maintenance .....	7-39
	Abandonment Procedure for Temporary Basins .....	7-40
7.7	Sediment Basin Design Examples.....	7-40
	Excavated Sediment Basin Design Examples .....	7-40
	Open channel spillway design .....	7-40
	Decant Pipe Design .....	7-42
	Pond Design .....	7-51

7.8	Sediment Channel .....	7-54
	Purpose .....	7-54
	Conditions Where Practice Applies .....	7-54
	Design Criteria .....	7-54
	Open Channel Spillways.....	7-57
	Decant Pipe Spillways .....	7-57
	Construction Specifications .....	7-59
	Maintenance .....	7-59
	Abandonment .....	7-59
	Sediment Channel Design Example.....	7-59
7.9	Stone Filter Berms .....	7-61
	Definition .....	7-61
	Purpose .....	7-61
	Conditions Where Practice Applies .....	7-61
	Design Criteria .....	7-61
	Construction Specifications .....	7-62
	Maintenance .....	7-62
	Abandonment .....	7-62
7.10	Temporary Sediment Control .....	7-62
	Purpose .....	7-62
	Conditions Where Practice Applies .....	7-63
	Design Criteria .....	7-63
	Silt Fence .....	7-63
	Construction Specifications .....	7-64
	Maintenance .....	7-67
	Abandonment .....	7-67
	Straw Bale Barrier.....	7-67
	Construction Specifications .....	7-67
	Maintenance .....	7-69
	Abandonment .....	7-69
	Construction Specifications .....	7-69
	Maintenance .....	7-71
	Abandonment .....	7-71
7.11	Heavy Metals .....	7-71
8	GENERAL FENCING SPECIFICATIONS FOR STANDARD WOVEN WIRE FENCE ..	8-1
8.1	Materials .....	8-1
	Fence Fabric.....	8-1
	Posts .....	8-1
	Barbed Wire.....	8-1
	Fitting and Supports .....	8-1
	Concrete.....	8-1
	Danger Signs .....	8-1
8.2	General .....	8-1
	Posts .....	8-2

	Wire Fabric .....	8-2
	Work Site Damages .....	8-2
	Final Inspection.....	8-2
9	ROADWAYS .....	9-1
9.1	Definition .....	9-1
9.2	Purpose .....	9-1
9.3	Condition Where Practice Applies .....	9-1
9.4	Design Criteria .....	9-1
	Road Surface.....	9-1
	Drainage and Sediment Control.....	9-4
	Culverts .....	9-4
	Relation to Streams.....	9-8
	Natural Drainageways .....	9-8
	Stream Crossings .....	9-8
	Buffer Zone .....	9-8
	Slopes .....	9-9
9.5	Maintenance .....	9-9
	Definition .....	9-9
	Purpose .....	9-9
	Conditions Where Practice Applies .....	9-9
	Planning Consideration .....	9-9
	Design Criteria .....	9-9
	Construction Specifications .....	9-10
	Manning's Formula to Determine Flow in Streams.....	9-12
10	GROUND WATER PROTECTION.....	10-1
10.1	Definitions .....	10-1
10.2	Purpose .....	10-1
10.3	Key Steps Towards Developing the Ground Water Protection Plan.....	10-2
10.4	Evaluation of Baseline Hydrologic Conditions.....	10-3
	Inventory of Existing Ground Water Use .....	10-3
	Static Water Table and Maximum Depth of Mining .....	10-3
	Measuring Static Ground Water Levels.....	10-4
	Electric Sounder or Electric Depth Gauge Method.....	10-8
	Chalk and Graduated Steel Tape Method .....	10-8
	Air Line and Pressure Gauge Method .....	10-9
	Hydraulic Gradient .....	10-10
	Cross Section Method .....	10-10
	Three-Point Method.....	10-10
	Estimating Natural Ground Water Discharge.....	10-11
	Measuring Natural Discharge of Springs.....	10-11
	Measuring Natural Discharge as Base Flow of a Stream.....	10-12
	Estimating Discharge as Subsurface Outflow .....	10-12
	Estimating Natural Recharge .....	10-15



Measuring Precipitation .....	10-16
Measuring Recharge as Stream Flow Seepage.....	10-16
Ground Water Velocity .....	10-16
Aquifer Properties .....	10-17
Porosity and Specific Yield .....	10-17
Hydraulic Conductivity .....	10-18
Transmissivity .....	10-18
Ground water storage .....	10-18
Geologic Factors.....	10-19
Land Use .....	10-19
Ground Water Chemistry.....	10-19
10.5 Assessment of Potential Impacts.....	10-20
Effects of Ground Water Withdrawals on Water Supply .....	10-20
Effects of Removing Portions of an Aquifer on Water Supply .....	10-21
Managing Pumped Ground Water .....	10-21
Expected Changes in Ground Water Quality .....	10-22
Potential for Accidental Release of Pollutants .....	10-24
10.6 Ground Water Protection Plan .....	10-24
10.7 Water Supply Inventory List.....	10-26
<b>APPENDIX A: CONTACTS (GENERAL AND EMERGENCY).....</b>	<b>1</b>
General Contacts .....	3
Department of Environmental Quality.....	4
Virginia Department of Emergency Management.....	5
<b>APPENDIX B: ENGLISH TO METRIC .....</b>	<b>1</b>

This page intentionally left blank.

## FOREWORD

This Mineral Mine Operator's Manual replaces the Minerals Other than Coal Revegetation Guidelines and the Surface Mining Drainage Handbook portions of the 1987 *Minerals Other than Coal Surface Mining Regulations*, 4 VAC 25-30. In addition, the 1987 *Minerals Other than Coal Surface Mining Regulations* were replaced in 2003 with the *Reclamation Regulations for Mineral Mining*, 4 VAC 25-31.

The purpose of the manual is to serve as a technical guide to meet the requirements of the Minerals Other Than Coal Surface Mining Act and the *Reclamation Regulations for Mineral Mining*. The Minerals Other Than Coal Surface Mining Act and the *Reclamation Regulations for Mineral Mining* establish the minimum acceptable engineering and environmental performance standards for activities on mineral mine sites. This manual contains guidelines and support materials to assist users in implementing the technical standards in accordance with the provisions of the Act and the regulations.

Questions or comments about this Manual or the Mineral Mining program in general may be directed to the Division of Mineral Mining.

This page intentionally left blank.

# 1 INTRODUCTION

Mineral mine operators and the public often have questions and need assistance with the application of law and regulatory standards to specific activities on mines. Sometimes there is a need for guidance on the procedures for completing forms and records that comply with the Minerals Other Than Coal Surface Mining Act and the *Reclamation Regulations for Mineral Mining*. The Virginia Department of Mines, Minerals and Energy's (DMME) Division of Mineral Mining (DMM) created this Mineral Mine Operator's Manual to help mine operators meet the performance standards of law and regulation, communicate agency procedures, and assist in completing forms and records.



The Mineral Mine Operator's Manual is designed as a guidance document to assist operators in complying with the requirements of Virginia mineral mining law and regulation. The information and forms provided in this manual are only for guidance and assistance. The operator may choose to use the guidance and instructions in the manual, modify the techniques or establish company-specific procedures. As long as the performance standards required by law and regulation are maintained, the design and construction techniques that are used are at the option of the operator.

The Mineral Mine Operator's Manual is intended to help communicate the agency's procedures and to complete the required forms and records. We have made an effort to include information for most requirements; however, it is the operator's responsibility to review the law and regulation and maintain compliance with all requirements whether addressed in this manual or not. If additional guidance or clarification seems necessary, please contact the DMM office or your mine inspector to discuss the requirement.

From time to time and following changes in applicable law or regulation, DMM may update the forms and information in the Mineral Mine Operator's Manual. Notice of such updates will be made available to operators by mail, through their area mine inspector or the DMM office in Charlottesville. Operators are expected to fully comply with the applicable law and regulation at all times. Updates to the manual will be made as timely as possible; however, it remains the operator's obligation to comply with all law and regulation.

## 1.1 ACKNOWLEDGMENT

The Mineral Mine Operator's Manual was prepared by DMME's Division of Mineral Mining as a non-regulatory guidance document to assist operators in complying with Title 45.1 of the Code of Virginia. The concept for the document was based on suggestions from mine operators, public input during the regulatory development process, and DMM staff. Mine operators, members of the Virginia Transportation Construction Alliance, and DMME staff helped in developing the document through consultation, material creation or review. The valuable assistance of all those involved in the project is greatly appreciated.

## 1.2 HOW TO USE THIS BOOK

The 2003 Virginia mineral mining reclamation regulations removed many of the required drainage and reclamation practices included in the Revegetation Guidelines and Drainage Handbook and placed the essential requirements in the rule. The 2003 regulation is designed to be more performance based and less prescriptive. This Mineral Mine Operator's Manual is designed to be an aid to assist operators in complying with the requirements of Virginia mineral mining laws and regulations.

Copies of this manual may be obtained from the Commonwealth of Virginia, Department of Mines, Minerals and Energy, Division of Mineral Mining, 900 Natural Resources Drive, Ste. 400, Charlottesville, VA 22903 (434) 951-6310.

The Division of Mineral Mining, in an effort to make information more readily available to our customers, will evaluate the feasibility of distributing the Mineral Mine Operator's Manual by electronic means.

The *Reclamation Regulations for Mineral Mining* published in 2003 are intended to ensure environmentally sensitive mining methods are used during active mining operations and to reclaim mined land in order to preserve public health, safety and physical property. The regulation defines and incorporates proper engineering practices to be used in the reclamation of mined land. The revised regulation has substantial changes and completely replaces the 1987 *Minerals Other Than Coal Surface Mining Regulations*. The regulation is re-organized to improve clarity and understanding. It incorporates the most recent mine-industry engineering practices and the most recent practices involving environmental protection and sediment and erosion controls. Additionally, this regulation considers the impact of mineral mining and the proper management and protection of natural resources, including surface and ground water.

## **2 POLICY AND PROCEDURES**

### **2.1 NEW PERMIT APPLICATION PROCESS**

#### **Permit Package**

A mine permit/license issued by the Division of Mineral Mining is required prior to any commercial extraction and sale of mineral. The prospective operator shall either contact the DMM Charlottesville office to obtain a permit application package, or download the permit package from the Division of Mineral Mining internet web site at [www.dmme.virginia.gov/dmm](http://www.dmme.virginia.gov/dmm). The permit application package consists of 1) Permit/License Application – Form DMM 101, 2) Notice of Application to Mine – Form DMM 103, 3) Property Owners List – Form DMM 103a, 4) Map Legend – Form DMM 109, and 5) DMM Application Checklist – Form DMM 148. The completed forms along with maps, engineering plans, and other required information must be reviewed and approved by the Division prior to commencing mining. The following is an outline of the steps necessary to complete a permit application.

#### ***Permit/License Application – DMM-101***

The prospective operator shall complete the DMM Permit/License Application addressing all questions. The application form contains the general information pertaining to the 1) ownership, 2) operations, and 3) the operating and reclamation plans. For more detail on how to complete Form DMM-101 refer to Section 3.7 of this manual.

#### ***Permit Notifications***

The law requires that the prospective operator notify all owners of property within 1000 feet of the proposed permit boundary of their intent to obtain a mineral mine permit/license. The Notice of Application to Mine (Form DMM-103) shall be either sent by certified mail return receipt required or hand delivered to all identified landowners, and proof of delivery provided to the Division. A list of all persons sent this notification shall be kept on Form DMM-103a and the list and return receipts, or other proof of delivery, provided to the Division with the completed permit/license application. Proof of notification to the local chief administrative official, usually the county administrator or city manager, as well as proof of notification to all utilities with facilities (power lines, pipelines, towers, etc) within 500 feet of the permit boundary, must also be submitted with the application.

#### ***Operations, Drainage and Reclamation Plans***

The contents for the required operations, drainage and reclamation plans are outlined in the Permit Application Checklist (Form DMM-148). The operations plan shall address items such as:

- 1) method of mining;
- 2) mineral processing;
- 3) spoil, overburden, and waste disposal and handling;
- 4) topsoil handling; and
- 5) access road construction and maintenance.

Drainage plans shall detail what drainage controls are to be employed and include engineering designs and calculations, where necessary. Construction, maintenance and abandonment of drainage structures shall also be addressed within the drainage plan.

A reclamation plan outlining the measures to be used to reclaim the mined area once mining ceases shall also accompany the permit application. Issues such as: 1) post mining land use, 2) backfilling and re-grading, and 3) revegetation must be included in this narrative.

### **Mapping**

A permit map must be included as part of the permit application. The map must be of a scale no less than 1" equal to 400' and show the entire permit area. Other features that the map must show include:

- 1) boundaries and names of surface property owners within 100 feet of the permit boundary;
- 2) sensitive features such as streams, creeks, and other bodies of water, public roads, churches, cemeteries, public buildings, occupied dwellings, utilities and utility lines, oil and gas wells on or within 1000 feet of the permit boundary;
- 3) the property boundary of tract being mined;
- 4) the direction of surface drainage flow; and
- 5) a north arrow and be color coded in accordance with the instruction provided on the Map Legend (Form DMM-109). Instructions for filling-out Form DMM-109 can be found in Section 3.7 of this manual.

### **Initial Site Investigation**

Once the prospective operator for the proposed mineral mine has prepared all forms, mine plans and maps, they must be reviewed for completeness by the mine inspector assigned to the area. This step must be completed before the permit package will be accepted by the DMM Charlottesville office for final technical review. The mine inspector will reference his review to those items found on the DMM Application Checklist (Form DMM-148). Any necessary changes, additions or corrections will be detailed and listed in the report. All items noted by the mine inspector must be addressed prior to submittal of the permit package to the DMM office.

## **2.2 PERMIT/LICENSE RENEWAL**

All permits/licenses issued by the Division are valid for one year from the date of issuance and must be renewed annually thereafter on their anniversary date, in accordance with the provisions of Section 45.1-185 of the Mineral Mining Reclamation Law. The following procedure shall be followed when renewing a permit/license.

Ninety days prior to the permit anniversary date the Division will send the mine operator a Renewal Special Order Notice (DMM-106) notifying them of their upcoming renewal and will also provide them with the necessary renewal documents to be completed. These documents normally include a Yearly Progress Report (DMM-105), Map Legend (DMM-109), and License Renewal Application (DMM-157). A progress map of the permit will also



be required where changes to the mine have taken place during the past 12 months. These changes may include additional disturbed acreage, revegetation of portions of the disturbed area, request for additional disturbed acreage, or requests for release of bond on reclaimed land. When no changes have taken place, a statement indicating this may be submitted in lieu of the progress map.

Once completed, these documents must be submitted to the operator's area mine inspector for review no later than 60 days prior to the permit anniversary. The mine inspector will schedule a site visit at which time the areas disturbed, re-graded, and vegetated will be checked against those indicated on the progress map. The mine operator is invited to accompany the inspector on this site visit. The mine inspector will review all permit renewal documents and make any recommendations for corrections or additions to these materials on the Permit Renewal Checklist. The renewal material along with the Permit Renewal Checklist will be sent back to the mine operator no later than 30 days prior to the anniversary date.

The mine operator must make all necessary corrections and additions to the renewal materials as noted by the inspector on the Permit Renewal Check List and then submit the renewal package including all forms, fees and the checklist to the DMM office. Permit renewals must be submitted no later than 10 days prior to the anniversary date. Failure to meet this deadline will result in the issuance of a Notice of Non-Compliance and a Closure Order. Failure to submit within 10 days of issuance of the Notice of Non-compliance can result in forfeiture of the bond and revocation of the mining permit/license.

## **2.3 FIELD APPROVAL**

In order to facilitate the issuance of mining permits/licenses and amendments/revisions to existing permits, Mine Inspectors may grant "field approval" in certain cases.

### **Permit Applications**

Permit or re-permit applications that meet all of the following criteria may be field-approved:

1. Where all drainage is contained in the pit or where only sediment traps are used for drainage control and the drainage area is less than five acres are utilized.
2. When the permit acreage is 50 acres or less.
3. Where there are no homes, not owned by the operator, closer than 500 feet to the proposed mine pit area.
4. When the Division receives no requests for a public hearing.
5. Where the proposed mine is not within one mile of a public water supply (well or reservoir) in the same watershed.
6. Where there are no current or previous environmental problems associated with the mine.
7. When no special permits (such as VMRC, Corps of Engineers, or DEQ-Waste permits) are required.

8. When no overburden or tailings disposal facilities will be constructed, except that overburden may be used to create a berm with a slope not exceeding 18 degrees or 33 percent (3:1).
9. Where no underground workings are proposed nor will be encountered during mining.

If a permit or re-permit application cannot be fully field approved (i.e., does not meet all nine criteria listed above), then one or more of the following parts of the application may be field-approved [refer to DMM Application Checklist (form DMM-148)]:

Part 1.1—Application Operations Plan Form DMM-101

Part 1.2—Permit Notifications

Part 1.3—Permit Sign

Part 1.4—Relinquishment

Part 1.6—Discussion of Other Agency Permits with Operator

Part 4.1—Post Mining Land Use

Part 4.2—Backfilling and Regrading

Part 4.3—Revegetation

## Amendments

Permit amendments that meet the following criteria may be field-approved:

1. Temporary cessation.
2. Mine site disposal of on-site generated wastes.
3. Requests to bring off-site generated inert materials onto the mine site for use, recycling, or disposal.
4. Changes to post mining land use.
5. License application/renewal updates, DMM contact person, changes in address, or corporate officer changes not involving change in ownership.
6. Minor sediment control modifications not affecting drainage areas larger than five acres or requiring design of major sediment control structures.
7. Forestry management or other agricultural activities on the mine permit.
8. Bond release or reduction.
9. Amendments to add to permitted or bonded acreage—only those that meet constraints for Permit Field Approval or on permits where the amended acreage does not exceed 20 percent of the total permitted acreage.

## Field Approval Procedure

Table 2-1 summarizes the field approval process. The field approval procedure is as follows:

1. The operator or the operator's engineer shall prepare the permit/license document and address all items in accordance with the DMM Application Checklist (DMM-148) and the Mineral Mining Laws and Regulations.

**Table 2-1: Field Approval Timelines**

	Inspector	Mine Inspector Supervisor	Engineering Manager	Program Support Technician
Permit or Re-permit Application	X 30 days	X 21 days	X 4 days	X 4 days
Parts of Permit Applications	X 30 days		X 21 days	X 8 days
Permit Transfer	X 15 days		X 10 days	X 5 days
Temporary Cessation	X 30 days	X 15 days		X 2 days
Mine site disposal of on-site generated wastes	X 30 days	X 15 days		X 2 days
Mine site use of recycling of off-site generated <u>inert</u> wastes	X 30 days	X 15 days		X 2 days
Change of Post Mining Land Use	X 30 days	X 15 days		X 2 days
License Application/Renewal updates, DMM contact person, change of address, corporate officer changes not involving change in ownership	X 30 days			X 8 days
Sediment control modification not affecting drainage areas larger than five acres	X 30 days	X 15 days		X 2 days
Forestry management or other agricultural activities at the mine	X 30 days	X 15 days		X 2 days
Bond Release or Reduction—Mine Inspector to check the approve or deny box	X 60 days		X 15 days	X 2 days
Amendments to add permitted or bonded acreage (within guidelines)	X 30 days	X 15 days		X 6 days
This table represents self-imposed performance standards to improve services to customers. Those staff members reviewing plans/documents ensure state law standards are being met without which processing could not be accomplished.				

- The Mine Inspector shall review the permit/license package to determine if it is complete and addresses all applicable standards.

If the Mine Inspector determines that the documents are incomplete, the inspector will return the document to the applicant with a written report identifying the deficiencies.

If the Mine Inspector determines that the revision is complete and satisfies the applicable standards, the inspector will determine if the application meets the criteria for field approval. If it does not, the mine inspector will return the package to the applicant for submittal to the Division of Mineral Mining (DMM) office for review. If the document is acceptable for field review and approval, the inspector will conduct a field review and acknowledge in writing his approval of the permit/license application.

The field-approved documents are then sent to the appropriate DMM staff person as indicated Table 2-1.

3. The DMM staff person receiving the field-approved permit/license document will conduct a final review of the documents and either authorize the final approval in writing or return the documents to the site mine inspector to obtain additional information or make final corrections. Any documents returned to the operator will be accompanied by written notification specifying the deficiencies or additional information required.

When final approval is granted, the Permit becomes effective upon receipt of appropriate fees and bond and the issuance of a mine permit/license.

4. Where the Mine Inspector Supervisor reviews field-approved amendments and fees or bond adjustments are not required, the Mine Inspector Supervisor may choose to distribute the approved documents. If so, a copy of the amendment form or other approval document will be sent to the applicant, one complete copy of the documents will be sent to the Mine Inspector, and a complete original copy of the permit/license document will be sent to the Program Support Technician in the DMM office for necessary data entry and filing in the permit record. The Program Support Technician copy should have a note attached indicating that the materials have already been distributed.

## **2.4 GENERAL PERMIT FOR SAND AND GRAVEL OPERATIONS LESS THAN TEN ACRES IN SIZE**

The general permit (Form DMM-168) governs the mining of sand, or sand and gravel that affect a total disturbed area of less than 10 acres in size. The general permit is not applicable to dredging operations or those that otherwise intend to mine below the groundwater table.

This permit provides for standards for operations, drainage, and reclamation plans eliminating the need for detailed design plans and narratives. Variations from these standards cannot be granted under this permit. Prospective operators who cannot mine within these guidelines must obtain a permit under the normal permit application process. Those operators that have obtained a general permit and find that actual mining conditions make mining under these guidelines impractical or impossible, such as: 1) mining will impact the groundwater table, 2) haul back of off-site material is necessary or desirable, or 3) where other deviations from the general permit requirements are involved, must submit a

permit amendment requesting the necessary changes to the permit before continuing with mining activities.

The prospective operator must complete a Permit/License Application (Form DMM-101) and provide proof of notification to landowners within 1000 feet of the proposed permit boundary as well as the notifications to the local chief administrative official and any utilities with facilities within 500 feet of the permit boundary.

### **General Terms and Conditions**

The general permit governs the mining of sand, or sand and gravel which affect a total disturbed area of less than 10 acres in size. The general permit is not applicable to dredging operations or those that otherwise intend to mine below the groundwater table.

In order to obtain approval from the Division of Mineral Mining (DMM) for the activity covered under this general permit, the applicant must complete a Permit/License Application (Form DMM-101). No ground disturbance shall take place until the application is approved and the appropriate bond and permit fees are submitted. Additional information may be required based on site-specific conditions.

In addition to the conditions listed below, this permit is subject to all requirements of Chapter 16, Title 45.1 of the Code of Virginia, as amended 1950. Inspections by DMM Mine Inspectors, as required by law, may take place at any time deemed necessary to ensure that all mine activities are in compliance with the terms and conditions of the permit.

In special cases involving public safety or environmental concerns, the DMM Director may deny the application for a general permit and require application for an individual permit.

Issuance of this general permit does not preclude the need to obtain other federal, state or local authorizations as required by law. The general permit may be re-evaluated and/or revoked at any time under circumstances including, but not limited to:

1. Failure to comply with the terms and conditions of the permit.
2. Submittal of a permit application that proves to be false, incomplete, or inaccurate.
3. Change of permit conditions.

Upon re-evaluation, the general permit may remain in effect pending the approval of an amendment or other items to address special circumstances.

The following items must be submitted to DMM with the General Permit application (Form DMM-168):

1. Permit/License Application (Form DMM-101)
2. Permit Notifications (Forms DMM-103, 103A)
3. Certified mail receipts for adjacent property owners within 1000 feet of permit boundary
4. Proof of notification of local administrative officials
5. Proof of notification of utility companies with facilities within 500 feet of permit boundary
6. VDOT Commercial Entrance Permit
7. Permit map drawn to a scale of 400 feet to the inch showing the entire permit area. Map should include: location of the mine pit, main access road, haul roads, product and waste storage areas and all other facilities within the permit; property boundary of tract being mined; property boundaries and names of surface owners within 1000 feet of the permit boundary; sensitive features within 1,000 feet of the permit

boundary such as cemeteries, oil and gas wells, underground mine workings, streams, creeks and other bodies of public water, public utilities and utility lines, public buildings, public roads, churches, and occupied dwellings; drainage flow directions within the permit area; map scale and north arrow.

8. Map legend (Form DMM-109).
9. General location map showing the location of the mine, such as a county highway map or equivalent.

Two copies of each of these documents are required. An explanation needs to be attached for any document not submitted.

### **Off-Site Materials / Hazardous Waste**

Disposal of off-site generated waste materials will not be allowed within the permitted area.

No chemicals or hazardous materials will be stored or allowed on-site.

No trash and/or debris will be allowed to accumulate on-site. All on-site generated waste such as used petroleum products, contaminated fuel, used anti-freeze, used batteries, used cleaning solvents, etc. will be properly stored until disposed of at an approved off-site facility.

### **Signs**

A sign shall be posted at the mining site adjacent to the principal access road. The name of the permittee and the permit number shall be clearly provided on the sign. The dimensions of the sign shall be 4-ft x 4-ft, and it shall be attached to a metal pipe or wood post at a minimum height of four feet above ground level.

### **Marking Of Permit Boundaries**

The permit boundary of the mine shall be clearly marked with identifiable markings when mine related disturbing activities are within 100' of the permit boundary.

### **Roads**

The Virginia Department of Transportation (VDOT) shall approve the access road entrance. The access road will be properly maintained to ensure that mud and debris are not tracked onto public roads. The access road will be at least 15 feet in width and paved with gravel, asphalt or a combination of sand and gravel for a distance of 200 feet from the junction with the public road. All access roads and service roads will be properly maintained to control dust. Maintenance of the road system shall consist of inspecting, repairing and cleaning of roadways, ditches and culverts as necessary. Internal service roads and principal access roads shall be planned to minimize the impact of traffic, dust, and vehicle noise on developed areas outside the mining site.

Road surfaces and ditches will be stabilized with rock or other suitable paving material, or vegetated in the case of ditches. When a road is abandoned, steps shall be taken immediately to minimize erosion and establish vegetative cover. These steps will involve scarifying the road to a depth of 12 inches and seeding to meet the post mining land use requirements. The haul road may be left un-reclaimed with the landowner's approval following the completion of mining.

Sediment control shall be provided for roads to minimize sediment that leaves the permitted and disturbed area. Culverts with a minimum diameter of 12 inches, but adequate to carry storm runoff, will be installed at intervals to prevent overloading of ditches. Where necessary, the inlet end shall be protected by a headwall of a suitable material and the outlet end shall discharge onto an apron of rock riprap or concrete. Runoff will not be allowed to flow over an unprotected fill slope.

### ***Drainageways***

No impacts to natural drainageways shall be allowed. All intermittent or perennial streams shall be protected from spoil by natural or constructed barriers. In the event that a stream crossing is required, a plan will be submitted detailing the crossing.

A 50-foot buffer zone of undisturbed vegetation or undisturbed forest will be provided and maintained on both sides of all streams in the mining area. Buffer zones will be maintained in addition to proper sediment control.

### ***Screening***

Site screening shall be achieved by one or a combination of the following methods:

- 1) 100 feet of undisturbed forest within the permit boundary;
- 2) the use of natural topography;
- 3) constructed berms; and
- 4) tree plantings.

If trees are planted, they will be evergreens of adequate height and suitable to the area. At least two rows will be planted with trees staggered along the rows. The slopes of screening berms will be 3H:1V and seeded immediately to prevent erosion. The toe of the berms shall not be constructed within 25 feet of adjacent property boundaries without written permission from the adjoining property owner. Sediment control for the exterior of berms will be provided by properly installed silt fence. Berms shall be removed and the material used in reclamation following mining.

### ***Mining Method, Topsoil Storage and Drainage Control***

Prior to any land disturbing activities, temporary sediment control will be properly installed where necessary around the perimeter of the area to be disturbed. Topsoil and overburden will be removed and stockpiled or used to create diversion berms around the perimeter of the site. The constructed berms will be no higher than five feet above the natural ground elevation and will have a top width of at least four feet. The side slopes will be 3H:1V or less and will be compacted and vegetated. No topsoil will be removed without prior

approval. Diversion berms will be inspected on a regular basis and maintained as necessary. Berms shall not be constructed within 25 feet of adjacent property boundaries without written permission from the adjoining property owner. Tree roots and limbs generated on-site may be stockpiled within the permit area. As areas are completed, the berms will be utilized to obtain final grade and promote vegetative cover.

Mining will be conducted in such a way as to direct all surface runoff into the pit. All storm-water drainage within the disturbed area will be diverted into the pit. If a drainage outlet is needed, a permit amendment including a design for the outlet will be required.

### ***Mining Below the Water Table***

No mining will take place below the water table without first obtaining approval through an amendment.

### ***Metal and Debris***

All metal, lumber and debris will be stored in one location within the permitted area for use in repair of equipment, or to be sold at a later date. No metal will be left on the site after mining is complete. Any off-site generated metal waste will be promptly removed to an approved landfill. There will be no landfilling activities on the permitted area.

### ***Completed Slopes***

All active slopes will be maintained at the angle of repose (i.e. no steeper than 1H:1V). All final slopes will be graded to 3H:1V or a lesser slope. Reclamation will be conducted concurrently with mining.

### ***Acid Material***

All acid-generating spoil materials will be segregated and buried to a minimum depth of four feet.

### ***Revegetation***

As each area is mined out, it shall be immediately re-graded and vegetated to provide simultaneous reclamation. Compacted soils shall be ripped or scarified to a depth of at least 18 inches prior to seeding. Lime and fertilizer requirements shall be determined by soil testing. Seed selection will be determined in consultation with the DMM mine inspector based on the best post mining land use determination at the time. Constructed wetlands will be considered as a post mining land use only after the operator submits and receives approval for a plan. Tree plantings are encouraged as part of the post mining land use and must occur in forest, unmanaged forest, and wildlife habitat post mining land uses.

### ***Closure Of Roads Or Openings***

Upon abandonment of the mine, the operator shall effectively close or fence all roads, openings, and pits where hazardous conditions exist. Warning signs shall be posted. If fencing is necessary, the fence shall be 4-feet high woven wire with two strands of barbed



wire on top. Intermittently worked mines shall also be closed or barricaded, and posted with warning signs to prevent access to roads and hazardous areas.

**Permit Amendments to a General Permit will be required for:**

1. Mining below the water table.
2. Bringing off-site material on to the permit area.
3. Any other deviation from this general permit.

## **2.5 VIOLATION APPEAL**

### **Procedure For Appeal Of Safety or Reclamation Violations**

These procedures pertain to appeals of violations or decisions issued under authority of the Mineral Mine Safety Laws of Virginia, Title 45.1 Chapters 1-14 and 18, Code of Virginia and Mineral Mine Reclamation Laws, Title 45.1 Chapter 16, Code of Virginia. The basis for such an appeal may be to review the fact of the violation or the procedural action taken to inspect, cite a violation, or issue a decision.

Two types of appeal are available. A request may be made for any Informal Conference as provided for in the Administrative Process Act (APA) Section 9-6.14:11 or the informal conference may be waived and a request may be made to conduct a formal hearing as provided for in APA Section 9-6.14:12. Issues dealing with violations of the Mineral Mine Safety Act are governed by the APA and the *Virginia Supreme Court Hearings Officer System Rules of Administration*. Those issues involving the Mineral Mine Reclamation Law governed by Section 45.1-194 of the Code of Virginia are directed to the Board of Surface Mining Review.

A mine operator or "interested person" as defined in 45.1-2 may appeal any violation under Title 45.1, Chapters 1-14, 16 and 18 of the Mine Safety Act. These appeals must be made in accordance with the following sequence and procedures:

Informal Conference APA Section 9-6.14:11 Pertaining to Safety Violations

Informal Conference APA Section 9-6.14:11 Pertaining to Reclamation Violations

#### **Informal Conference APA Section 9-6.14:11**

A request for an Informal Conference must be made in writing to the DMM Director within 30 days of issuance of the violation. Written requests submitted through the mail will be granted three additional days to allow for delivery. Upon receipt of the request for an informal conference, the DMM Director or authorized representative will take the following actions:

1. Review the request and subject violation to determine if the request for Informal Conference is timely. Untimely requests will be denied and returned to the requester.

2. The Director will assign a Conference Officer. Normally, Mine Inspector Supervisors serve as Conference Officers, but may not serve on conferences within their own assigned territory.
3. The Conference Officer shall contact the conference requester to coordinate and schedule the date, place, and time for holding the Informal Conference. The conference shall be held in the same general locality as the mine site.
4. The DMM Director or authorized representative shall provide written notice to the requester, Mine Inspector, and any other interested persons, notifying them of the date, place, and time of the hearing. Such written notice shall provide at least five days advance notice of the conference unless both parties waive the advance notice requirement.

The Conference Officer shall conduct the Informal Conference to ascertain the facts surrounding the violation. The following shall be allowed as part of the conference:

1. The Conference Officer may tour the portion of the mine that was subject to the violation. Such tour shall be conducted with both parties represented.
2. The requester may appear in person, be represented by counsel, or by other qualified representative and present factual data, argument, or proof in connection with the subject violation or order.
3. DMM may appear represented by counsel, or other qualified and authorized representative, and present factual data, argument, or proof in connection with the subject violation or order.
4. DMM shall provide notice and make available any contrary fact basis or any information in possession of DMM that can be relied upon in making an adverse decision.

The Conference Officer shall provide the DMM Director with a summary of the information presented at the Informal Conference. The summary shall be provided within 20 days following the date of the Informal Conference and shall include the following:

1. Identify the issue under review by the conference. Include the name and company of person requesting the conference and code or regulation section at question.
2. Identify the violation or order under review. Identify the issuing officer, date, time, particular operation, and a description of the violation as cited.
3. Provide the date, time, and place of the Informal Conference and list the names and affiliations of all persons in attendance.
4. Provide a summary of all the facts and evidence presented at the informal conference as well as any physical evidence noted during the site tour.
5. Provide a conclusion and make a recommendation based on information available at the Informal Conference. The recommendation shall clearly state the recommended action to be taken with regard to the subject violation or order.

The DMM Director, upon receipt of the written Informal Conference Summary, shall decide whether to accept or reject the Conference Officer's recommendation. The DMM Director shall then provide written notice of the decision to the conference requester. This decision shall be provided within ten days following receipt of the Informal Conference Summary from the Conference Officer.

The final decision shall be provided by certified mail in the form of a letter with the Informal Conference Summary attached. This letter shall clearly identify the issue at hand, the decision, any action to be taken by DMM, and provide information on the right to appear, the procedure for appeal, and any time limits. The following statement is recommended to address the appeal information:

**Please be advised that \_\_\_\_\_ may seek a formal hearing and review of this decision in accordance with 9-6.14:12 of the Administrative Process Act. You have 30 days following service of this decision to file your request for a formal hearing. If you receive this decision by mail, three days shall be added to the 30-day period. The request for a formal hearing must be made in writing and submitted to the Division Director, Division of Mineral Mining.**

## 2.6 BOND RELEASE

Any company or individual having an unrestricted Virginia mining permit is required to post bond with the State of Virginia through the Division of Mineral Mining. These bonds serve as a guarantee that reclamation will be completed on mineral mining sites. These bonds are refundable when reclamation has been performed and approved by the assigned mine inspector. Generally, reclaimed areas that have gone through two full growing seasons may be considered for Bond Release.

The following procedures are required to obtain a bond release:

1. The mine operator shall contact the Mine Inspector to request a Bond Release Inspection. Such an inspection may be conducted as part of a regular inspection of the mine. The operator and Mine Inspector meet to agree on those areas suitable for Bond Release.
2. The mine operator must prepare two copies of the permit map and color code the areas agreed upon for Bond Release. The map legends need to be complete with the number of acres to be released. The disturbed acreage also needs to be modified to reflect the reclaimed acreage. If the released acreage is to remain as part of the permit (not deleted), then the total permit acreage will be unchanged on the permit map and legend. (See the following examples.)
3. Once the Bond Release Inspection has been made and the maps provided to the Mine Inspector, a Bond Release Form will be completed by the inspector and the documents submitted to the DMM office for processing.
4. DMM will process the request and the released bond will be returned to the permittee. A copy of the Bond Release Inspection Form will also be sent to the permittee.

Two Bond Release Permit Map examples are provided below.

**Example #1**—Bond Release for twenty-two acres, which are **to remain** on permit. Refer to example #1 form and Figure 2-1.

ABC Mining Company has a mineral mining permit with a total permitted area of 100.00 acres and a bonded area of 40.00 acres. They desire to obtain a bond release on 22 acres of reclaimed mine land currently under bond. The company also desires to maintain this acreage under their mineral mining permit.

ABC Mining Company prepares a permit map showing the 100.00 acres covered by the permit (outlined in red). Within the permitted area the company shows the 22.00 acres where bond release is desired (cross-hatch green) and the 18.00 disturbed acres to remain under bond (solid yellow).

On the Map Legend the company indicates in the appropriate blank the total number of acres covered by the permit (100.00). They also indicate in the appropriate blank the total number of acres currently bonded (40.00) and minus the number of acres they are request to be released from bond (22.00) and show the number of acres that will be bonded after bond release (18.00). Finally, the number of acres that are suitable for bond release are indicated in the appropriate blank.

**Example #2**—Bond Release for 22 acres, which are **to be deleted** from the permit. Refer to the Example #2 form and Figure 2-2.

ABC Mining Company has a mineral mining permit with a total permitted area of 100.00 acres and a bonded area of 40.00 acres. They desire to obtain a bond release of 22.00 acres of reclaimed mine land currently under bond and also desire to delete this 22.00 acres from their mining permit.

ABC Mining Company prepares a permit map showing the 100.00 acres covered by the permit (outlined in red). Within the permitted area the company shows the 22.00 acres where bond release and deletion from the permit are desired (cross-hatch green/cross-hatch red) and the 18.00 disturbed acres to remain under bond (solid yellow).

On the Map Legend the company indicates in the appropriate blank the total number of acres currently covered by the permit (100.00) minus the number of acres to be deleted from the permit (22.00) and showing the new total permitted acres (78.00). They also indicated in the appropriate blank the total number of acres currently bonded (40.00) minus the number of acres they are request to be released from bond (22.00) and show the number of acres that will be bonded after bond release (18.00). The number of acres that are suitable for bond release and permit deletion (22.00) are indicated in their corresponding blanks.



Figure 2-1: Example #1, Bond Release Without Acreage Deletion

### Bond Release Without Deletion

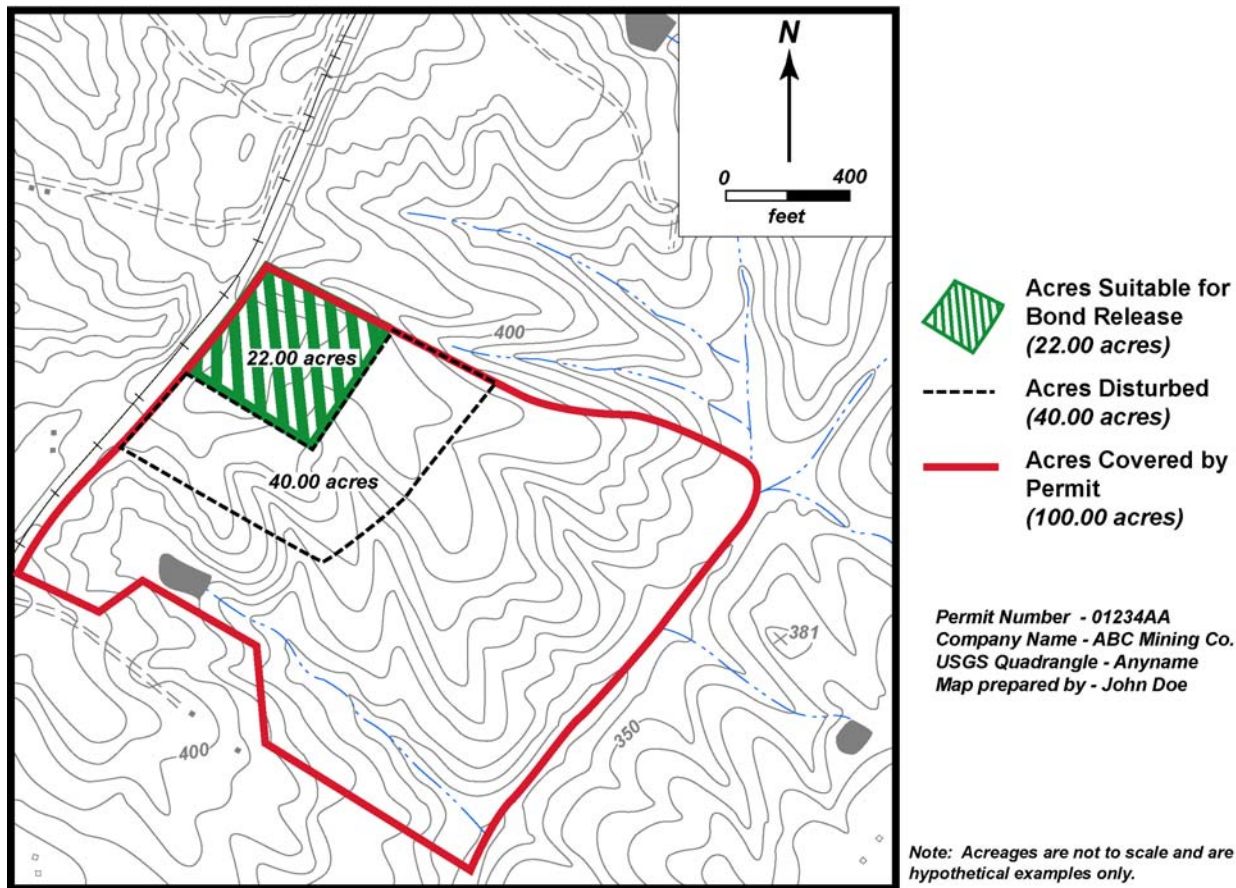

### Example #2: Bond Release with Acreage Deletion

COMMONWEALTH OF VIRGINIA  
DEPARTMENT OF MINES, MINERALS & ENERGY  
DIVISION OF MINERAL MINING  
900 Natural Resources Drive, Suite 400  
Charlottesville, Virginia 22903  
434-951-6310

- |  |  |   |
|--|--|---|
| <input type="checkbox"/> Application Map                 | <input type="checkbox"/> Renewal Map             | <input type="checkbox"/> Amendment Map      |
| <input type="checkbox"/> Completion Map                  | <input checked="" type="checkbox"/> Bond Release | <input type="checkbox"/> Relinquishment Map |
| <input type="checkbox"/> Combined Safety/Reclamation Map |  |   |

#### LEGEND

Permit Number 01234AA County Anywhere  
 Company Name ABC Mining Co.  
 Map Scale 1"= 400' USGS Quadrangle Misnomer

#### COLOR CODE

Outline Red	No. of acres covered by this permit <u>100.00 - 22 = 78.00</u>
Yellow	No. of acres disturbed, including access roads <u>40.00 - 22 = 18.00</u>
Brown	No. of additional acres to be disturbed during the next 12 months _____
Cross-Hatch Green	No. of acres suitable for bond release (must be approved by Inspector) <u>22</u>
Green	No. of acres vegetated during the last 12 months _____
Cross-Hatch Red	No. of acres deleted from the permit <u>22</u>
Cross-Hatch Black	No. of reclaimed acres with bond released previously _____
Cross-Hatch Purple	No. of acres relinquished _____
Blue	Water and drainage pattern

Map prepared by \_\_\_\_\_

L. S. Reg. No. \_\_\_\_\_ VA P. E. Reg. No. \_\_\_\_\_ VA

I, the undersigned, hereby certify this map is true and accurate, showing to the best of my knowledge and belief, all information required by Virginia Mineral Mining Law.

_____	_____
Signature	Date



Figure 2-2: Bond Release with Acreage Deletion

### Bond Release With Deletion

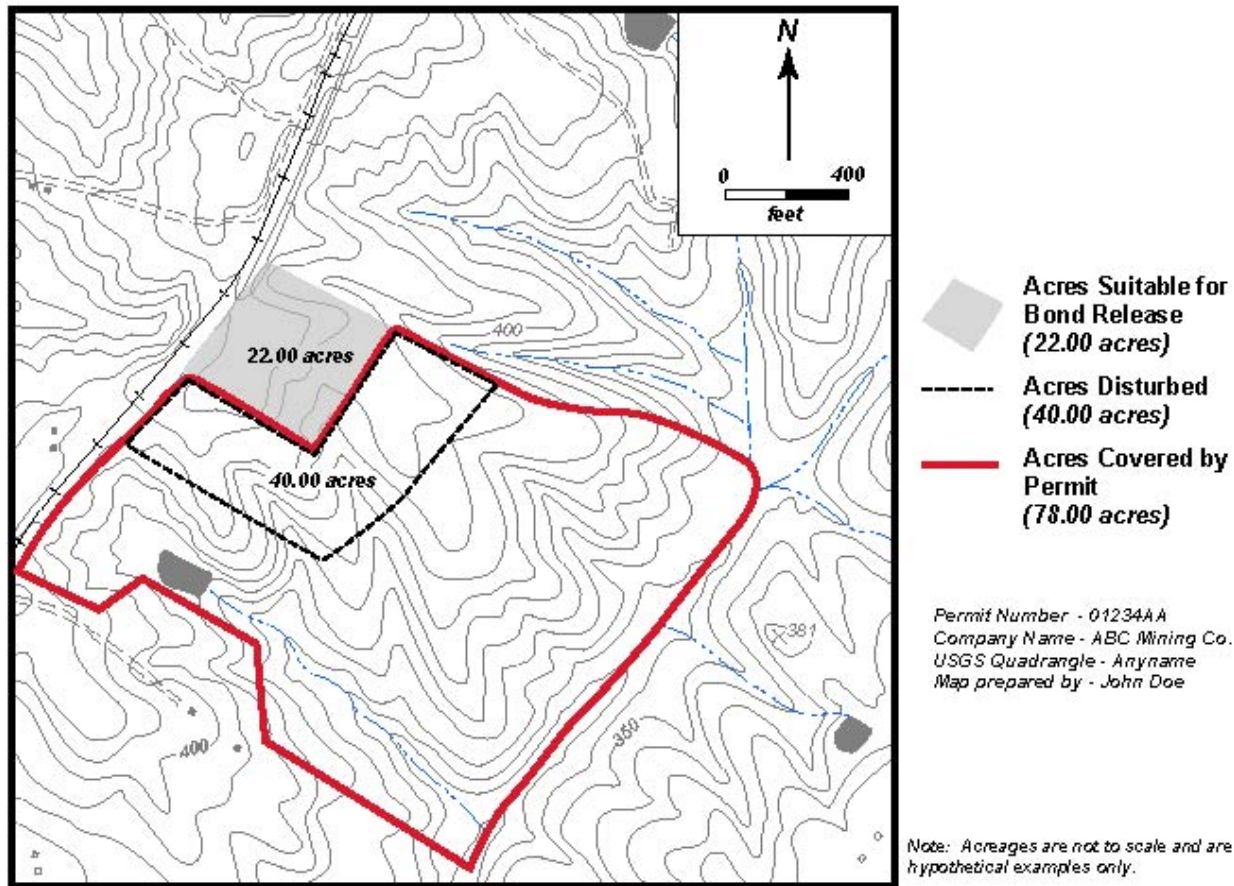



## 2.7 TEMPORARY CESSATION

Mines may be idled for extended periods of time. Temporary cessation is a permit status granted to surface mining operations under the *Reclamation Regulations for Mineral Mining* Section 4VAC25-30-400B where the mine operator intends to remain idle for a continuous period of at least 12 months, while maintaining a current permit/license under the provisions of Title 45.1 Chapter 16.

### Request for Temporary Cessation

When the mine operator anticipates inactivity at a mine for a period in excess of 12 months the operator will contact the mine inspector to arrange a site visit to discuss temporary cessation. During the site visit, steps necessary to comply with 4VAC 25-30-400 B.1 through 4 of the Mineral Mining Regulations should be discussed with the mine inspector. Specific items of discussion should include those measures listed below. Specific time frames to implement these measures should also be established at this meeting.

Surface regrading must be current with the operation and reclamation plan.

Exposed toxic or toxic forming materials must be covered with a minimum of four feet of non-toxic material, capable of supporting vegetative cover.

All approved re-graded areas must be revegetated.

Areas that will be redisturbed shall be revegetated with temporary cover.

All drainage structures must be in place and properly maintained. Drainage structures must be inspected at least monthly and after every major storm event to insure their proper function and integrity.

Ponding of water in the mine pit will not be allowed unless stipulated as part of the post-mining land use of ponds or lakes.

All mobile equipment will be removed from the permit and portable stationary equipment will be removed where deemed necessary. Permanent stationary equipment will be in acceptable working order, properly maintained, and fenced or barricaded where necessary to prevent unauthorized access.

All supplies of fuel, oil, and lubricants shall be removed from the mine and metal, lumber and other miscellaneous debris will be properly disposed of.

All access roads will be closed or barricaded and quarry walls shall be fenced in compliance with *Mineral Mine Safety & Health Regulation* 4VAC25-40-300. Pit walls shall be sloped in accordance with the approved operational plan to eliminate hazards and vegetated to prevent erosion and slope failures.

The operator must submit a written request for temporary cessation. The request must include the following:

1. A completed Request for Amendment (DMM-113) form;
2. A statement of justification for requesting temporary cessation;
3. The date that the mine last operated;

4. The anticipated date that operations will resume, not to exceed one year;
5. A narrative detailing what measures will be taken to comply with Section 4VAC25-30-400B.1 through 4 and the time frame for completion of these measures; and
6. A certification statement that states:

***“I hereby certify that the information provided herein and all attachments submitted herewith are true to the best of my knowledge and belief. I understand that this temporary cessation does not relieve any of my obligations under Title 45.1 of the Code of Virginia or provisions of the approved permit. I will notify DMM in writing 10 days prior to resumption of mining activities. I realize that this notice will expire on (the date shown in response to item 4 above\_.”***

Temporary cessation status is subject to review at the end of the requested temporary cessation period. Operations that have existed in temporary cessation status for more than 12 months will be required to submit additional information to support temporary cessation renewal, including evidence of recoverable reserves and ability to mine those reserves. Temporary cessation for more than 12 months may require additional re-grading and revegetation to meet the approved post mining land use

## 3 FORMS

Section 3 describes the most commonly used DMM forms. A copy of each form is provided. Each form has a specific purpose such as for the submittal of a permit application, renewal of a permit, submission of an amendment, or when corresponding with the Division. It is important that these forms be properly filled out with all necessary information to eliminate the need for untimely delays in processing due to resubmittal of information. Short explanations of the use for each form are provided and line by line instructions for filling-out each form are included. Electronic copies of forms can be downloaded from the internet at [www.dmme.virginia.gov/dmm](http://www.dmme.virginia.gov/dmm).

### 3.1 NOTICE OF OPERATOR INTENT—FORM DMM-156

Section 45.1-161.292:36 of the *Mineral Mine Safety Laws of Virginia* requires all licensed operators to notify the Division when changes occur in the operating status of their mine. The Notice of Operator Intent (DMM-156) may be used to inform the Division of the following events:

- Discontinuing work in an underground mining operation for a period of 30 days or more;
- Discontinuing work on a surface mining operation for a period of 60 days or more;
- Ten day notice of resuming work at an inactive surface or underground mining operation;
- Emergency action taken as of date at an inactive mine to preserve the mine;
- Changes in mine name or name of operation not affecting permit status; and
- Effective date of new mine opening.

Instructions for completing DMM-156 are provided in Table 3-1. A copy of form DMM-156 is provided as Figure 3-1.

**Table 3-1: Form DMM-156 Instructions**

<b>Name of Operator</b>	Must coincide with the persons authorized to sign permit/license documents as indicated on the Permit/License Application, DMM-101.
<b>Permit Number</b>	Provide the five-digit and two-letter permit number that was assigned when the current permit was issued.
<b>Company Name</b>	Provide the name of the company as it appears on the mine permit issued by DMM.
<b>Address</b>	Provide the current mailing address where DMM correspondence is sent.
<b>Telephone Number</b>	Provide current telephone number of office or other facility where you can be reached during the mine closure. Do not list the mine office phone number.
<b>Location of Mine</b>	Give a verbal description of the location of the mine including such items as county or city, distance from state road intersections.

**Figure 3-1: Form-DMM156**



**COMMONWEALTH OF VIRGINIA  
DEPARTMENT OF MINES, MINERALS AND ENERGY  
DIVISION OF MINERAL MINING  
900 Natural Resources Drive, Ste. 400  
Charlottesville, VA 22903  
(434) 951-6310**

**NOTICE OF OPERATOR INTENT**

Name of Operator \_\_\_\_\_ Permit No. \_\_\_\_\_  
Company Name \_\_\_\_\_  
Address \_\_\_\_\_  
\_\_\_\_\_ Telephone No. \_\_\_\_\_  
Location of Mine \_\_\_\_\_  
\_\_\_\_\_

In accordance with section 45.1-161.292:36, we hereby serve notification of our intent to proceed as noted below:

- { Working will be discontinued for a period of 30 days or more at our underground mining operation.
  - { Working will be discontinued for a period of 60 days or more at our surface mining operation.
  - { Working will resume at our inactive mine 10 days following the effective date of this notice.
  - { Emergency actions were taken on (Date) \_\_\_\_\_ to preserve this mine.
- Describe:
- { The mine name or name of the operation of the mine will change, as noted below, 10 days following the effective date of this notice.

**Current Information**

**New Information**

_____	_____
_____	_____
_____	_____

- { Our new mine will open ten days following the effective date of this notice.

The effective date of this notice is \_\_\_\_\_.

Operator/Agent \_\_\_\_\_

DMM-156  
REV. 02/06

### 3.2 REQUEST FOR AMENDMENT—FORM DMM-113

Form DMM-113 is used when the permittee wishes to make a change, addition, or deletion to their Application/Operations/Drainage/Reclamation Plan. The top half of this form is completed by the permittee and the DMM Mine Inspector will complete the remainder of the form.

Normally the amendment form is submitted with attachments provided by the permittee to justify the proposed changes to the permit. Some examples of attachments would be narratives, engineering data, drawings, drainage control specifications, maps, and cross sections of existing or proposed structures.

Table 3-2 gives a brief item-by-item explanation of the amendment form. A copy of the form DMM-113 is provided as Figure 3-2.

**Table 3-2: Form DMM-113 Instructions**

<b>Company Name</b>	Must coincide with the name indicated on the Application /Operations Plan.
<b>Permit Number</b>	Provide the five-digit and two-letter permit number that was assigned when the current permit was issued.
<b>Operating Official</b>	Must coincide with the persons authorized to sign permit/license documents as indicated on the Permit/License Application, Form DMM-101.
<b>Title</b>	This is the position within the company that is held by the person signing the amendment form.
<b>Amendment Requested</b>	This space is provided for the mine operator to define the request. Clearly indicate the purpose of the amendment; for example: Adds 10 acres to permit area. Adds two acres to disturbed area. Deletes five acres from permit area. Changes operation plan.
<b>List of Attached Items</b>	This space is provided for the mine operator to list items attached/enclosures submitted with the amendment. Example: Revised Map Pond Design Data Operation Narrative State Forms
<b>Operator's Signature/Date</b>	A company official who is registered with DMM and authorized to sign documents on behalf of the company must sign the amendment.

DMM personnel shall complete the remainder of the form below the Operator's Signature/Date.

**Figure 3-2: Form DMM-113**



**COMMONWEALTH OF VIRGINIA  
DEPARTMENT OF MINES, MINERALS AND ENERGY  
DIVISION OF MINERAL MINING  
900 NATURAL RESOURCES DRIVE, STE. 400  
CHARLOTTESVILLE, VIRGINIA 22903  
(434) 951-6310**

**REQUEST FOR AMENDMENT**

**Company Name:** \_\_\_\_\_ **Permit No.:** \_\_\_\_\_

**Operating Official:** \_\_\_\_\_ **Title:** \_\_\_\_\_

---

**An Amendment Is Requested to This Permit As Listed Below:**

---

**List of Attached Items:**

**Operator's Signature:** \_\_\_\_\_ **Date:** \_\_\_\_\_

---

**Inspector's Comments/Recommendations:**

**Inspector's Signature:** \_\_\_\_\_ **Date:** \_\_\_\_\_

---

**FOR OFFICE USE ONLY**

**Sent Back for Revision and/or Additions As Indicated On Attached Letter.**

**Signature:** \_\_\_\_\_ **Date:** \_\_\_\_\_

---

**Amendment:**             **Approved**                     **Disapproved**

**Signature:** \_\_\_\_\_ **Date:** \_\_\_\_\_

**DMM-113  
REV. 02/06**

### 3.3 CONTRACTOR IDENTIFICATION —FORM DMM-166

Section 45.1-161.292.32 of the *Mineral Mine Safety Laws of Virginia* requires that the licensed operator provide information regarding contractors working on their mine sites at each renewal time and report any changes to this information throughout the year whenever the information changes. As required by law these changes must be provided to the Division within 30 days of their occurrence. The Contractor Identification Form may be used to notify the Division of new contractors working on the mine site and may also be attached to the License Renewal Application in response to question four. Item by item instructions for completing DMM-166 are provided in Table 3-3. A copy of the form is provided as Figure 3-3.

**Table 3-3: Form DMM-166 Instructions**

Licensed Operator Information	
<b>Company</b>	Name of the company as it appears on the permit.
<b>Permit Number</b>	Provide the five-digit and two letter permit number that was assigned when the current permit was issued.
<b>Location of Work</b>	Identify those areas of the mine where the contractor will be performing their work (ex. Quarry, shop, processing area).
<b>Date contractor began work</b>	Give the date that the contractor first came on site. If provided at renewal, give the anniversary date of the permit.
<b>Date information provided DMM</b>	Give current date.
<b>Person providing information</b>	Provide name of mine official or agent who notified the DMM of the contractor's presence on the mine site.
<b>Signature</b>	Signature of person authorized to sign DMM documents for the company.
<b>Date</b>	Provide the date the form was signed.
Contractor Information	
<b>Contractor Trade Name</b>	Company name of contractor working on the mine site.
<b>Business Address</b>	Provide the mailing address for the person, company, or corporation working on the mine site.
<b>Business Telephone</b>	Daytime business telephone number where the person, company, or corporation can be reached.
<b>DMM Contractor No.</b>	Provide if available and known. The DMM mine inspector or the DMM office may be able to assist in providing this information.
<b>Contractor's MSHA Identification No.</b>	Provide if available. Not all contractors working on mine sites are required to have an MSHA ID.
<b>Address of Record</b>	Indicate if different from business address.
<b>Services to be provided</b>	Provide a summary of the work that the contractor will perform on the mine site. Be specific to the mine site.
<b>Contact: operating decisions</b>	Provide name and address of person responsible for making operational decisions for the contractor.
<b>Contact: health &amp; safety</b>	Provide name and address of person responsible for safety and health matters including training.

### Figure 3-3: Form DMM-166

## CONTRACTOR IDENTIFICATION FORM

Section 45.1-161.292.32 of the Mineral Mine Safety Laws of Virginia requires that the applicant for a mine license include information about contractors working at the mine and keep the information current by reporting any change within 30 days. This sheet may be attached to the License Renewal Application in response to Question 4.

### Licensed Operator Information

COMPANY \_\_\_\_\_ PERMIT # \_\_\_\_\_

Location at mine where work is to be done \_\_\_\_\_

Date contractor began work on the mine \_\_\_\_\_

Date contractor information was provided to the Division of Mineral Mining in writing \_\_\_\_\_

Person who provided the information \_\_\_\_\_

\_\_\_\_\_  
SIGNATURE OF LICENSED MINE OPERATOR

\_\_\_\_\_  
DATE

---

### Contractor Information

Contractor's Trade Name \_\_\_\_\_

Business Address \_\_\_\_\_

Business Telephone Number \_\_\_\_\_

DMM Contractor # \_\_\_\_\_ Contractor's MSHA Identification # \_\_\_\_\_

*(Note: Not all contractors are required to have a DMM Contractor ID or MSHA ID number. This information should be provided if applicable.)*

Address of Record for Service of Citations and Other Documents \_\_\_\_\_

List services to be provided to the mining company:  
\_\_\_\_\_

Contractor person with responsibility for operating decisions:

Name

Address

\_\_\_\_\_

\_\_\_\_\_

Contractor person responsible for health and safety of employees:

Name

Address

\_\_\_\_\_

\_\_\_\_\_

DMM-166  
Rev. 10/31/02



### **3.4 ANNUAL REPORTING—FORMS DMM-146 & DMM-146C**

Between January 1<sup>st</sup> and February 15<sup>th</sup> of each year, licensed operators and independent contractors must report production tonnage, worker hours, and wage information for the previous calendar year (January 1<sup>st</sup> through December 31<sup>st</sup>). Forms DMM-146 (for licensed operators) and DMM-146C (for independent contractors) are required to be used to submit this information.

These reports are required by Section 45.1-161.292:35 of the Code of Virginia. Failure to provide complete and accurate information may lead to permit revocation, denial of license renewals, or prohibition from working on mineral mines within the Commonwealth of Virginia. These may be submitted to the site Mine Inspector or directly to the DMM Charlottesville office.

#### **Annual Tonnage Report, Form DMM-146**

All licensed operators who have a current DMM permit/license must submit the Annual Tonnage Report (Form DMM-146). The licensed operator should maintain accurate records pertaining to production tonnage, workers hours and wages throughout the year to ensure timely completion of the Annual Tonnage Report. Contractors who perform all of the mining activities on a mine site must provide the licensed operator with production information (quantity of minerals mined). Table 3-4 provides line-by-line instructions for completing Form DMM-146. Figure 3-4 provides a copy of form DMM-146.

#### **Mineral Mining Annual Report for Contractors, Form DMM-146C**

Section 45.1-161.292:35.B of the *Mineral Mine Safety Laws of Virginia* requires that all independent contractors who perform 1) extraction and processing, 2) maintenance and repair of mobile and stationary equipment, or 3) performs mine construction, such as plant construction, electrical work, concrete fabrication and plant repair or maintenance on a mineral mine in Virginia to submit an annual report to the Division no later than February 15th of each year.

The report shall be for the work performed on each mineral mine during the preceding 12-month period, ending on December 31st. Independent contractors covered by this requirement should keep accurate records regarding which mines they have performed work on; the total number of employees who have worked at each mine; the total number of hours worked at each mine; and the total wages paid to employees working at each mine. Table 3-5 provides line-by-line instructions for completing Form DMM-146C. Figure 3-5 provides a copy of form DMM-146C.

**Table 3-4: Form DMM-146 Instructions**

<b>Report for Calendar Year</b>	Normally the dates to be entered here will be January 1st of the reporting year to December 31st of the reporting year. The beginning date may vary if the permit was only issued for part of the year or if the permit was transferred to a new licensed operator. The report must be completed by each licensed operator for the portion of the year they held the permit.
<b>Company Name</b>	Provide the name of the company as it appears on the mine permit issued by DMM.
<b>Permit Number</b>	Provide the five-digit and two-letter permit number that was assigned when the current permit was issued.
<b>Total Tons Produced</b>	List the total tons of mineral removed from the mine by company and any and all contractors performing mining activities. The information must be provided in tons of mineral removed from the permit. If cubic yards of mineral removed are known, the conversion chart in Appendix B (Unit Weight of Typical Minerals/Rocks) of this manual may be used to convert this value to tons of mineral removed. If no mineral was removed from the mine, the operator must still file this report and show "0" tonnage.
<b>Workers Information</b>	In this section, divide the number of employees, hours worked, and wages paid into the two categories for office and pit/plant workers. Where information is not applicable such as when there are no office workers or the site has no activity enter "0". All mineworker's hours and wages must be reported. Also, the hours and representative wages for a self-employed one-man operation must be provided. Information must be provided as accurately as possible and may be reasonably estimated in some instances.
<b>Signed</b>	The signature of the licensed operator, an officer, owner, or other designated official of the company is required to certify the accuracy of the information provided.
<b>Title</b>	Provide the current title of the person signing this form (i.e., owner, president, vice president, etc).
<b>Date</b>	Provide the date this report is signed.

**Figure 3-4: Form DMM-146**



**COMMONWEALTH OF VIRGINIA  
DEPARTMENT OF MINES, MINERALS AND ENERGY  
DIVISION OF MINERAL MINING  
900 Natural Resources Drive, Ste. 400  
Charlottesville, VA 22903  
(434) 951-6310**

**MINERAL MINING ANNUAL TONNAGE REPORT**

**REPORT FOR CALENDAR YEAR \_\_\_\_\_**

1. **COMPANY NAME \_\_\_\_\_ PERMIT NO. \_\_\_\_\_**
2. **TOTAL TONS PRODUCED \_\_\_\_\_**
3. **WORKERS—Include the number of full or part-time persons who worked for any part of the period covered by this report. Include all owners, officers, clerical help, engineers and others who worked at the mine.**

<b>NUMBER OFFICE WORKERS</b>	<b>OFFICE HOURS</b>	<b>OFFICE WAGES</b>	<b>NUMBER PRODUCTION WORKERS PIT/PLANT</b>	<b>PRODUCTION HOURS</b>	<b>TOTAL PRODUCTION WAGES</b>

**REPORT REQUIRED BY LAW—Code of Virginia, Title 45.1, Chapter 14.4:1, Section 45.1-161.292:35.A requires this form to be filled out and returned to this office by the 15th day of February. Operations that do not submit tonnage reports may be subject to closure.**

**I, the undersigned, hereby certify that all information provided on this report is true and accurate to the best of my knowledge and belief. I further certify that all occupational injuries occurring on the mine site have been reported for calendar year \_\_\_\_\_.**

**SIGNED \_\_\_\_\_ TITLE \_\_\_\_\_ DATE \_\_\_\_\_**

**PLEASE PRINT YOUR NAME \_\_\_\_\_**

**DMM-146  
REV. 02/06**

**Table 3-5: Form DMM-146C Instructions**

<b>Report for Calendar Year</b>	The report year runs from January 1st to December 31st. Any work performed covered under the three categories mentioned above on any mineral mine site must be included for the calendar year.
<b>Contractor Name</b>	Provide the name of the company.
<b>DMM Contractor identification No.</b>	Provide the seven-digit contractor identification number assigned to the company by the Division of Mineral Mining.
<b>Mine Company Name</b>	List all mining companies where the contractor has provided reportable services for the reporting period.
<b>DMM Permit Number</b>	List all individual mine sites by their Division of Mineral Mining Permit Number. These numbers can be obtained from the company officials or from supervisory personnel at the individual mines.
<b>Workers Provided</b>	List the total numbers of workers employed by the contracting company that worked at each mine during the reporting period.
<b>Hours Worked</b>	List the total number of hours that workers employed by the contracting company worked at each mine during the reporting year.
<b>Total Wages</b>	List the total amount of wages paid to workers employed by the contracting company at each mine during the reporting year. Where the total amount of wages paid at any mine is less than \$1,000 these wages need not be reported.
<b>Accident Reporting Calendar Year</b>	Section 45.1-161.292:52.B of the <i>Mineral Mine Safety Laws of Virginia</i> requires all independent contractors to report all occupational injuries to the Division during each calendar year. The report year should be provided in this space and represents certification that all such injuries have been properly reported.
<b>Signed</b>	The signature of the officer, owner, or other designated company official is required to certify the accuracy of the information.
<b>Title</b>	Provide the current title of the person signing this form (i.e., owner, president, vice president, etc).
<b>Date</b>	Provide the date this report form was signed.



### 3.5 YEARLY PROGRESS REPORT—FORM DMM 105

All Mineral Mining Permit/Licenses must be renewed annually. At least 90 days prior to the renewal date, the Division of Mineral Mining provides notice to the operator of the upcoming renewal. This Renewal - Special Order Notice includes deadline dates for submittal of the Renewal, fee schedules, and copies of the forms that need to be completed to renew the Permit/License. The required forms include the Yearly Progress Report (Form DMM-105), the Map Legend (Form DMM-109), the License Renewal Application (Form DMM-157) and Contractor Identification Form (Form DMM-166). Table 3-6 provides line-by-line instructions for completing form DMM-105. Figure 3-6 provides a copy of form DMM-105.

**Table 3-6: Form DMM-105 Instructions**

1.		No response is necessary to this item. It is merely a statement from the DMM stipulating the Section of the Code of Virginia requiring the information and the final date for submittal of this information without closure and/or bond forfeiture action by DMM.
2.		Removal of any metal, lumber, and other debris from the permit area as part of routine site maintenance or on going reclamation.
3.		Acres Reclaimed Last 12 Months requires the operator to calculate the number of acres:
	<b>A.</b>	<b>Re-graded:</b> This includes those areas that have been backfilled, graded, and contoured.
	<b>B.</b>	<b>Vegetated, (but not released):</b> This includes all areas where final regrading has been achieved and the areas have been vegetated; however, due to insufficient time for vegetation to become established or due to inadequate vegetative cover, the area has not been released from bond by the site Mine Inspector.
	<b>C.</b>	<b>Approved by Mine Inspector during the past 12 months and eligible for release or otherwise released:</b> This includes areas where final regrading has been achieved and the areas have been adequately vegetated or the post-mining land use has been achieved (e.g., wildlife area, lake, or residential use), and the Mine Inspector has approved Bond Release.
The operator should keep records of all vegetation materials (D, E, F & G) used during reclamation operations. These shall be reported yearly as follows:		
	<b>D.</b>	<b>Fertilizer:</b> Report the total amount of fertilizer in tons, and the analysis (Nitrogen, Phosphorus, Potassium) of fertilizer applied. (For example, two tons of 10-10-10.)
	<b>E.</b>	<b>Lime:</b> Report the amount in total tons applied.
	<b>F.</b>	<b>Tree Seedlings:</b> Report the tree seedlings planted, using their common names, total number planted, and the dates that planting took place.
		<b>Grasses/Legumes:</b> Report the grasses and legumes seeded using their common names, total number of pounds sown, and the date(s) that seeding took place.
4.		The <b>number of acres covered by this permit</b> is the total acreage currently on file with DMM. This is the number of acres that the Yearly Progress Report is based on and is provided on the form when it is sent to the operator. No alterations, either additions or deletions, can be made to this calculated acreage. If additional permit area is needed or if the operator desires to remove acreage from the permit, an

		amendment must be prepared and submitted to the DMM Office for approval.
	<b>A.</b>	<b>Acres under bond the previous year</b> is the total acreage currently bonded as recorded by DMM. This is provided on the form when it is sent to the operator. This figure includes disturbed acreage and acreage listed as to be disturbed on the previous year's progress report.
	<b>B.</b>	<b>Additional acreage to be affected the next 12 months</b> is the additional permitted acreage that the operator is requesting to be bonded for the next 12 months. This would include all areas not currently bonded that the operator anticipates disturbing, or using for any mining purpose within the coming year.
	<b>C.</b>	<b>Acres vegetated the past 12 months or acres otherwise released</b> are the total acreage that is currently under bond and approved for release by the Mine Inspector at the reporting time.
<b>Total Renewal Acreage = (A + B - C)</b>		
Where:	A=acres under bond previous year B=additional acres to be bonded next 12 months C=acres to be released from bond	
This calculation determines the number of acres that must be renewed and bonded for the next 12-month period.		
<b>5.</b>		The Operator must check this item if there have been any changes in the company name, address, organizational structure (e.g., change in partnership, ownership, merger), or company officials (e.g., board member, operating official). The operator must be specific in describing any changes relating to the company on the License Renewal Application (DMM-157), which must also be submitted with the renewal.
<b>6.</b>		The name and title of the official in charge of mining operations shall be identified.
		<b>The Yearly Progress Report</b> shall be signed by a company official or by a person duly authorized to represent the company.

**Figure 3-6: Form DMM-105**



**COMMONWEALTH OF VIRGINIA  
DEPARTMENT OF MINES, MINERALS AND ENERGY  
DIVISION OF MINERAL MINING  
900 NATURAL RESOURCES DRIVE, STE. 400  
CHARLOTTESVILLE, VIRGINIA 22903  
(434) 951-6310**

**YEARLY PROGRESS REPORT**

COMPANY: \_\_\_\_\_ PERMIT NO.: \_\_\_\_\_ COUNTY: \_\_\_\_\_

1. The following report is required by Section 45.1-185, Code of Virginia. This section requires that this information be provided by the operator within 10 days following the anniversary date of the issuance of any permit.

2. **COMPLETE BELOW**

Have metal, lumber, and other debris been removed?      Yes      No

3. **ACRES RECLAIMED LAST 12 MONTHS:**

- A. Re-graded \_\_\_\_\_
- B. Vegetated, (but not released) \_\_\_\_\_
- C. Approved by Mine Inspector during the past 12 months and eligible for release or otherwise released (SHOWN HERE AND IN 4 C BELOW) \_\_\_\_\_
- D. Fertilizer (Total) \_\_\_\_\_
- E. Lime (Total) \_\_\_\_\_
- F. Tree Seedlings:
  - Species \_\_\_\_\_ Amount \_\_\_\_\_ Date \_\_\_\_\_
  - Grasses/Legumes:
    - Species \_\_\_\_\_ Amount \_\_\_\_\_ Date \_\_\_\_\_
    - Species \_\_\_\_\_ Amount \_\_\_\_\_ Date \_\_\_\_\_
    - Species \_\_\_\_\_ Amount \_\_\_\_\_ Date \_\_\_\_\_

4. Number of acres covered by this permit (DMM Records): . . . . .

**BOND ACREAGE CALCULATION:**

- A. Acres under bond the previous year (DMM Records): \_\_\_\_\_
- B. Additional acreage to be affected the next 12 months: \_\_\_\_\_
- C. Acres vegetated the past 12 months (acreage has to be approved by Inspector) or acres otherwise released: \_\_\_\_\_
- TOTAL RENEWAL ACREAGE (A + B - C)** \_\_\_\_\_

5. Have there been any changes in Company name, address, organizational structure or Company officials?  
No      Yes      Specify, if yes: \_\_\_\_\_

6. Official in charge of mining operations: \_\_\_\_\_

Title: \_\_\_\_\_

Signature: \_\_\_\_\_ Date \_\_\_\_\_





### 3.6 LICENSE RENEWAL/TRANSFER APPLICATION—FORM DMM-157

The License Renewal/Transfer Application is submitted by mine operators either to renew their Mineral Mine Permit/License, to transfer an existing permit/license or by mine operators in waived localities to apply for a mine license.

The License Renewal/Transfer Application must be submitted each year at renewal time and must be updated as necessary to show any changes in the information on file. The License Renewal/Transfer Application is provided as part of the Permit/License renewal package.

Operations where there have been no changes in the license information must complete questions one, two, three and four, sign and date the form, and submit it to the DMM. **Changes to the license information are generally required by law to be reported to DMM within 30 days of the change having taken place.** Changes may be reported by submitting a signed original letter or by completing and signing the License Renewal Application Form. Forms may be obtained from the DMM office at (434) 951-6314, the DMME webpage at [www.dmme.virginia.gov/dmm](http://www.dmme.virginia.gov/dmm) or from the site Mine Inspector.

Operations where the license information has changed, but the changes have not been reported to DMM, must complete questions one, two, three and four and any other questions necessary to reflect the revised information. The form should then be signed, dated, and submitted to DMM.

The License Renewal/Transfer Application (Form DMM-157) is also to be used to make application for the transfer of an existing permit. The completed application should be accompanied by DMM-112 (Relinquishment of Mining Permit) and DMM-161 (Permit Transfer Acceptance). Table 3-7 provides line-by-line instructions for completing form DMM-157. Figure 3-7 provides a copy of form DMM-157.

**Table 3-7: License Renewal/Transfer Application (Form DMM-157) Instructions**

1.		Provide the name of the applicant as shown in the original permit application unless the company structure has changed and the changes are being reflected in the remainder of the License Renewal Application.  Also provide the complete Mine Permit No. (five numbers and two letters).
2.		Provide the current mailing address where Permit/License notices are to be sent.
3.		Provide a current telephone number where contact can be made regarding the mining operation.
4.		Please provide the names, addresses, and telephone numbers of any independent contractors that will be performing work on the mine site. For each contractor, also provide the name of the contact person and the type of work the contractor will perform on the mine site. An independent contractor generally provides supervision for its own workers and is responsible to the mine operator for the final outcome of the work. Only independent contractors need to be reported in this section.
5.		Provide the type of organization that is applying for the Permit/License and answer

		only the questions in A through N that apply to the particular application type checked.
	<b>A.</b>	If the mine is to be identified by a specific name or number please list the name or number here and give the mailing address of the mine if different than the address provided in item 3.
	<b>B.</b>	Provide the Mine Safety and Health Administration (MSHA) identification number for the mine (if applicable). All mines may not require an MSHA identification number. New mines cannot obtain an MSHA identification number until construction is initiated. The response here needs to indicate that either an MSHA identification number is not needed or that the number will be obtained and provided as a condition of the permit.
	<b>C.</b>	Provide the name, title, address, and phone number of the person responsible for operating decisions for the mine. This person is normally considered the mine operator and makes major decisions involving the mine's operation.
	<b>D.</b>	List the name, address, and telephone number of the person to be contacted in the event of an accident or emergency.
	<b>E.</b>	List the name, address, and telephone number of the person with responsibility for the health and safety of persons at the mine. This person is generally the safety director or mine operator.
	<b>F.</b>	List the name, address, and telephone number of the person responsible for the business operation of the mine.
	<b>G.</b>	Provide the Federal taxpayer identification number for the applicant. For individuals, the social security number needs to be supplied as the tax identification number. The DMM cannot refund monies without the tax identification number.
	<b>H.</b>	Provide the name, address, and telephone number of all individuals having an ownership interest in the organization.
	<b>I.</b>	Provide any alias or assumed company or trade names, address, and telephone numbers that will be used by sole proprietors or partnerships.
	<b>J.</b>	Provide the names, titles, addresses, and telephone numbers of the principal organizational officials. The list should include all officers, directors, and members of the organization.
	<b>K.</b>	If the applicant name provided in Item 1 is not the true name of the corporation, then the true corporate name, address, and telephone number as recorded with the State Corporation Commission must be provided here.
	<b>L.</b>	List the state where the Article of Incorporation is filed. The Corporation must also be registered with the Virginia State Corporation Commission to do business in Virginia.
	<b>M.</b>	Provide the name, address, and telephone number for the registered agent for the corporation. This person is normally an attorney who insures that the corporate records, registration, and reports are maintained and filed properly.
	<b>N.</b>	If the applicant is a subsidiary of a larger company or corporation, the name, address, telephone number, and state of incorporation of the parent company must be provided.

6.		Provide the name, address, and telephone number of the person or persons designated by the operator to sign Permit/License documents. These documents include permit amendments, renewals, tonnage reports, etc. In addition to this person or persons, the applicant or any other corporate officers would be acceptable to sign Permit/License documents if they are listed elsewhere in the application.
7.		If any of the persons or companies listed in this application have owned all or part of a mining operation on which the Permit was revoked, the revocation must be acknowledged and explained in this section. The explanation should include the company names, permit numbers, issuing agencies, dates of revocation, names, addresses, and telephone numbers of the forfeiting company owners, corporate officers, and directors.
8.		Persons convicted of smoking in underground coal mines, possessing smoking materials in underground coal mines, or tampering with or disabling methane detection equipment in underground coal mines may be ineligible for a mine license or may have an existing license revoked. This information must be provided.
9.		<p>Complete Either A or B</p> <p>A.) Provide the requested information for any MSHA Identification numbers issued to the applicant, any members of the organization or any person owning 20 percent or more of the company, corporation or organization. This list must include all MSHA identification numbers. This should be a nationwide listing. MSHA identification numbers must be updated yearly at license renewal.</p> <p>B.) List all names under which the applicant and either members of the applicant or any person having 20 percent or greater ownership interest in the applicant operates a mine which has been issued a MSHA Federal Identification Number.</p>
<b>Only Transfer Applicants Need To Complete #10, #11, &amp; #12</b>		
10.		List any mining permits of any type held by the applicant in Virginia.
11.		List the name and address for the owner of the surface property to be covered by the permit. If the surface and mineral estates have been severed, please list the name and address of the mineral owner. If the mineral has not been severed, please indicate that the surface and mineral owner are the same.
12.		Provide a description of the deed, lease or agreement that grants the applicant the right to enter and mine on the property. This can be accomplished by providing the parties to the deed, lease or agreement, the date of execution and the county or city recording information for the document. Royalty rates or sale prices may be blacked out on any copies submitted for this purpose.
<b>Signature</b>		The person signing the License Renewal/Transfer Application should be an owner, corporate officer, or another previously designated person.
		Complete the certification statement by printing or typing the name of the person signing the form on the first line then have that person sign and date the form.

**Figure 3-7: Form DMM-157**

**COMMONWEALTH OF VIRGINIA  
DEPARTMENT OF MINES, MINERALS & ENERGY  
DIVISION OF MINERAL MINING  
900 Natural Resources Drive, Ste. 400  
Charlottesville, Virginia 22903  
(434) 951-6310**

**LICENSE RENEWAL/TRANSFER APPLICATION**

Application Tracking # \_\_\_\_\_

RENEWAL   
TRANSFER

**FOR OFFICE USE ONLY**

PERMIT # \_\_\_\_\_  
RECEIPT # \_\_\_\_\_  
DATE ISSUED \_\_\_\_\_

Permit No. (Renewals only) \_\_\_\_\_

1. Name of Applicant \_\_\_\_\_
2. Mailing Address \_\_\_\_\_
3. Office Telephone No. \_\_\_\_\_
4. Attach to this License Renewal/Transfer Application the following information on any contractors who will be working on the mine site in the next 12 months: trade name, business address, business telephone number, MSHA identification number (if applicable), address of record (if different than business address), service to be provided, where at the mine the work will be provided, person(s) with responsibility for operating decisions (name and address) and person(s) with responsibility for health and safety of employees (name and address). During the year any contractors on the mine site but not on the list must be reported individually. Contractors not shown on the attached list will no longer be associated with the mine permit.

PLEASE COMPLETE ANY INFORMATION THAT HAS CHANGED SINCE YOUR ORIGINAL LICENSE APPLICATION OR SINCE YOUR LAST RENEWAL. IF THE FORM IS BEING USED TO TRANSFER THE PERMIT, THEN ALL APPROPRIATE INFORMATION MUST BE PROVIDED.  
(be sure to complete the certification statement on page 3, sign and date the form)

**5. Type of Organization:**

- ( ) Sole Proprietorship - Complete questions A,B,C,D,E,F,G,I
- ( ) Corporation - Complete questions A,B,C,D,E,F,G,J,K,L,M,N
- ( ) Partnership - Complete questions A,B,C,D,E,F,G,H,I
- ( ) Other - Complete questions A,B,C,D,E,F,G,H,J

**Specify:**

- (A) Mine name, address and telephone number: \_\_\_\_\_  
\_\_\_\_\_
- (B) MSHA ID number of the mine (if applicable): \_\_\_\_\_
- (C) Person with overall responsibility for operating decisions at the mine  
Name/Title \_\_\_\_\_ Telephone # \_\_\_\_\_  
Address \_\_\_\_\_
- (D) Person to be contacted in the event of an accident or emergency  
Name \_\_\_\_\_ Telephone # \_\_\_\_\_  
Address \_\_\_\_\_
- (E) Person with overall responsibility for health and safety at the mine  
Name \_\_\_\_\_ Telephone # \_\_\_\_\_  
Address \_\_\_\_\_
- (F) Person responsible for business operation of the mine  
Name \_\_\_\_\_ Telephone # \_\_\_\_\_  
Address \_\_\_\_\_
- (G) Applicant's Federal Tax ID Number \_\_\_\_\_

**(H) List all individuals having any ownership interest in the organization**

Name/Title \_\_\_\_\_ Telephone # \_\_\_\_\_

Address \_\_\_\_\_

**(I) Trade name, address and telephone number for sole proprietors/partnerships**

\_\_\_\_\_

**(J) Principal organization officials, corporate officers, directors and members**

Name/Title \_\_\_\_\_ Telephone # \_\_\_\_\_

Address \_\_\_\_\_

**(K) Corporation name, address and telephone number if different than applicant**

\_\_\_\_\_

**(L) State of Incorporation \_\_\_\_\_**

**(M) Registered Agent \_\_\_\_\_ Telephone # \_\_\_\_\_**

Address \_\_\_\_\_

**(N) If a subsidiary, provide:**

Parent Organization Name \_\_\_\_\_

Address \_\_\_\_\_

Telephone No. \_\_\_\_\_ State of Incorporation \_\_\_\_\_

**6. Name, address and telephone number of person(s) authorized to sign Permit/License Documents.**

Name	Address	Telephone #
_____	_____	_____
_____	_____	_____
_____	_____	_____

**7. Have any of the above listed (1) persons, or (2) companies owned, in whole or in part, by said persons, the applicant, members of the organization, or any person having 20% or greater ownership interest had a mining permit issued by Virginia or any other state revoked? ( ) Yes ( ) No**

If yes, give a brief statement of action. \_\_\_\_\_

**8. Have any of the persons listed above been convicted of violating any of the following sections: 45.1-161.292:33, 45.1-161.177, 45.1-161.178, and 45.1-161.233 as related to smoking in underground coal mines or tampering with methane detection equipment in underground coal mines? ( ) Yes ( ) No**

If yes, give a brief statement of action. \_\_\_\_\_

**9. COMPLETE EITHER (A) OR (B)**

**(A) List all MSHA Federal Identification Numbers issued to the applicant, members of the organization, or any person having 20% or greater ownership interest in the organization.**

Identification No.	Status
_____	_____
_____	_____
_____	_____

- (B) List all names under which the applicant and either members of the applicant or any person having 20% or greater interest in the applicant operates a mine which has been issued a MSHA Federal Identification Number.

---

---

**ONLY TRANSFER APPLICANTS NEED TO COMPLETE #10, #11 AND #12**

10. List any mining permits of any type held by the applicant in Virginia and the applicable permit identification numbers.

Issuing Authority	Permit No./Identification No.
_____	_____
_____	_____
_____	_____

11. List any person with an ownership or leasehold interest in the surface land or minerals to be mined.

Name	Address
Surface _____	_____
Surface _____	_____
Mineral _____	_____
Mineral _____	_____

12. Specify source of applicant's legal right to enter and conduct mining operations on land covered by the permit: \_\_\_\_\_

Provide deed book number, page number, parties to the deed or lease, date of execution or provide copy of deed or lease.

I, \_\_\_\_\_, hereby certify that to the best of my knowledge, the  
(Print Name)  
information provided in this License Renewal/Transfer Application is accurate and complete.

\_\_\_\_\_  
Operating Official  
Signature

\_\_\_\_\_  
Date

### 3.7 PERMIT/LICENSE APPLICATION —FORM DMM-101

Anyone planning to operate a commercial mineral mine in Virginia must first apply for and receive a mining permit/license. Application for a permit/license requires the submittal of various forms, plans, and maps. These forms are generally provided to the prospective Mine Operator in a permit application package, which can be obtained from the area Mine Inspector or the Division of Mineral Mining Office in Charlottesville. The Permit/License Application is one of the required forms. It provides necessary information on the operator, the company structure, ownership, and some general operating parameters. Detailed operating plans must be submitted with the Permit/License Application form. Table 3-8 provides line-by-line instructions for completing form DMM-101. Figure 3-8 provides a copy of form DMM-101.

**Table 3-8: Form DMM-101 Instructions**

OWNERSHIP INFORMATION		
<b>1.</b>		Provide the name of the person, company, corporation, or other entity applying for the permit/license.
<b>2.</b>		Provide a telephone number for the company, person, or corporation where the operating officials can be contacted.
<b>3.</b>		Provide the mailing address for the person, company, corporation, or entity applying for the permit/license. All mail from the DMM will be sent to this address unless another name and address is specifically provided to receive such mail in the application.
		Provide the location of the mine. For example: "Mine is located three <u>miles North</u> of <u>Somewhere</u> on Public Road No. <u>999</u> in <u>Blank</u> County."
<b>4.</b>		Provide the type of organization that is applying for the Permit/License and answer only those questions in A through N that apply to the particular application type checked.
	<b>A.</b>	If you want the mine to be identified by a specific name or number please list the name or number here and give the mailing address of the mine if different than the address provided in number three.
	<b>B.</b>	Provide the Mine Safety and Health Administration (MSHA) identification number for the mine. All mines may not require a MSHA identification number. New mines cannot obtain an MSHA identification number until construction is initiated. The response here needs to indicate that either a MSHA identification number is not needed or that the number will be obtained and provided as a condition of the permit.
	<b>C.</b>	Provide the name, title, address, and phone number of the person responsible for operating decisions for the mine. This person is normally considered the mine operator and makes major decisions involving the mine's operation.
	<b>D.</b>	List the name, address, and telephone number of the person to be contacted in the event of an accident or emergency.
	<b>E.</b>	List the name, address, and telephone number of the person with responsibility for health and safety of persons at the mine. This person is generally the safety director or mine operator.



	<b>F.</b>	List the name, address, and telephone number of the person responsible for the business operation of the mine. This person is normally a controller, financial manager, or accounting person.
	<b>G.</b>	Provide the Federal taxpayer identification number for the applicant. For individuals, the social security number needs to be supplied as the tax identification number. The Division of Mineral Mining cannot refund monies without the tax identification number.
	<b>H.</b>	Provide the name, address, and telephone number of all individuals having an ownership interest in the organization.
	<b>I.</b>	Provide any alias or assumed company or trade names, address, and telephone numbers that will be used by sole proprietors or partnerships.
	<b>J.</b>	Provide the names, titles, addresses, and telephone numbers of the principal organizational officials. The list should include all officers, directors, and members of the organization.
	<b>K.</b>	If the applicant name provided in Item 1 is not the true name of the corporation, then the true corporate name, address, and telephone number as recorded with the State Corporation Commission must be provided here.
	<b>L.</b>	List the state where the Article of Incorporation is filed. The Corporation must also be registered with the Virginia State Corporation Commission to do business in Virginia.
	<b>M.</b>	Provide the name, address, and telephone number for the registered agent for the corporation. This person is normally an attorney who insures that the corporate records, registration, and reports are maintained and filed properly.
	<b>N.</b>	If the applicant is a subsidiary of a larger company or corporation, the name, address, telephone number, and state of incorporation of the parent company must be provided.
<b>5.</b>		Provide the name, address, and telephone number of the person or persons designated by the operator to sign permit/license documents. These documents would include permit amendments, renewals, tonnage reports, etc. In addition to this person or persons, the applicant, or any other corporate officers would also be considered acceptable to sign permit/license documents if they are listed elsewhere in the application.
<b>6.</b>		If any of the persons or companies listed in this application have owned all or part of a mining operation on which the mining permit was revoked, the revocation must be acknowledged and explained in this section. The explanation should include the company names, permit numbers, issuing agencies, dates of revocation, names, addresses, and telephone numbers of the forfeiting company owners, corporate officers, and directors.
<b>7.</b>		Persons convicted of smoking in underground coal mines, possessing smoking materials in underground coal mines, or tampering with or disabling methane detection equipment in underground coal mines may be ineligible for a mine license or may have an existing license revoked. This information must be provided.
<b>OPERATIONS INFORMATION</b>		
<b>8.</b>		The latitude and longitude coordinates of the operation must be listed. The engineer or surveyor should be able to provide the information to the applicant or the Mine Inspector may help.
<b>9.</b>		List the mineral to be mined and the estimated annual production.

10.		Check the type of mine to be operated. Open-pit mines are generally surface mines where the mineral is excavated without blasting; quarries are generally hard rock mines where blasting is required to excavate the mineral; underground mines extend underneath the earth's surface in tunnels and drifts; dredge and dragline generally refer to excavation of material from a natural water body; dredges are generally floating hydraulic dredges and draglines generally work from the bank or from a floating barge.
11.		Complete Either A or B A.) Provide the requested information for any Mine Safety and Health Administration (MSHA) Identification numbers issued to the applicant, any members of the organization or any person owning 20 percent or more of the company, corporation or organization. This should be a nationwide listing. B.) List all names under which the applicant and either members of the applicant or any person having 20 percent or greater ownership interest in the applicant operates a mine which has been issued a MSHA Federal Identification Number.
12.		List any mining permits of any type held by the applicant in Virginia.
13.		Indicate whether or not explosives will be used to mine the mineral.
14.		List the number of employees to be utilized on each shift. If work will only be performed on one shift, put 0 for shift two and three.
15.		This distance is a straight line from the mine area to the nearest inhabited building. This distance can usually be scaled from a standard topographic map or a scaled aerial photograph.
16.		The Division of Mineral Mining offers training services to miners and mine operators. This question allows us to evaluate the need for our services.
17.		List the name and address for the owner of the surface property to be covered by the permit. If the surface and mineral estates have been severed, please list the name and address of the mineral owner. If the mineral has not been severed, please indicate that the surface and mineral owner are the same.
18.		Provide a description of the deed, lease, or agreement that grants the applicant the right to enter and mine on the property. This can be accomplished by providing a copy of the deed, lease, or agreement or by providing the parties to the deed, lease, or agreement, the date of execution and the county or city recording information for the document. Royalty rates or sale prices may be blacked out on any copies submitted for this purpose.
19.		Provide the names, addresses, and telephone numbers of any independent contractors that will be performing work on the mine site. For each contractor, also provide the name of the contact person and the type of work the contractor will perform on the mine site. An independent contractor generally provides supervision for its own workers and is responsible to the mine operator for the final outcome of the work. Only independent contractors need to be reported in this section.
20.		Provide the names of any rivers, streams, lakes, or other water bodies located on or adjacent to the permit boundary; especially any that will receive runoff water from the mine site. Also provide the name of the first river, stream, lake, or other water body that these waterways flow into. For all waters on or adjacent to the permit boundary please provide the pH of the water upstream and downstream from the mine site. An engineer, environmental consultant, or the site Mine Inspector may be of assistance in measuring the pH.
21.		In this section provide a brief description of the drainage control techniques to be employed at the mine.

		For example: "three sediment basins and two sediment traps will be constructed to provide sediment control. Stabilized ditches, berms, and road culverts will be used to direct run off to the sediment structures. See the enclosed erosion control plan, narrative, erosion control structure designs, and drainage maps enclosed for more information." A detailed Drainage Control Plan must accompany the Permit/License Application.
22.		Provide a listing of any chemicals (including petroleum products) to be used in the mining or processing operation and the methods used to contain these chemicals and prevent environmental contamination. The listing should include any processing chemicals (i.e., acids, bases, flocculants, etc.) and methods of storage (i.e., surface or underground tanks and associated containment).
23.		Briefly describe disposal and handling for the listed materials. Provide, where necessary, more detailed designs and handling plans as attachments. Some examples of responses are: <u>Overburden</u> —placed in designated spoil area or used to construct screening berms; <u>Spoil/Waste Minerals</u> —placed in designated spoil area or refuse fill; <u>Scrap Metal</u> —stored in one area and periodically recycled; <u>Scrap Tires</u> —hailed to county landfill; <u>Used Oil</u> —stored in closed containers and periodically recycled; <u>Trash And Debris</u> —hailed to county landfill; <u>Hazardous Materials</u> —any encountered will be disposed of in accordance with the MSDS; <u>Buildings and Structures</u> —will be removed upon completion of operations.
<b>OPERATION/RECLAMATION PLANS</b>		
24.		Attach narratives, plans, and designs to fully address all phases of the operation reclamation and drainage controls for the site as outlined in the Permit Application Checklist.
<b>PLANS: OPERATION/RECLAMATION/DRAINAGE PLAN</b>		
<b>Signature</b>		The person signing this form must be an owner or corporate officer as listed in item 4 of this form.
		The signature area serves as a certification that the form is complete and accurate. The person who will sign the form should print or type their name on the first line of the certification statement then sign and write their title on the name and title line.

### Figure 3-8 Form DMM 101

**COMMONWEALTH OF VIRGINIA  
DEPARTMENT OF MINES, MINERALS & ENERGY  
DIVISION OF MINERAL MINING  
900 NATURAL RESOURCES DRIVE, STE. 400  
CHARLOTTESVILLE, VIRGINIA 22903  
(434) 951-6310**

**PERMIT/LICENSE APPLICATION**

**FOR OFFICE USE ONLY**

APPLICATION TRACKING # \_\_\_\_\_

PERMIT NO. \_\_\_\_\_

RECEIPT NO. \_\_\_\_\_

DATE ISSUED: \_\_\_\_\_

**OWNERSHIP INFORMATION**

1. Name of Applicant \_\_\_\_\_

2. Office Telephone Number \_\_\_\_\_

3. Mailing Address \_\_\_\_\_

Mine is located \_\_\_\_\_ of \_\_\_\_\_  
(miles) (direction) (town)

on Public Road No. \_\_\_\_\_ in \_\_\_\_\_ County/City

4. Type of Organization:

- ( ) Sole Proprietorship - Complete questions A,B,C,D,E,F,G,I
- ( ) Corporation - Complete questions A,B,C,D,E,F,G,J,K,L,M,N
- ( ) Partnership - Complete questions A,B,C,D,E,F,G,H,I
- ( ) Other - Complete questions A,B,C,D,E,F,G,H,J

Specify: \_\_\_\_\_

(A) Name, address and telephone number of the Mine \_\_\_\_\_

(B) MSHA ID number of the Mine (if applicable) \_\_\_\_\_

(C) Person with overall responsibility for operating decisions at the mine:

Name/Title \_\_\_\_\_  
Address \_\_\_\_\_  
Phone \_\_\_\_\_

(D) Person to be contacted in the event of an accident or emergency:

Name	Address	Telephone
_____	_____	_____

(E) Person with overall responsibility for health and safety at the mine:

Name	Address	Telephone
_____	_____	_____

(F) Person responsible for business operation of the mine:

Name	Address	Telephone
_____	_____	_____

(G) Federal Tax ID Number of Applicant \_\_\_\_\_

(H) List all individuals having any ownership interest in the organization.  
Name/Title Address Telephone

---

---

(I) Trade name, address and telephone number for sole proprietors/partnerships:  
\_\_\_\_\_  
\_\_\_\_\_

(J) Principal organization officials, corporate officers, directors and members:  
Name/Title Address Telephone

---

---

(K) Corporation name, address and telephone number if different than applicant:  
\_\_\_\_\_

(L) State of Incorporation \_\_\_\_\_

(M) Registered Agent:  
Name Address Telephone

---

(N) If a subsidiary, provide:  
Parent Organization Name: \_\_\_\_\_  
Address \_\_\_\_\_  
Telephone \_\_\_\_\_ State of Incorporation \_\_\_\_\_

5. Name, address and telephone number of person(s) authorized to sign permit/license documents:  
Name Address Telephone

---

---

---

---

6. (A) Have any of the above listed (1) persons, or (2) companies owned, in whole or in part, by said persons, the applicant, members of the organization, or any person having 20% or greater ownership interest in the organization had a mining permit issued by Virginia or any other state revoked? ( ) Yes ( ) No

(b) If yes, give a brief statement of action.  
\_\_\_\_\_  
\_\_\_\_\_

7. Have any of the persons listed above been convicted of violating any of the following sections: 45.1-161.292:33, 45.1-161.177, 45.1-161.178, and 45.1-161.233 as related to smoking in underground coal mines or tampering with methane detection equipment in underground coal mines?  
( ) Yes ( ) No  
If yes, give name of person convicted \_\_\_\_\_

**OPERATIONS INFORMATION**

8. Latitude \_\_\_\_\_ Longitude \_\_\_\_\_  
9. Mineral to be mined \_\_\_\_\_ Estimated annual production (in tons) \_\_\_\_\_  
10. Type of Mine: ( ) Open Pit ( ) Quarry ( ) Underground ( ) Dredge  
( ) Dragline ( ) Other (specify) \_\_\_\_\_

11. COMPLETE EITHER A OR B

- (A). List all MSHA Federal Identification Numbers issued to the applicant, members of the organization, or any person having 20% or greater ownership interest in the organization.

Identification No.	Status
_____	_____
_____	_____
_____	_____

- (B). List all names under which the applicant and either members of the applicant or any person having 20% or greater ownership interest in the applicant operates a mine which has been issued a MSHA Federal Identification Number.

\_\_\_\_\_  
\_\_\_\_\_

12. List any mining permits of any type held by the applicant in Virginia and the applicable permit identification numbers.

Issuing Authority	Permit No./Identification No.
_____	_____
_____	_____
_____	_____

13. Will explosive storage and blasting be required? ( ) Yes ( ) No  
14. Number of employees each shift 1<sup>st</sup> \_\_\_\_\_ 2<sup>nd</sup> \_\_\_\_\_ 3<sup>rd</sup> \_\_\_\_\_  
15. Distance in feet to nearest inhabited building \_\_\_\_\_  
16. Does the applicant have the personnel and facilities to provide safety training to its employees?  
( ) Yes ( ) No

17. List any person with an ownership or leasehold interest in the surface land or minerals to be mined.

NAME	ADDRESS
Surface _____	_____
Surface _____	_____
Mineral _____	_____
Mineral _____	_____

18. Specify source of applicant's legal right to enter and conduct mining operations on land covered by the permit:

\_\_\_\_\_  
 Provide deed book number, page number, parties to the deed or lease, date of execution or provide a copy of the deed or lease.

19. Please provide the following information for any contractors who will be working on the mine site (attach additional sheets as necessary).

Contractor's Trade Name \_\_\_\_\_ DMM # \_\_\_\_\_  
 Business Address \_\_\_\_\_  
 Business Telephone \_\_\_\_\_ MSHA ID # (if available) \_\_\_\_\_  
 Address of Record \_\_\_\_\_  
 Service to be Provided \_\_\_\_\_  
 Where at the Mine Will the Work be Provided \_\_\_\_\_

Persons with responsibility for operating decisions:

Name	Address
_____	_____
_____	_____

Persons with responsibility for the health and safety of employees:

Name	Address
_____	_____
_____	_____

20. List rivers, streams, tributaries or water impoundments on or adjacent to permitted property.

Name of waterway	pH adjacent to the mine	Tributary to
_____	_____	_____
_____	_____	_____

21. Specify how mine discharge and storm runoff water will be handled to minimize impact on any water courses. (Detail drainage plan attached). \_\_\_\_\_

\_\_\_\_\_

22. Specify any chemicals or hazardous materials (including petroleum products) which will be used on the mine site and methods to be employed to prevent contamination of land and water resources on or adjoining permitted property.

---

---

---

**OPERATION/RECLAMATION PLANS**

23. Specify the materials which will be generated by mining operations and the plans for handling and disposal during operations and reclamation.

TYPE OF MATERIAL	DISPOSAL METHOD
Overburden	_____
Spoil/Waste Minerals	_____
Scrap Metal	_____
Scrap Tires	_____
Used Oil and Lubricants	_____
Trash and Debris	_____
Hazardous Material	_____
Buildings/Structures	_____

**PLANS: OPERATION/RECLAMATION/DRAINAGE PLAN**

24. Describe in detail the method of mining, procedures for handling drainage, regrading, and vegetation during active mining and upon completion (attach narrative).

**CERTIFICATION/SIGNATURE**

I, \_\_\_\_\_, state that all the presentations contained in the foregoing  
(Print Name)  
application are true to the best of my knowledge; and that I am (an executive officer), (a general partner), (the sole proprietor), (a legal representative), of the applicant, duly authorized to make this application on its behalf. On behalf of the applicant, I hereby authorize the Virginia Division of Mineral Mining to conduct such safety/reclamation inspections as it may deem necessary or as may be required by law on this mining operation.

\_\_\_\_\_  
Signature Title

subscribed and sworn to, this \_\_\_\_\_ day of \_\_\_\_\_, \_\_\_\_\_.  
(Month) (Year)



### 3.8 MINERAL MINING MAP LEGEND—FORM DMM-109

Maps submitted to the Division must be accompanied by a corresponding map legend that identifies the origin of the map, any appropriate color-coding and associated acreages, information regarding the person preparing the map, and signature of the person preparing the map. Table 3-9 provides line-by-line instructions for completing form DMM-109. Figure 3-9 provides a copy of form DMM-109.

**Table 3-9: Form DMM-109 Instructions**

<b>Type of Map</b>	Check the appropriate map type representing the nature of the map.
<b>Permit Number</b>	Provide the five-digit and two-letter permit number that was assigned when the current permit was issued. Maps accompanying new permit applications need not fill in this blank.
<b>County</b>	Enter the county in which the mine is located. If the mine lies in more than one county enter all counties in which it is located.
<b>Company Name</b>	Enter the name as it appears on the Permit/License Application.
<b>Map Scale</b>	Enter the scale of the map "one inch" equal to "X" number of feet. The scale should not be less than 1" = 400' for a permit map.
<b>USGS Quadrangle</b>	Indicate in which United States Geological Survey Quadrangle the permit lies, if known.
<b>Color Code</b>	Specific color codes must be used on the mine maps to identify different stages of mine development and reclamation. Each specific area on the mine map must correspond to an acreage calculation provided on the map legend.
	"Outline Red" indicates the total area within the approved permit.
	"Solid Yellow" indicates the total area that is disturbed within the permitted area. Note: this also includes all access roads permitted to the mine.
	"Solid Brown" indicates the area that will be disturbed within the next 12 months. This code is used at renewal and at other times when additional permitted acreage is being bonding for mining.
	"Cross-Hatch Green" indicates that the area is suitable for bond release as determined by the DMM mine inspector.
	"Solid Green" indicates that the area has been revegetated within the past 12 months
	"Cross-Hatched Red" indicates that the area is being deleted from the current permitted area.
	"Cross-Hatched Black" indicates permitted areas where bond release has previously been approved.
	"Cross-Hatched Purple" indicates the area of the permit which has been relinquished to another permit.
	"Solid Blue" indicates drainage patterns and bodies of water within the permitted and bonded area.

<b>Map Prepared By</b>	Name of the person who prepared the map. Please print name legibly.
<b>Registration No.</b>	If prepared by a Licensed Surveyor or Professional Engineer, their registration numbers must be provided in the appropriate blanks.
<b>Signature</b>	Signature of the person preparing the map.
<b>Date</b>	Date that the person preparing the map signed the legend.

**Figure 3-9: Form DMM-109**

**COMMONWEALTH OF VIRGINIA  
DEPARTMENT OF MINES, MINERALS & ENERGY  
DIVISION OF MINERAL MINING  
900 Natural Resources Drive, Ste. 400  
Charlottesville, Virginia 22903  
(434) 951-6310**

- |  |                                       |   |
|--|---------------------------------------|---|
| <input type="checkbox"/> Application Map                 | <input type="checkbox"/> Renewal Map  | <input type="checkbox"/> Amendment Map      |
| <input type="checkbox"/> Completion Map                  | <input type="checkbox"/> Bond Release | <input type="checkbox"/> Relinquishment Map |
| <input type="checkbox"/> Combined Safety/Reclamation Map |                                       |   |

**LEGEND**

Permit Number \_\_\_\_\_ County \_\_\_\_\_

Company Name \_\_\_\_\_

Map Scale 1"= \_\_\_\_\_ USGS Quadrangle \_\_\_\_\_

**COLOR CODE**

**Outline Red**                      No. of acres covered by this permit \_\_\_\_\_

**Yellow**                              No. of acres disturbed, including access roads \_\_\_\_\_

**Brown**                                No. of additional acres to be disturbed  
during the next 12 months \_\_\_\_\_

**Cross-Hatch Green**              No. of acres suitable for bond release (must be approved by  
Inspector) \_\_\_\_\_

**Green**                                No. of acres vegetated during the last 12 months \_\_\_\_\_

**Cross-Hatch Red**                No. of acres deleted from the permit \_\_\_\_\_

**Cross-Hatch Black**              No. of reclaimed acres with bond released previously \_\_\_\_\_

**Cross-Hatch Purple**            No. of acres relinquished \_\_\_\_\_

**Blue**                                 Water and drainage pattern

Map prepared by \_\_\_\_\_

L. S. Reg. No. \_\_\_\_\_ VA

P. E. Reg. No. \_\_\_\_\_ VA

**I, the undersigned, hereby certify this map is true and accurate, showing to the best of my knowledge and belief, all information required by Virginia Mineral Mining Law.**

\_\_\_\_\_  
**Signature**

\_\_\_\_\_  
**Date**

**DMM-109  
REV. 02/06**

On the following pages are a series of six sample map legends (form DMM-109) with accompanying maps for six different permit application scenarios. The forms and maps provide a fictional progression of a mining operation from application to completion. The following is a brief description of the six samples.

1. Permit application map covering 100.00 acres of which 45.00 acres will be disturbed in the next 12 months. (Figure 3-10 and Example #1 map)
2. First Annual renewal map. 100.00 acres still under permit. 45.00 acres have been disturbed, and 18.00 acres will be disturbed in the next 12 months. (Figure 3-11 and Example #2 map)
3. Second Annual renewal map. 100.00 acres still under permit. 49.00 acres have been disturbed, and an additional seven acres will be disturbed over the next 12 months. Also, 14.00 acres were revegetated in the last 12 months. (Figure 3-12 and Example #3 map)
4. Amendment map. 22.00 additional acres are being added to the mining permit for a new total of 122.00 acres, 56.00 acres are presently disturbed and five additional acres will be disturbed in the next 12 months. The 14.00 acres shown on the last renewal map (map #3) are still the only acreage revegetated and they are not ready for bond release. (Figure 3-13 and Example #4 map)
5. Third annual renewal map with partial bond release. A total of 122.00 acres are on the permit. 61.00 acres are presently disturbed. The 14.00 revegetated acres shown on maps #3 and #4 are now suitable for bond release. (Figure 3-14 and Example #5 map)
6. Completion Map. Mining activity on the permit area is completed. The permit still covers the 122.00 acres, however, there is no acreage presently disturbed, or proposed, for future disturbance. 61.00 acres have been revegetated over the last 12 months. The 14.00 acres where bond was previously released (note: map five) are shown crosshatch black. The completion map is the final map required by the Division. (Figure 3-15 and Example #6 map)

### Figure 3-10: Sample Initial Permit Application Map

COMMONWEALTH OF VIRGINIA  
DEPARTMENT OF MINES, MINERALS & ENERGY  
DIVISION OF MINERAL MINING  
900 Natural Resources Drive, Suite 400  
Charlottesville, Virginia 22903  
434-951-6310

- (X ) Application Map                      ( ) Renewal Map                      ( ) Amendment Map  
( ) Completion Map                      ( ) Bond Release                      ( ) Relinquishment Map  
( ) Combined Safety/Reclamation Map

#### LEGEND

Permit Number 01234AA County Anywhere  
Company Name ABC Mining Co.  
Map Scale 1" = 400' USGS Quadrangle Anyname

#### COLOR CODE

Outline Red	No. of acres covered by this permit <u>100.00</u>
Yellow	No. of acres disturbed, including access roads <u>                    </u>
Brown	No. of additional acres to be disturbed during the next 12 months <u>45.00</u>
Cross-Hatch Green	No. of acres suitable for bond release (must be approved by Inspector) <u>                    </u>
Green	No. of acres vegetated during the last 12 months <u>                    </u>
Cross-Hatch Red	No. of acres deleted from the permit <u>                    </u>
Cross-Hatch Black	No. of reclaimed acres with bond released previously <u>                    </u>
Cross-Hatch Purple	No. of acres relinquished <u>                    </u>
Blue	Water and drainage pattern

Map prepared by                     

L. S. Reg. No.                      VA      P. E. Reg. No.                      VA

I, the undersigned, hereby certify this map is true and accurate, showing to the best of my knowledge and belief, all information required by Virginia Mineral Mining Law.

                      
Signature

                      
Date

### Example #1 Map: Initial Permit Application Map

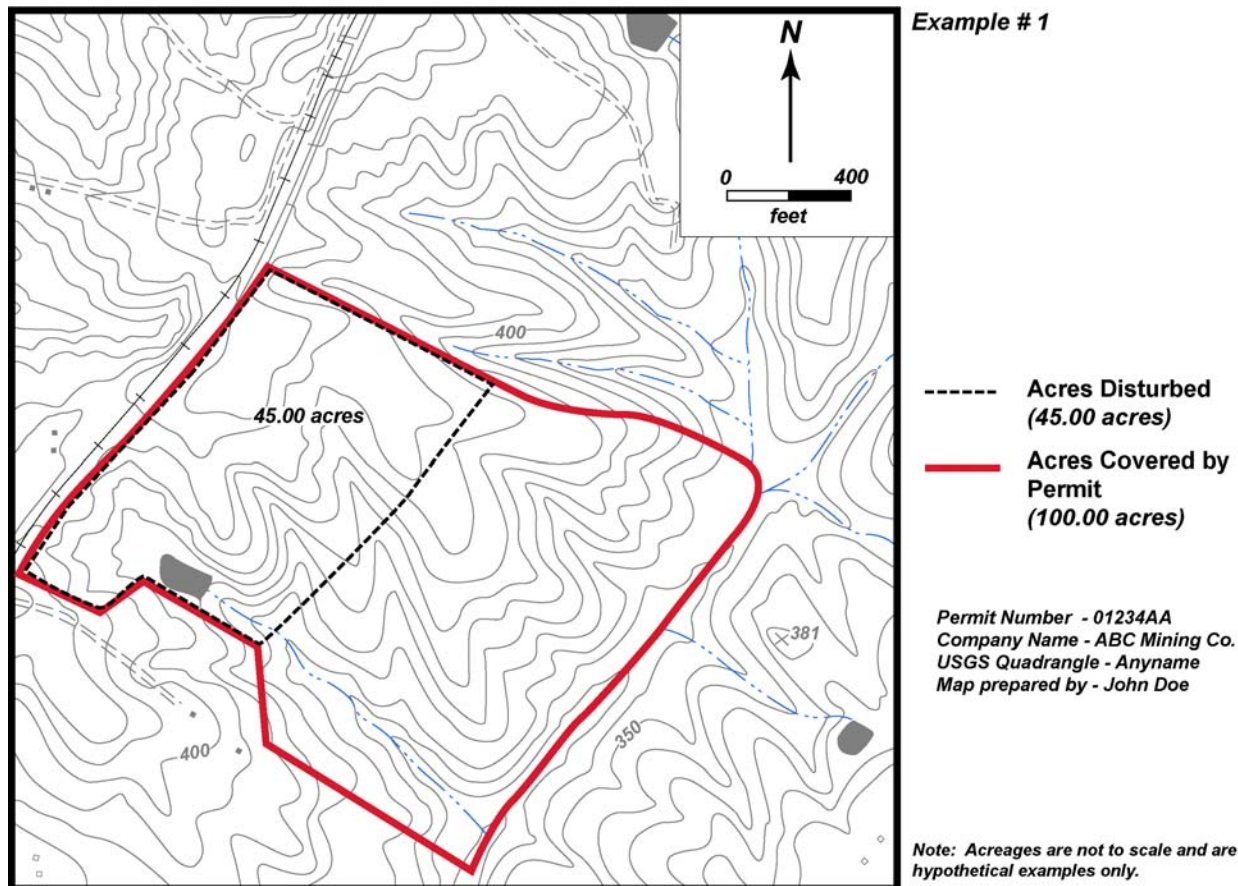

### Figure 3-11: Sample First Annual Renewal Map

COMMONWEALTH OF VIRGINIA  
DEPARTMENT OF MINES, MINERALS & ENERGY  
DIVISION OF MINERAL MINING  
900 Natural Resources Drive, Suite 400  
Charlottesville, Virginia 22903  
434-951-6310

- Application Map                       Renewal Map                       Amendment Map
- Completion Map                       Bond Release                       Relinquishment Map
- Combined Safety/Reclamation Map

**LEGEND**

Permit Number 01234AA County Anywhere  
 Company Name ABC Mining Co.  
 Map Scale 1" = 400' USGS Quadrangle Anyname

**COLOR CODE**

Outline Red	No. of acres covered by this permit <u>100.00</u>
Yellow	No. of acres disturbed, including access roads <u>45.00</u>
Brown	No. of additional acres to be disturbed during the next 12 months <u>18.00</u>
Cross-Hatch Green	No. of acres suitable for bond release (must be approved by Inspector) _____
Green	No. of acres vegetated during the last 12 months _____
Cross-Hatch Red	No. of acres deleted from the permit _____
Cross-Hatch Black	No. of reclaimed acres with bond released previously _____
Cross-Hatch Purple	No. of acres relinquished _____
Blue	Water and drainage pattern

Map prepared by \_\_\_\_\_

L. S. Reg. No. \_\_\_\_\_ VA    P. E. Reg. No. \_\_\_\_\_ VA

I, the undersigned, hereby certify this map is true and accurate, showing to the best of my knowledge and belief, all information required by Virginia Mineral Mining Law.

\_\_\_\_\_  
Signature

\_\_\_\_\_  
Date

DMM-109  
REV. 9/99

### Example #2 Map: First Annual Renewal Map

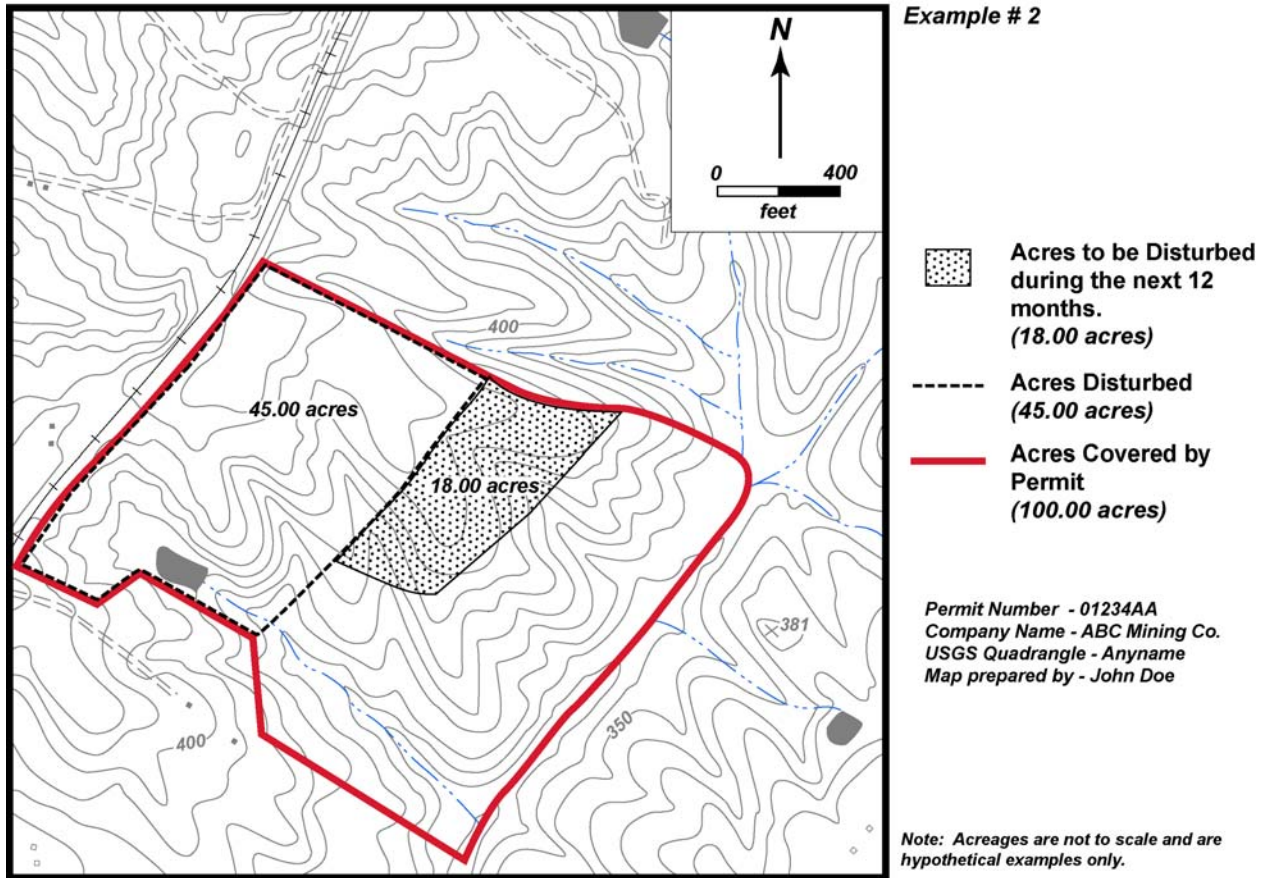



**Figure 3-12: Sample Second Annual Renewal Map**

**COMMONWEALTH OF VIRGINIA  
DEPARTMENT OF MINES, MINERALS & ENERGY  
DIVISION OF MINERAL MINING  
900 Natural Resources Drive, Suite 400  
Charlottesville, Virginia 22903  
434-951-6310**

- Application Map                       Renewal Map                       Amendment Map  
 Completion Map                       Bond Release                       Relinquishment Map  
 Combined Safety/Reclamation Map

**LEGEND**

Permit Number 01234AA County Anywhere  
Company Name ABC Mining Co.  
Map Scale 1" = 400' USGS Quadrangle Anyname

**COLOR CODE**

Outline Red	No. of acres covered by this permit <u>100.00</u>
Yellow	No. of acres disturbed, including access roads <u>49.00</u>
Brown	No. of additional acres to be disturbed during the next 12 months <u>7.00</u>
Cross-Hatch Green	No. of acres suitable for bond release (must be approved by Inspector) _____
Green	No. of acres vegetated during the last 12 months <u>14.00</u>
Cross-Hatch Red	No. of acres deleted from the permit _____
Cross-Hatch Black	No. of reclaimed acres with bond released previously _____
Cross-Hatch Purple	No. of acres relinquished _____
Blue	Water and drainage pattern

Map prepared by \_\_\_\_\_

L. S. Reg. No. \_\_\_\_\_ VA P. E. Reg. No. \_\_\_\_\_ VA

I, the undersigned, hereby certify this map is true and accurate, showing to the best of my knowledge and belief, all information required by Virginia Mineral Mining Law.

\_\_\_\_\_  
Signature



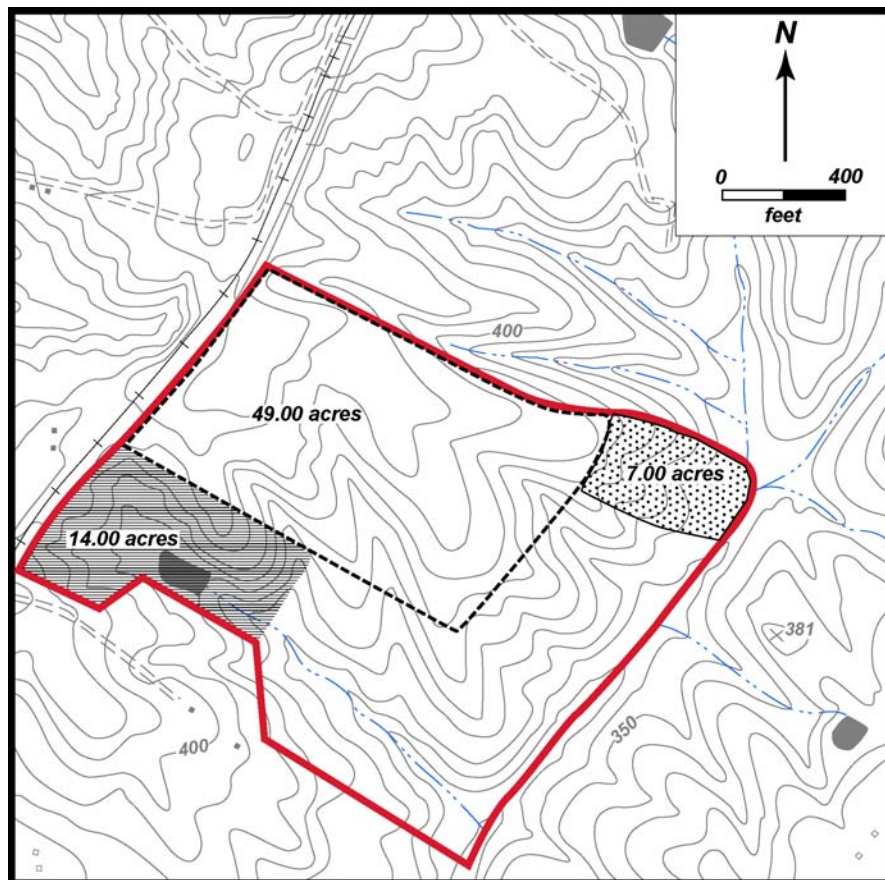

\_\_\_\_\_  
Date

DMM-109  
REV. 9/99

### Example #3 Map: Second Annual Renewal Map



Example # 3

-  Acres vegetated during the last 12 months. (14.00 acres)
-  Acres to be Disturbed during the next 12 months. (7.00 acres)
-  Acres Disturbed (49.00 acres)
-  Acres Covered by Permit (100.00 acres)

Permit Number - 01234AA  
Company Name - ABC Mining Co.  
USGS Quadrangle - Anyname  
Map prepared by - John Doe

Note: Acreages are not to scale and are hypothetical examples only.

### Figure 3-13: Sample Amendment Map

COMMONWEALTH OF VIRGINIA  
DEPARTMENT OF MINES, MINERALS & ENERGY  
DIVISION OF MINERAL MINING  
900 Natural Resources Drive, Suite 400  
Charlottesville, Virginia 22903  
434-951-6310

- Application Map                       Renewal Map                       Amendment Map  
 Completion Map                       Bond Release                       Relinquishment Map  
 Combined Safety/Reclamation Map

#### LEGEND

Permit Number 01234AA County Anywhere  
Company Name ABC Mining Co.  
Map Scale 1" = 400' USGS Quadrangle Anyname

#### COLOR CODE

Outline Red	No. of acres covered by this permit <u>100.00 + 22.00 = 122.00</u>
Yellow	No. of acres disturbed, including access roads <u>56.00</u>
Brown	No. of additional acres to be disturbed during the next 12 months <u>5.00</u>
Cross-Hatch Green	No. of acres suitable for bond release (must be approved by Inspector) _____
Green	No. of acres vegetated during the last 12 months <u>14.00</u>
Cross-Hatch Red	No. of acres deleted from the permit _____
Cross-Hatch Black	No. of reclaimed acres with bond released previously _____
Cross-Hatch Purple	No. of acres relinquished _____
Blue	Water and drainage pattern

Map prepared by \_\_\_\_\_

L. S. Reg. No. \_\_\_\_\_ VA      P. E. Reg. No. \_\_\_\_\_ VA

I, the undersigned, hereby certify this map is true and accurate, showing to the best of my knowledge and belief, all information required by Virginia Mineral Mining Law.

\_\_\_\_\_  
Signature

\_\_\_\_\_  
Date

DMM-109  
REV. 9/99

### Example #4 Map: Amendment Map

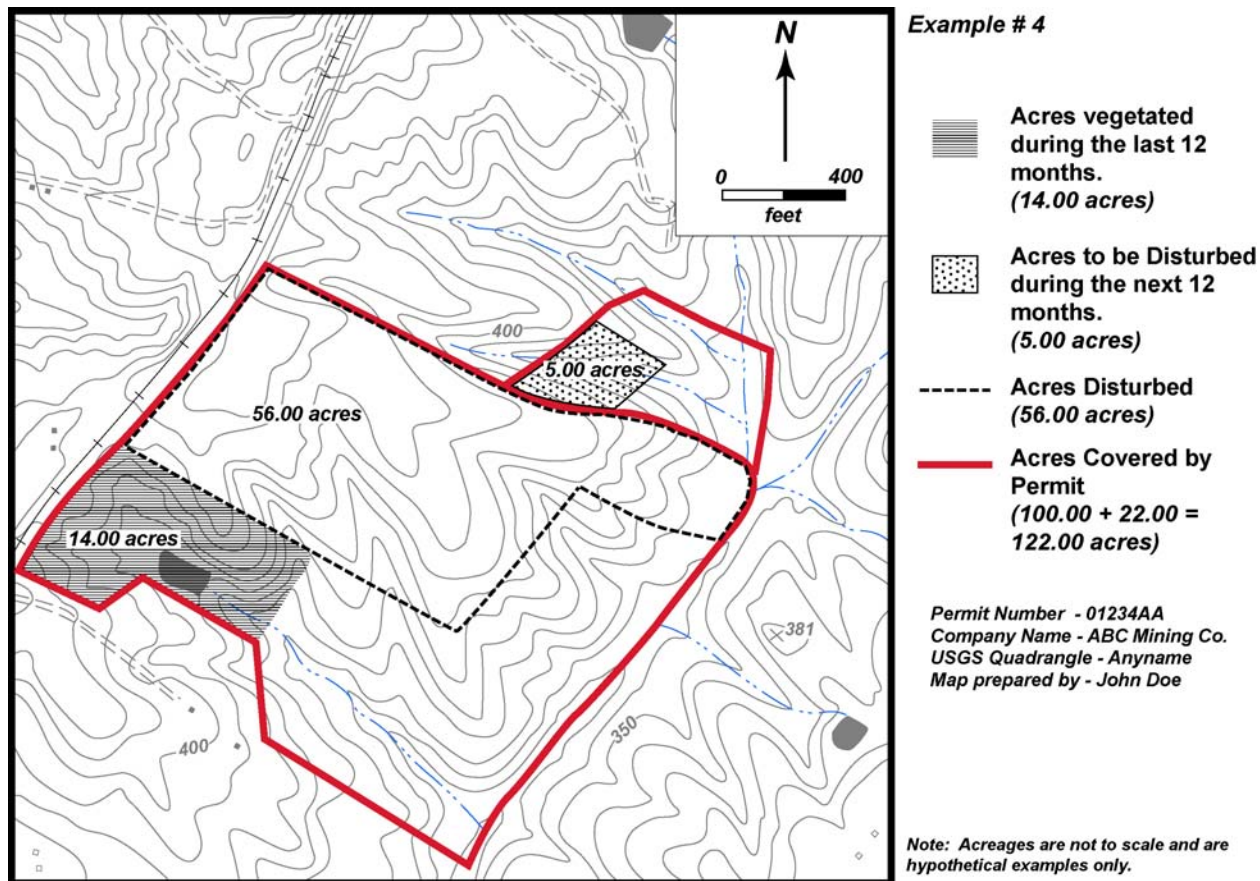



### Example #5 Map: Third Annual Renewal Map with Partial Bond Release

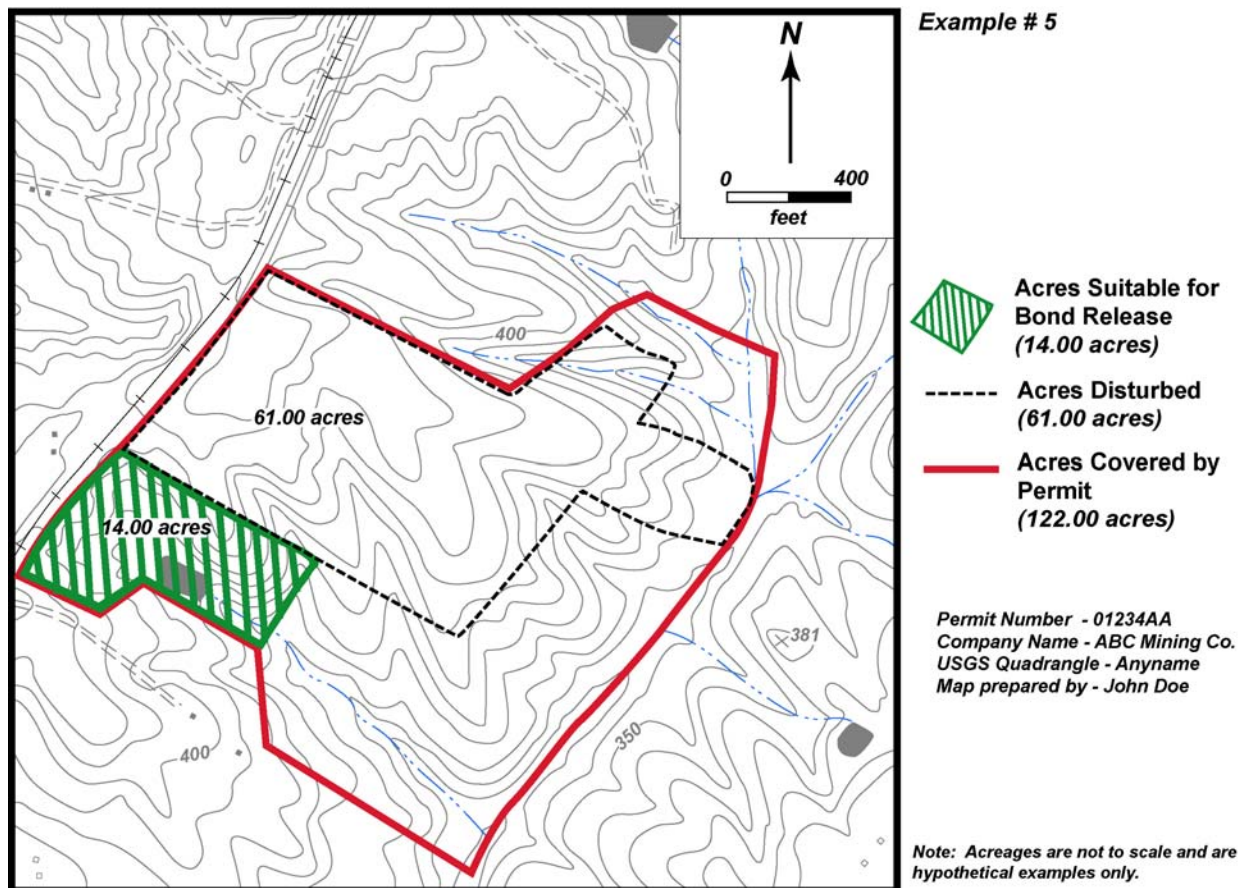

### Figure 3-15: Sample Completion Map

COMMONWEALTH OF VIRGINIA  
DEPARTMENT OF MINES, MINERALS & ENERGY  
DIVISION OF MINERAL MINING  
900 Natural Resources Drive, Suite 400  
Charlottesville, Virginia 22903  
434-951-6310

- Application Map
- Completion Map
- Combined Safety/Reclamation Map
- Renewal Map
- Bond Release
- Amendment Map
- Relinquishment Map

**LEGEND**

Permit Number 01234AA County Anywhere  
 Company Name ABC Mining Co.  
 Map Scale 1" = 400' USGS Quadrangle Anyname

**COLOR CODE**

Outline Red	No. of acres covered by this permit <u>122.00</u>
Yellow	No. of acres disturbed, including access roads _____
Brown	No. of additional acres to be disturbed during the next 12 months _____
Cross-Hatch Green	No. of acres suitable for bond release (must be approved by Inspector) _____
Green	No. of acres vegetated during the last 12 months <u>61.00</u>
Cross-Hatch Red	No. of acres deleted from the permit _____
Cross-Hatch Black	No. of reclaimed acres with bond released previously <u>14.00</u>
Cross-Hatch Purple	No. of acres relinquished _____
Blue	Water and drainage pattern

Map prepared by \_\_\_\_\_

L. S. Reg. No. \_\_\_\_\_ VA P. E. Reg. No. \_\_\_\_\_ VA

I, the undersigned, hereby certify this map is true and accurate, showing to the best of my knowledge and belief, all information required by Virginia Mineral Mining Law.

\_\_\_\_\_  
Signature

\_\_\_\_\_  
Date



### Example #6 Map: Completion Map

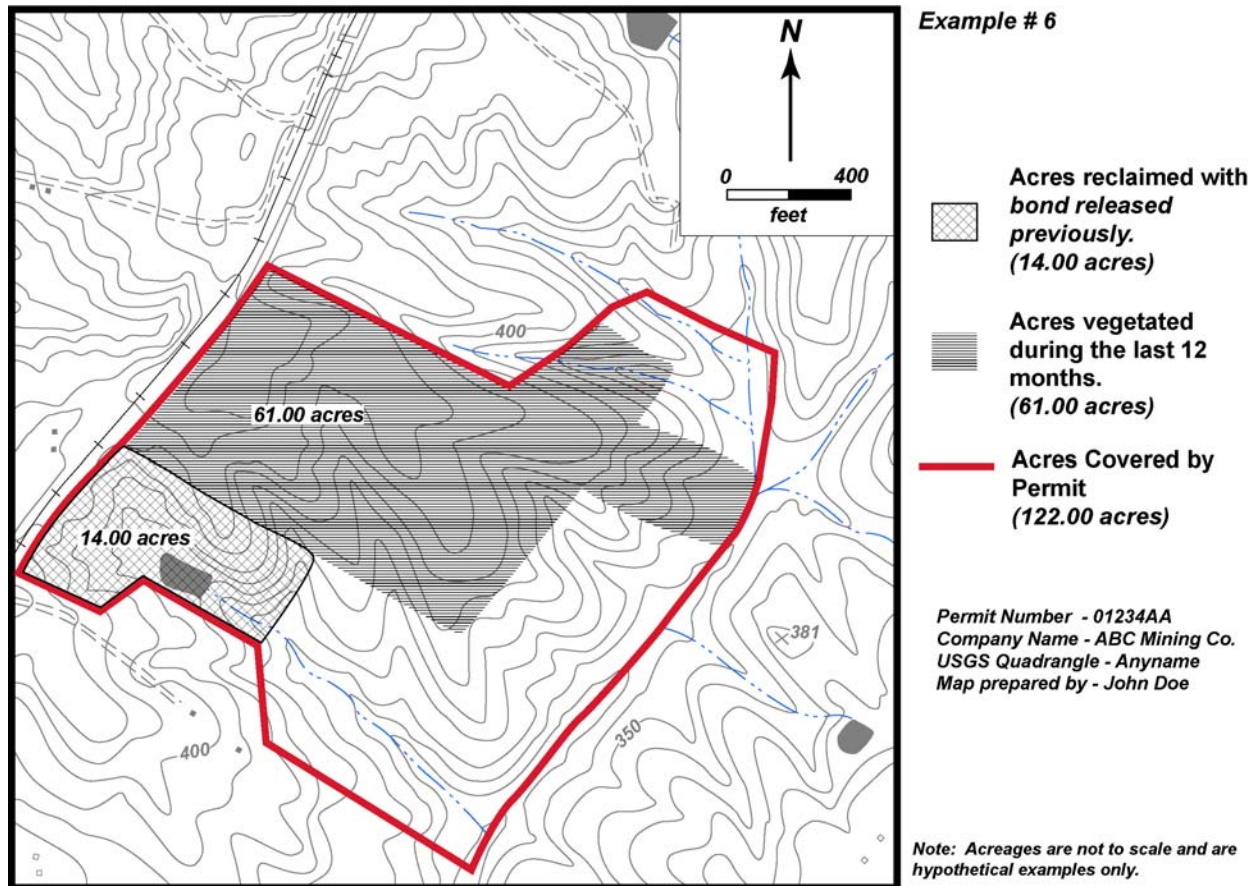



This page intentionally left blank.



## 4 OVERBURDEN AND SPOIL DISPOSAL AREAS

### 4.1 DEFINITION

Overburden and spoil may be disposed of in valleys (valley fills), on hillsides (side hill fills) or on flat terrain (mounded fills). These fills represent designated areas within the permit for either temporary or permanent disposal of overburden, process spoils, or dry tailings.

### 4.2 PURPOSE

To allow placement of overburden and process spoils in a controlled manner to ensure fill stability, prevent landslides, provide proper drainage and erosion control and provide for final reclamation of the disposal area.

### 4.3 CONDITIONS WHERE PRACTICE APPLIES

Fill designs depend on a variety of factors. These include site topography, the type of material to be placed in the fill, the desired post mining land use, the quantity of material to be disposed of, and the availability of suitable disposal areas. Mine operations plans should include plans for fill construction when considerable amounts of overburden, spoil, or other dry wastes will be generated and require disposal. Efforts should be made, where possible, to place fills in areas previously disturbed for mining purposes, such as old pits. In that way, fills may be incorporated into the active mining operation as a reclamation activity.

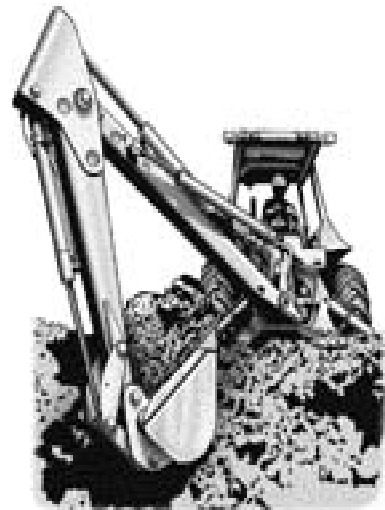

### 4.4 CONSTRUCTION SPECIFICATIONS

Development of spoil and overburden fills may require a series of activities that include site preparation, the installation of surface and subsurface drainage systems, fill placement, and final reclamation.

- ◆ Adequate drainage and sediment control must be provided prior to site preparation and fill construction. These controls are normally installed after tree clearing but before ground disturbing activities. Sediment control may be provided by diversion ditches, diversion berms, sediment basins, sediment ditches, or other approved structures as outlined in this manual.
- ◆ Diversions may be necessary to direct surface drainage from undisturbed areas away from the fill construction area. They may also be used around the perimeter of the fill to direct runoff from the construction area to sediment control structures. Diversions shall be constructed in a manner that will allow access for maintenance equipment along their entire length.
- ◆ All areas under the proposed fill shall be cleared of trees, shrubs and other vegetative debris. Large stumps must be grubbed from foundation areas that will be covered by the sloping face of the fill. Vegetative material, less than six inches in diameter, may windrow below the fill area to provide supplemental sediment control. All useable trees

should be salvaged to promote conservation of that resource. Vegetative material should not be left below fill areas that have less than 25 feet of cover.

- ◇ All topsoil and unstable soil materials must be removed from the fill foundation. These materials shall be stored for use in final reclamation of the fill and other mine areas. Topsoil is particularly helpful in stabilizing sandy slopes since, in most cases, it is more resistant to erosion and more conducive to re-establishing vegetation. Topsoil may be left on the upper, non-structural portion of the fill foundation only if it will not be required for final reclamation and the presence of topsoil will not reduce or impair stability of the fill.
- ◇ Good drainage is necessary to ensure the stability of fills. It is especially important in valleys, hollows or ravines. An underdrain system should be installed to convey the discharge from any seeps or springs to the fill surface. A properly designed and constructed underdrain should prevent these water sources from saturating the fill and causing structural weakness. These underdrains may be constructed of durable stone, perforated pipe, or a combination of the two. The underdrain should be sized to convey the maximum anticipated flow from the seeps or springs. The drain should be composed of durable rock with a minimum dimension of nine inches. However, no single rock in a rock underdrain should exceed one fourth of the total drain width. No more than 10 percent of the drain material should be less than nine inches in size. Underdrains must be provided with adequate filter protection to prevent clogging. (See Figure 4-1)
- ◇ There are two basic ways to construct fills - lift construction or dump construction.
  - Lift construction provides the greatest stability and should be used when constructing fills on steeply sloping ground. In lift construction, fill material is deposited in layers beginning at the toe, or lowest point, of the fill. Each layer should be "stepped", or keyed, into the hillside with a dozer cut to help prevent slides along the fill / hillside interface as weight is added to the fill. Each layer is constructed in a three step process. This starts with placement of material on the last completed layer, or surface, of the fill. As material is hauled in and dumped, care should be taken to maintain room between the piles of dumped material to insure unobstructed drainage from the area. Secondly, as the piled material covers the fill surface, it should be spread into a uniform layer and firmed up with a dozer. The thickness of each fill layer should not exceed four feet. Finally, the new layer is compacted by routing rubber-tired haulage equipment over the entire area. This is done by routing the haulage equipment along a new path each time a trip is made to and from the fill to dump another load of material. The placement of coarser materials in the toe section of the fill will facilitate drainage and enhance fill stability.
  - Dump construction fills are generally easier and faster to construct, but are less stable. This type of fill is commonly used when constructing fills above level or gently sloping ground. They should only be used in areas where stability is not a concern. They should never be used to impound water. These fills are normally constructed in a two-step process. Material is hauled in and dumped short of the face. A rubber-tired loader or dozer is then used to push the material over the face. In some cases, where compaction of the outslope is not a concern, material is end-dumped right over the face.

**Figure 4-1: Cross-Section of Typical Underdrain**

**CROSS-SECTION OF UNDERDRAIN**

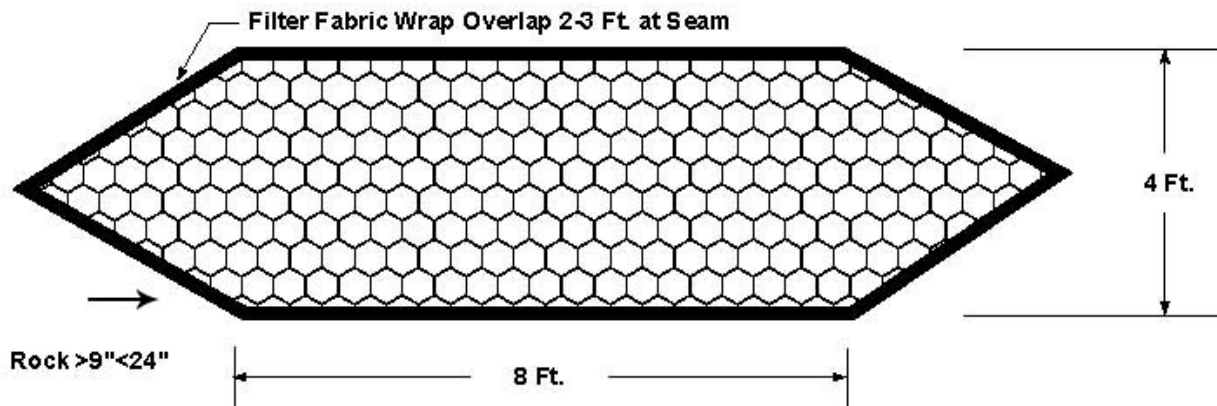

Care should be taken with both types of fills to ensure positive drainage from the top surface and to maintain a safety berm above the outslope, or face of the fill. Haulage equipment should be kept a safe distance back from the edge of the fill.

- ◆ On site generated waste material (steel, conveyor belts, off road tires, etc.) may be disposed of within fills if specifically approved by the Division. This material should never be deposited within the outslope areas of fills. Care should be taken during the placement of this material to ensure that fill material does not bridge across it. Bridged material may collapse after the fill is completed and lead to water entry into the fill and slope failures.
- ◆ The outslopes of the completed fill should be placed on a grade not to exceed two horizontal to one vertical (2:1 or 50%). Fills composed primarily of sandy material should be graded on slopes not to exceed three horizontal to one vertical (3:1 or 33%). Drainage terraces should be constructed in outslopes to decrease the height of the slope and decrease the potential for slope erosion. Slope distances should not exceed 95 feet (2:1 slope 40 feet high or 3:1 slope 30 feet high). Drainage terraces should be sloped back into the fill to ensure that drainage flow stays on the bench and does not overtop its outside edge and erode the outslope. Drainage terraces should be constructed on a one to two percent grade along the face of the fill to drain toward slope drains and sediment control structures.
- ◆ The top of the fill should be crowned and graded at one to three percent toward constructed drainways around the perimeter of the fill. Care should be taken to ensure that water is not impounded on top of the fill. Drainage should only be directed over the outslopes of the fill where pipe or rock slope drains are constructed for that purpose.

- ◆ Rock or pipe slope drains should be adequately sized and spaced to ensure that drainage can be conveyed to the toe of slopes without erosion damage. Earthen berms should be maintained around the top edge of all outslopes to direct runoff to the slope drains. Rock filter berms should be constructed around the inlet of all slope drains to help prevent debris from blocking the drain. (See Pipe Slope Drain section of this manual.)
- ◆ Reclamation of the fill shall be concurrent with fill construction. As each section, or each level of the fill, is completed, it should be faced with four to 12 inches of topsoil and revegetated. Slopes should be tracked in, with a dozer or some other type of track equipment, to hold seed in place and minimize slope erosion. Upon completion of fill placement, the top of the fill shall be graded and seeded in accordance with the approved reclamation plan. The seed mixture should contain at least one perennial grass, one legume and one nurse crop. Lime and fertilizer shall be applied as necessary per soil test results. Mulch shall be applied over all seeded areas and tacked in place to prevent wind scour. Proper application of mulch is particularly important in areas subject to the afternoon sun and prevailing winds as those areas tend to dry faster.

## 4.5 PLAN PREPARATION

The Permit Application or permit amendment must be submitted to the Division for review and approval prior to initiating fill construction activities. The application or amendment needs to address all applicable requirements under section 4VAC25-31-400 of the *Virginia Reclamation Regulations for Mineral Mining*. The following information should be included.

- ◆ A plan narrative that addresses, amongst other things, the purpose of the fill, its size and construction timeframe, the type of material to be placed in the fill, site preparation, drainage and sediment control, fill placement, reclamation and maintenance.
- ◆ A plan view of the fill.
- ◆ Cross-sections of the fill.
- ◆ Designs calculations for drainage and sediment control structures.
- ◆ Designs calculations and specifications for fill construction.
- ◆ A permit map.

Figures 4-2 and 4-3 present a typical hollow fill schematic and generalized cross-sections, respectively. Figures 4-4 and 4-5 present a side hill fill schematic and generalized cross-sections, respectively.

## 4.6 OTHER TYPES OF FILLS

Additional design information may be required to ensure stability of wet material fills or impounding fills. For additional information, contact the Division of Mineral Mining or your engineer.

Figure 4-2: Typical Hollow Fill

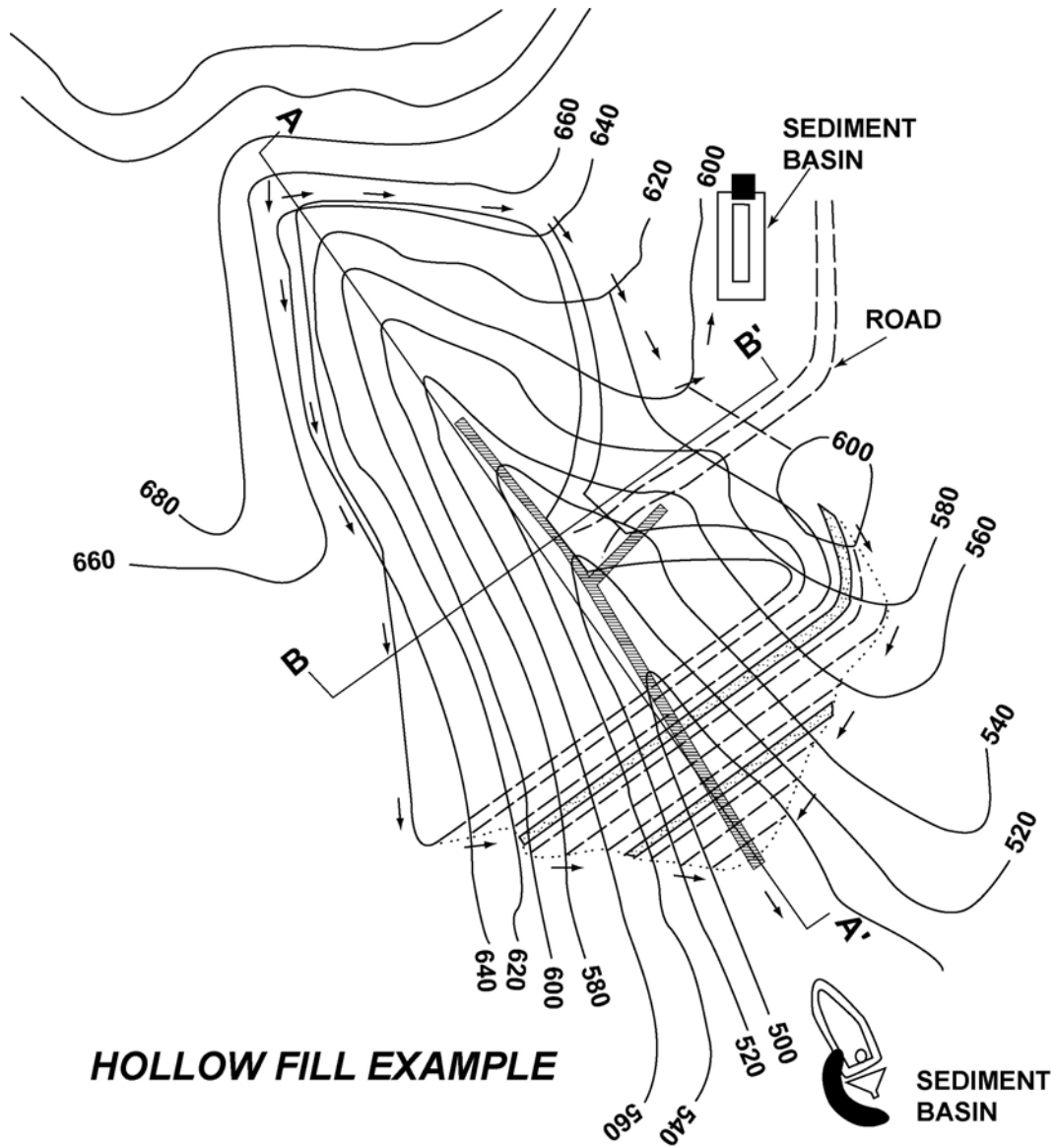

**Figure 4-3: Typical Hollow Fill Generalized Cross Sections**

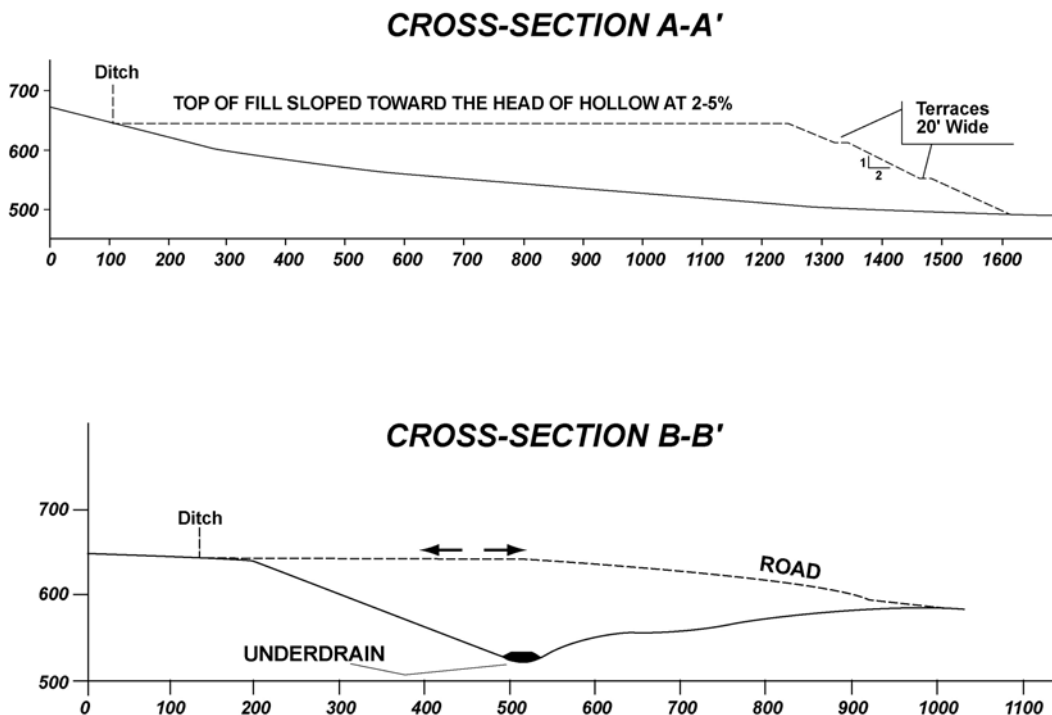
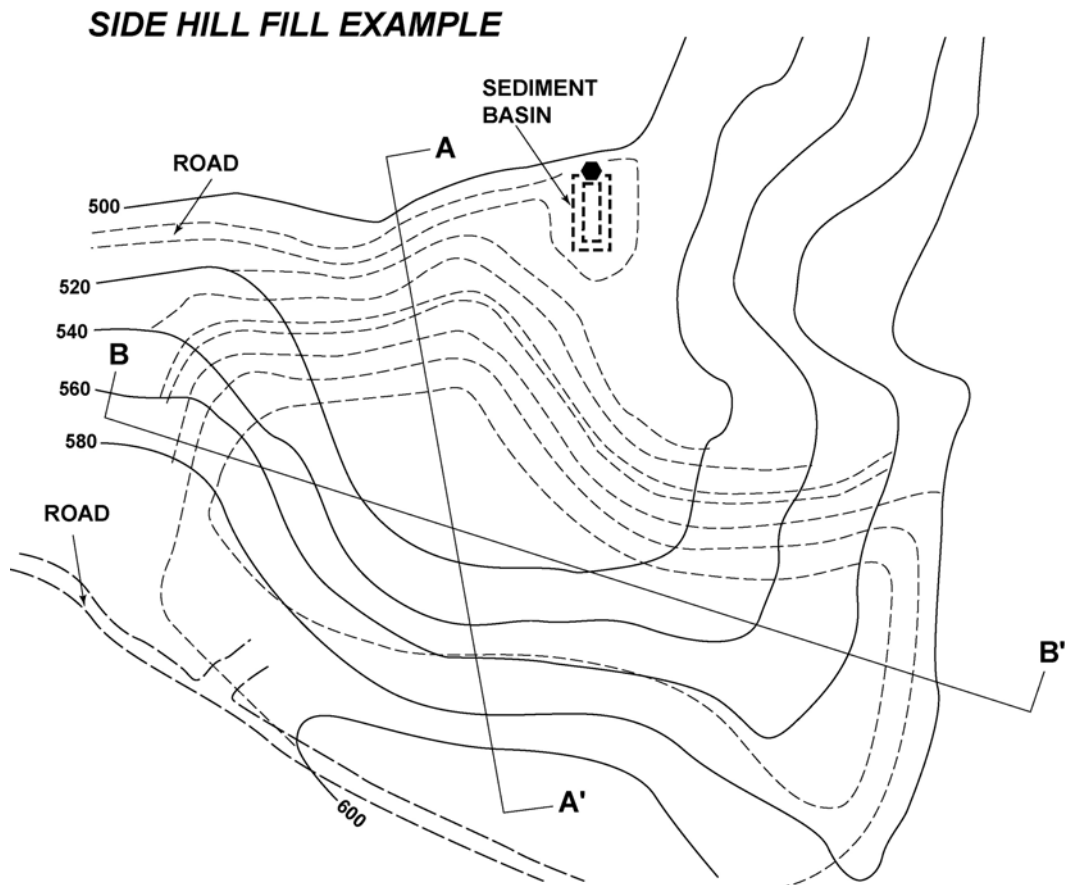
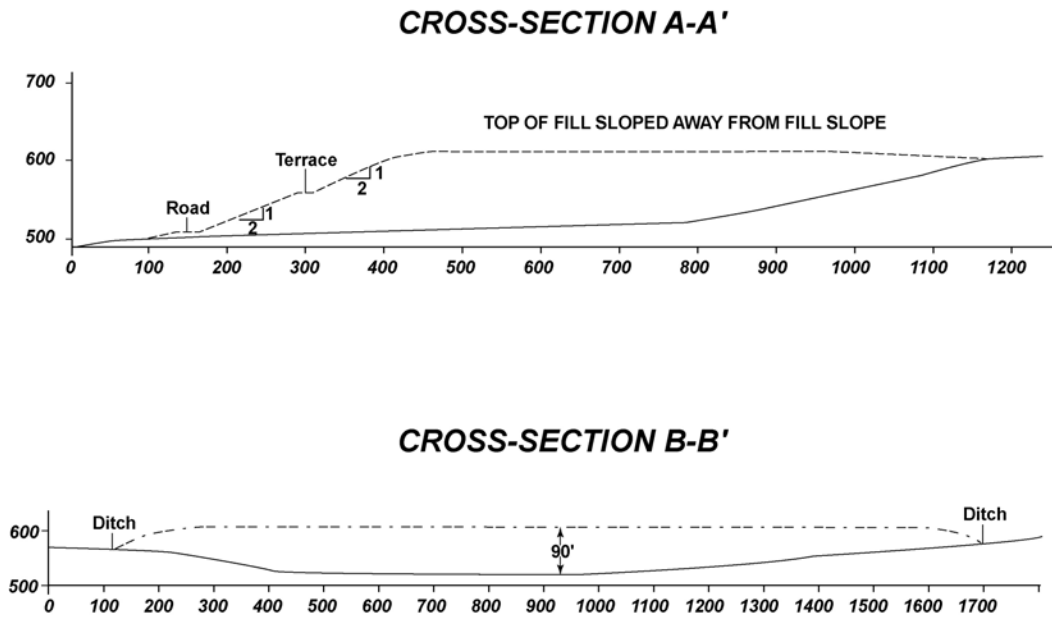



Figure 4-4: Typical Side Hill Fill



**Figure 4-5: Side Hill Fill Generalized Cross-Sections**



## 4.7 DETERMINING THE STOP POINT ON DUMP CONSTRUCTION FILLS

In most cases the active face of a pushed off or end dumped fill will form a near 1:1 or 45 degree slope. To determine the stop point of an active fill slope, you must first determine the location of the final toe. In most cases, the final toe should be kept at least 25 feet away from adjacent property lines or 15 feet away from sediment control structures. The final toe should be marked with stakes and flagging. Once the final toe is established, the active slope stop point can be located. The active slope stop point should be located a distance (D) back from the final toe that is equal to the two times the height (H) of the working level of the fill. This will allow adequate room for construction of the 2:1 slope needed for final reclamation.

Active slope stop point = Distance equal to two times the height of fill being placed

$$\text{Stop Distance (D)} = 2 \times \text{Height of fill (H)}$$

During final grade and reclamation of the outslope, material can be pushed off the top of the fill, or additional material can be added to the slope, to achieve the required 2:1 grade.

The same principle can be applied to the establishment of drainage terraces between fill levels. In this case, the final toe should be staked along the set-back distance (normally 20 feet) for the drainage terrace.

## 4.8 TYPICAL CAUSES OF FILL FAILURES

Table 4-1 lists typical causes of fill failures, both transverse and cylindrical failures.

## 4.9 HELPFUL SLOPE CALCULATIONS AND CONVERSIONS

1:1 = 1 horizontal to 1 vertical distance = 100% grade = 45.0 degrees

2:1 = 2 horizontal to 1 vertical distance = 50 % grade = 26.6 degrees

3:1 = 3 horizontal to 1 vertical distance = 33 % grade = 18.4 degrees

**Problem:** Determine percent grade of a 3:1 slope.

$$\text{percent grade} = 100 \times \text{rise distance} / \text{run distance}$$

$$100 \times 1/3 = 100 \times 0.33 = 33 \%$$

**Problem:** Determine what a 3:1 slope would be in degrees.

$$\text{Tangent of slope} = \text{tangent}(S) = \text{rise distance} / \text{run distance}$$

Where S = slope degrees

$$S = (\text{rise} / \text{run distance}) / \text{tangent} = \text{inverse tangent of (rise / run)}$$

**Table 4-1: Typical Causes Of Fill Failures**

<u>Transverse Failure</u> <i>sliding along an essentially straight plane</i>	<u>Cylindrical Failure</u> <i>rotational sliding along a curved plane</i>
Normally fails at the contact between the fill and original ground.	Normally fails within the fill material itself.
<b>Causes</b>	
Foundation too steep – fill is not stepped or keyed into hillside	Fill outslope too steep
Inadequate compaction	Inadequate compaction
Poorly drained foundation	Poor top surface and subsurface drainage
Weak soils left in foundation (creep, slick)	Placement of saturated fill material
Failure to clear trees and brush from outslope areas	Failure to clear trees and brush from outslope areas
No toe buttress	No toe buttress
<b>Remedies</b>	
Inverse of above	Inverse of above
Extend face and toe to an area as level as possible	Replace weak/wet material with more competent, better drained material
Install adequate underdrains	Install adequate underdrains
Construct a toe buttress to resist sliding	Construct a toe buttress to resist sliding

$S = \text{tangent}^{-1}(\text{rise} / \text{run})$   
(This calculation requires the use of a calculator or tables.)

$S = \text{tangent}^{-1}(1/3) = 18.4 \text{ degrees}$

**Problem:** Determine the slope distance for a 2:1 slope and 25 ft. elevation difference.

Slope = 2:1 = 26.6 degrees

Sine of slope = Sine (S) = rise distance / slope distance

Where S = slope degrees

Slope distance = rise distance / Sine (S)  
(This calculation requires the use of a calculator or tables.)

Slope distance = 25' / Sine (26.6 degrees) = 25' / 0.45 = 56 feet

**Problem:** Determine the height of a vertical wall using a run distance and slope angle.

Mark a point in the floor of the pit a safe distance out from the wall to be measured. Using an Abney level, stand a safe distance back from the edge of the wall and measure the slope degrees (S) across the top edge of the wall to the point marked on the pit floor. Using due caution, measure the run distance from the base of the wall to the point marked on the pit floor.

For the purpose of this problem, assume run distance = 125 feet and slope angle was measured at 30 degrees.

Tangent of slope = Tangent (S) = rise distance / run distance

Where S = slope degrees

Rise distance = run distance x Tangent (S)

Rise = 125 ft x Tan (30 degrees) = 125 ft x 0.58 = 72.5 feet

This page intentionally left blank.

## 5 REVEGETATION

### 5.1 PLANNING FOR REVEGETATION

A well-defined mining plan will create order and objectivity to the entire mining operation, including reclamation. Such a plan would include maps showing contour lines, natural and man-made drainage ways, public and company roads, physical structures, screens (both vegetated and man-made), plant species to be used, and special planting mediums as determined by the plant species to be used and the potential use of the land. Maps need to be drawn to approximate scale in order to present a reasonably accurate picture of the appearance of the area during and following operations. Such a map would be very useful in working with adjacent communities and local governing bodies.

The revegetation plan should include a narrative section for describing the objectives of the plan, sequence of events towards its development, and the desired overall effect.

### 5.2 PUBLIC CONSIDERATIONS

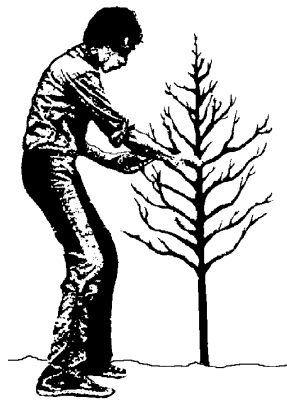

Property values and lifestyles are the primary concerns of the local public where mine operations are being considered, or are underway, as well as the employment opportunities they provide. The general public is concerned with the future use of the land, as well as the appearance of the mine site during and following operations. Society is also concerned in having the use of the product being mined at the lowest possible cost. A well conceived and executed mining, reclamation, and revegetation plan shows consideration for public as well as operational needs.

### 5.3 OPERATIONAL CONSIDERATIONS

How the mining operation is planned and carried out will have a great effect on the revegetation aspect of the mining operation. Continued disturbance of the mined area during mining operations makes it difficult to obtain the maximum benefit from revegetation efforts, especially from the establishment of perennial or permanent types of vegetation. By mining the permit systematically, parts of the mines can be simultaneously reclaimed to achieve permanent vegetative cover.

### 5.4 DEVELOPING A FAVORABLE PLANTING MEDIUM

Mine operators can create a favorable growing medium from overburden and soil materials generated during the mining operation. By careful selection, segregation and handling of these materials, a medium with the proper physical and chemical properties can be achieved. It is important during the selection process to consider pH, nutrient content, and media composition (sand, silt, clay). All these aspects are important in developing a medium that will sustain long-term vegetative cover.

Most mine operators have a general knowledge of the geologic and soil conditions in the area that they mine. They may not however have the ability to determine the specific chemical and physical characteristics necessary to achieve successful revegetation of the lands disturbed by mining. Assistance is available in determining necessary soil

supplements, such as lime, fertilizer, or organic matter; and which type of plants are most suitable in achieving long term vegetative cover and land restoration. Operators can contact the DMM mine inspector, county extension agent, Natural Resources Conservation Service, or Virginia Department of Forestry for questions and assistance.

The most limiting factor on plant growth is soil moisture. Shallow soils and spoil layers, which restrict root growth, commonly contribute to drought like conditions. Materials toxic to root development and plant growth must be excluded from the five-foot surface layer. Certain stratum in overburden may contain plant nutrient bearing minerals (e.g., phosphorus, potassium, calcium, magnesium), as well as micronutrients, which could be set aside for use in the growing medium.

The major factors in developing a suitable planting medium are:

1. Depth of soil media, a four- to five-foot depth of non-toxic material, with desirable physical and chemical properties, is needed on the surface as a growing medium for revegetation;
2. Segregation and stockpiling of overburden with desirable properties for the growing medium;
3. Analysis of media, testing for toxic and suitable materials in overburden;
4. Development and techniques for recognizing non-toxic and toxic materials in overburden, as well as the potential for toxicity in by-product materials; and
5. Placement of any toxic, potentially toxic, and otherwise unsuitable materials below the surface five-foot layer.

## **5.5 SELECTING MATERIAL FOR PLANTING MEDIUM**

In terms of humus content (i.e., favorable loam-like properties and low content of toxic material), the natural surface soil is most suitable as a growth medium for plants. The partially decomposed rock material beneath topsoil can also be used in the five-foot surface layer.

Some soils in poorly drained areas of the coastal plain region form acids when the underlying layers high in sulfide minerals are exposed to air and moisture. Material from these layers may be buried and covered with a minimum of five feet of non-toxic material to prevent surface contamination of soils and water.

Some soils in Virginia have very heavy clay sub-soils, which restrict root growth. These are more commonly found in northern Virginia. The heavy clay layers from these soils should be buried five feet deep and covered with more friable material. Soil scientists from the Extension Service and the Natural Resources Conservation Service can assist operators in identifying heavy clay layers in soils as well as friable material to substitute for it.

Overburden can contain acid forming minerals or base forming minerals. The resulting soil reaction, or pH, is dependent upon the proportion and type of minerals present. Minerals high in calcium, magnesium, potassium, and sodium are more likely to produce neutral to



alkaline soil upon weathering. Minerals containing sulfur oxidize in the presence of air and water to form strongly acidic soil conditions.

Overburden material, or by-products of certain processing operations, can contain concentrations of certain elements that are toxic to plant growth. Toxic producing materials include by-products, or waste materials, containing toxic levels of manganese, iron, zinc, and certain other heavy metals. Ground limestone (minus 20 mesh) and residues of burnt and hydrated lime are also toxic to plant growth when they comprise a substantial proportion of the growing medium. Materials toxic to plant growth must be buried at least five feet deep, to avoid pollution and revegetation problems.

## 5.6 TESTS USEFUL IN SELECTING OVERBURDEN MATERIALS

Rock layers or overburden strata often vary in chemical and physical properties from those above or below them. Samples from the different layers can be tested for mineral content, calcium carbonate (lime) equivalent, and minerals containing the plant nutrients phosphorus and potassium. Routine soil sampling tests include:

1. pH test. The critical pH level is 4.0. Material with pH values below 4.0 generally contains toxic concentrations of sulfide minerals. Material with pH values above 4.5, preferably above 5, is safe to use as a planting medium.
2. Soil tests. These tests will provide an indication of the dilute acid extractable phosphorus, potassium, calcium, and magnesium content of overburden material and its pH level. The tests may or may not be an accurate indication of the availability of plant nutrients for plant growth, but may be a guide as to whether or not minerals containing these plant nutrients are present in the overburden. The above tests are run routinely. Additional tests for soluble salts, manganese, and zinc can be useful.
3. Other tests. Overburden samples can be sent to commercial laboratories for tests on acid forming sulfides, basic minerals, heavy metals, and minerals containing phosphorus and potassium. Such tests provide information on the mineral content of rock layers or overburden strata.

## 5.7 COMPOSITION OF PLANTING MEDIUM

The proportions of rock to soil in mine spoil influences the amount of air movement, the evaporation rate, and the amount of water available for plants. Spoil composed of rock and coarse rock fragments usually has too much internal air movement and therefore, is prone to be drought like. However, too much clay or silt may form a dry, tightly packed soil that can prevent germination of seeds and seedling emergence. Soils with a mixture of small rocks and soil are best for seedbeds and planting of all types.

An inadequate amount of soil and finer textured overburden in the surface of mine spoils is another common problem. If at all possible, overburden consisting of surface soil and finer textured spoil material should be saved, and stockpiled for coverage of large and intermediate type rocks, as well as toxic materials. Forming the surface layer from such materials will increase the success of new seedlings and other plantings.

Spoil material arrangement may also influence the success of revegetation. A deep layer of large and medium size rock material on the surface contributes to a droughty condition. For best results and ease of planting, coarse spoil materials should be covered with three to four feet of soil, or a mixture of soil and small rocks. Figure 5-1 illustrates soil structuring and use of different size rock material for conserving moisture and improving revegetation success. The finer materials are placed on the surface to reduce the movement of air through the large spaces surrounding the coarser rock fragments. Reduction in the movement of air through the soil reduces loss of moisture by evaporation.

Soil and fine textured overburden placed on the surface increases the success of seeding and revegetation on mine spoils. Soil containing humus, releases nitrogen and phosphorus as it degrades, creating an available form for the growth of plants. Soil also has a much greater moisture-holding capacity than coarse spoil material. Natural soil materials contain microorganisms that assist in improving soil aggregation, and organic matter content. They also aid in the release of plant nutrients.

## **5.8 SURFACE AND SEEDBED CHARACTERISTICS**

A moderately rough surface made with dozer tracking or disc harrow is the best type of surface for broadcast seeding. The seed falls into depressions between clods or into small cracks where it may germinate and establish.

The first one to two feet of soil should be free of rocks larger than three inches in diameter with one third to one half of the weight made up of sand, silt, and clay sized material. Silt and clay tends to seal overburden from rainfall, and rock material can be difficult to vegetate as it lacks the ability to retain water.

## **5.9 SOIL TESTING, LIMING AND FERTILIZATION**

The lime and fertilizer requirement for revegetation of mined areas depend upon the intent of revegetation. If revegetation is mainly for erosion control, stabilization, and wildlife habitat, only moderate amounts of lime and fertilizer are needed depending upon results of soil tests. Vegetation to be used for grazing by livestock, or harvested for forage, should use lime and fertilization application programs comparable to those used for agricultural purposes.

### **Soil Testing**

Soil testing and analysis must be an integral part of any reclamation program. Proper testing is used to determine the amounts of lime and fertilizer that must be applied to mined areas. This testing can save on lime, fertilizer, seed, labor, and machine use, as well as increase the rate of plant growth, expediting the reduction or release of bond.

Soil test measurements, including the degree of acidity, pH, and soluble salts, reveal much about the suitability of spoil or mined areas for revegetation. However, one or more plant nutrients can also be so deficient as to limit or prevent growth of plants.

Spoil samples can be sent to the Virginia Tech Soil Testing Laboratory in Blacksburg for analysis. Local Cooperative Extension Offices in counties or cities throughout the state can provide soil sample boxes and information sheets. The results of the tests are sent to the Extension Agent who develops lime and fertilizer recommendations for the use indicated by

the landowner and/or mine operator. Extension Agents, Natural Resources Conservation Service personnel, and DMM Inspectors have sampling supplies and can discuss in detail how to obtain representative samples.

**Figure 5-1: Soil and Rock Structuring to Improve Revegetation**

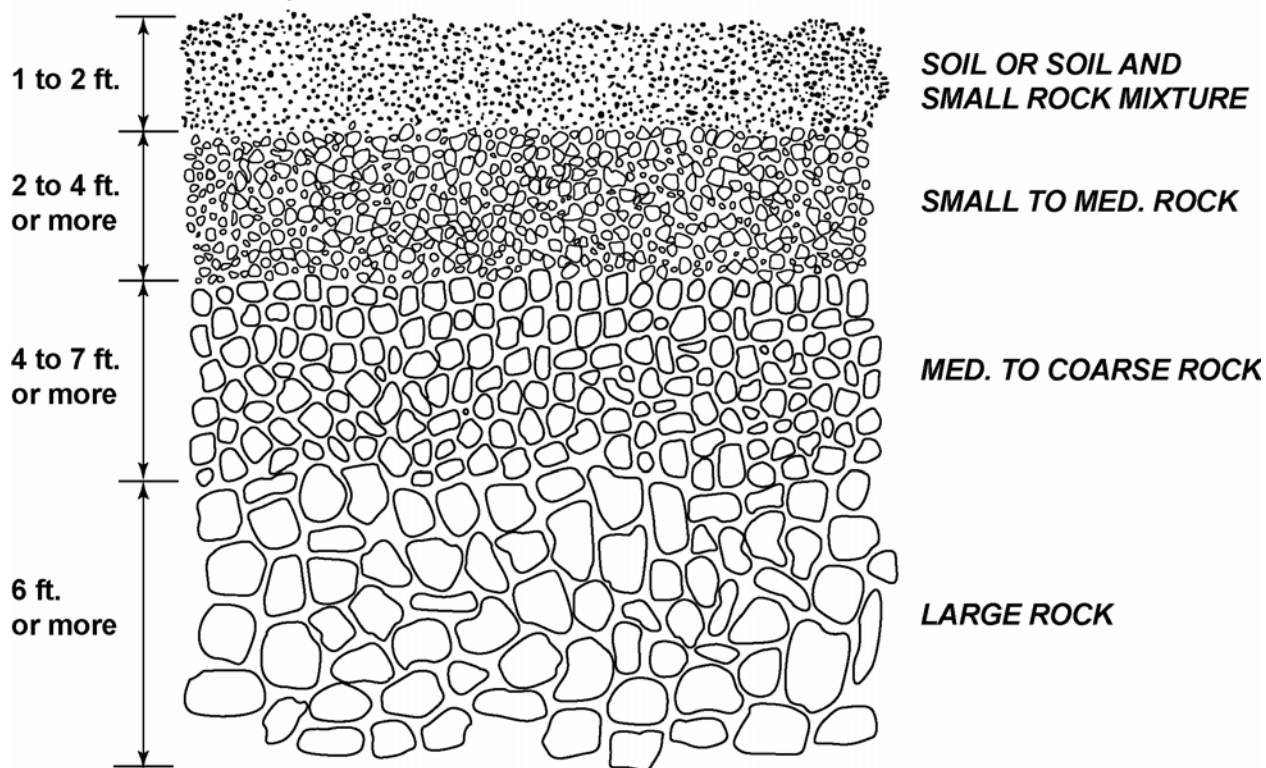

**Suggested layering of different size spoil material for revegetation of surface mine spoils.**

### Collecting Soil-Spoil Samples

Spoil samples that are improperly taken are misleading and lead to poor germination, seedling growth, and vegetative cover. A typical sample should weigh approximately half a pound. Care should be taken when collecting samples. It must be done properly for such a small sample to adequately represent several acres of spoil. To obtain a representative sample, it is necessary to collect, in a clean bucket, 15 to 20 sub-samples of about the same quantity. Depth of sampling should be four to six inches. A small pick and/or mattock and garden trowel are the best tools for collecting spoil samples. The area represented by one sample should not be more than two to five acres depending upon uniformity of the spoil. In sampling spoil, collect sub-samples that are uniform in color, rock material, and amount of soil. Suspected problem areas should be sampled separately.

### Lime

Lime is used to raise spoil and soil pH. Few plants can survive in spoil material when the pH is below four. Most plants have poor growth when the pH is below five. In general, where stabilization, erosion control, or wildlife habitat is the main concern, the pH of spoil

should be raised to five and a half or above. Certain plant species, however, may require an even higher pH level to achieve optimal growth.

Based on soil tests, soil type, soil pH and type of vegetation to be planted, correct lime rates per acre can be established. Liming before hydro seeding is preferred since this will give lime time to work into soil and increase the pH. A routine test package for soil samples can be obtained through the Virginia Tech Soil Testing Laboratory. The package includes recommendations on the use of fertilizer and lime.

## 5.10 FERTILIZATION

Mine spoils are generally deficient in nitrogen and can have varying levels of phosphorus and potassium. Soil test information on spoil material takes the guesswork out of planning a lime and fertilization program. It will increase the likelihood of successfully revegetating areas after initial seed application.

Nitrogen and phosphorus are especially important for new seedlings on mine spoil. A readily available source of phosphorus assures good seed germination and growth through the seedling stage, while nitrogen promotes rapid top growth and vegetative cover. Potassium, while important during the seedling stage of development, has a greater influence at later stages of growth.

The post mining use of the area (e.g., recreation, agriculture, etc.) will determine the type of fertilization used on spoil materials. It is advisable to keep records of what has worked in the past for similar soils.

Legumes play an important role in the long-term success of revegetation on mined areas. Properly inoculated with Rhizobium bacteria, legumes are capable of fixing atmospheric nitrogen. The legume uses the nitrogen fixed in this manner and a certain amount becomes available to other vegetation present in the mixture. Grasses are unable to provide for their own nitrogen needs and must obtain it from the breakdown of organic matter, nitrogen based fertilizer, or an associated legume.

## 5.11 GRASS AND LEGUME MIXTURES AND THEIR ESTABLISHMENT

The principle objective in reclaiming mined areas is the control of erosion and sediment loss. Revegetation with perennial type grasses and legumes is a practical and rapid means for stabilizing drastically disturbed land areas. In addition to controlling erosion and loss of sediment to streams, other benefits such as forage and crop production, tree plantations, and wildlife habitat can be realized.

### Seeding Dates

Seeding or planting at the right time is very important in obtaining acceptable vegetative cover. All plant species have an optimum time period for seeding or planting. For best results, cool season species need to be planted during early to mid-spring or early to mid-fall. Warm season species can be planted during the early summer months

## **Seeding Methods**

A suitable seedbed is first prepared in order to have a reasonable degree of success in establishing adequate and uniform stands. In areas where conventional agricultural equipment cannot be used to prepare the seedbed, the seed should be loosely spread on the recently re-graded surface.

Grain drills, hydro seeders, and the manually operated cyclone seeder can uniformly distribute seed. Grain drills are only useful in areas where the soil medium is relatively free of rock. Hydro seeders are capable of applying seed, fertilizer, mulches, and legume inoculum in one operation. Continuous mixing is necessary for even distribution when different seed species, fertilizers, and mulches are applied at the same time.

## **Native and Reclamation Grasses**

Tables 5-1 and 5-2 identify different types of grasses that may be used for revegetation. Table 5-1 identifies turf type perennial ryegrasses. Table 5-2 includes the common name, scientific name, plant height, growing season, texture and type of growth, planting times, recommended seed rates (lbs./acre), and comments. The tables can be used to develop seed mixtures depending on type of cover desired (i.e., lawn areas, entrance ways, office areas, wildlife habitat, erosion control, and type of slopes). Usually more than one type of seed is used in a seed mixture. The overall mixture is based on the desired end result and should include fast growing species to provide shade and protection for seeds that take longer to germinate. Using these charts and consulting with the DMM Mine Inspector, Department of Game and Inland Fisheries, Department of Forestry, Department of Transportation and other sources, the operator can select a seed mixture that will give good results.

## **Recommended Seeding Specifications**

For best results, the seeding of the disturbed areas must be accomplished immediately after completion and approval of re-grading.

The project area may be seeded and protected using a hydro seeder and straw blower. Twenty-five percent of the wood fiber mulch should be applied while seeding to identify or mark seeded areas. Seventy-five percent of the wood fiber mulch should be applied as tacking over the straw. Straw and mulch should be applied leaving no more than ten percent of the soil's surface exposed.

The seed and fertilizer are applied separately. Under no circumstances should fertilizer be allowed to mix with inoculated seed. Lime, as determined by a soil test, should be used on all disturbed areas. Lime applied at two tons per acre is normally satisfactory.

The Virginia Department of Agriculture and Consumer Services should certify all seed used as to percent germination and purity.

Tables 5-1 and 5-2 list various types of grasses that have proved successful in establishing vegetation on a variety of abandoned mine spoils throughout Virginia. The amount seeded may be reduced by up to a third for non-critical areas, flats, and good soil areas. These mixes provide a favorable habitat for a variety of species to develop. Both mixes support

legumes as the permanent and most dominant species, and will allow natural reforestation or seedlings to develop.

**Table 5-1: Turf Type Perennial Ryegrass**

Turf type perennial ryegrasses are excellent for use when rapid establishment is essential. They may be used in mixtures, but will tend to dominate the stand if percentage of ryegrass is too high. Ryegrasses are also excellent for use in high traffic areas such as athletic fields. The newer varieties have good drought tolerance, but may require irrigation if under drought stress or heavy traffic.

**Bare Ground**—6 to 8 pounds per 1,000 square feet.

**Overseed**—4 to 6 pounds per 1,000 square feet.

**Overseed Warm Season Grasses**—8 to 12 pounds per 1,000 square feet.

VARIETY	Color	Leaf Texture	Spring Green Up	Heat Tolerance	Drought Tolerance	Leaf Spot	Red Thread	Brown Patch	Endophyte Level	Recommended for use in Virginia
Citation II	G	G	E	E	G	G	G	G		√
Dandy	G	G	P	E	E	G	G			
Goalie	P	G	P	E	P	E	E	P		√
Palmer	G	G	G	G	G	G	G	G		√
Palmer II	E	E	G	G	E	G	G	E	E	
Prelude	G	G	G	G	G	G	G	G		√
Prelude II	E	E	G	E	E	G	P	E	E	
Rebel	G	G	E	E	E	G	P	G	E	√
Rebel II	E	E	G	G	G	G	E	E	E	
Sun Rye 246	G	G	G	G	G	G	G	G		
Target	G	G	P	G	G	G	E	E		
Linn (common)	P	P	G	P	P	P	G	P		
Alliance Blend	E	E	E	E	E	G	E	E		√
Medalist Blend	10 E	E	E	P	P	E	E	E		

E—Excellent

G—Good

P—Poor





**Table 5-2: Highway and Erosion Control Seeds**

<b>Native and Reclamation Grasses</b>						
Common Name Scientific Name Varieties	Height <sup>1</sup>	Cool or Warm Season	Bunchgrass or Sod Former	Planting Time <sup>2</sup>	Seeding Rate (lbs./acre)	Adaptation and Comments
Redtop Agrostis alba	T	C	S	F/S	2 Mixtures	Quick cover for grassed waterways, diversions, road-banks. Produces an effective cover the first year. Grows in low-fertility, very acid, clayey, loamy and sandy soils. Fair drought tolerance; poor shade tolerance, will tolerate poorly drained soil. Widely used as a component in mixtures.
Bermudagrass Cynodon dactylon	S-T	W	S	S/Sum/F	40-75	Used as turf in athletic fields for stabilizing disturbed areas that are to be mowed. Bermudagrass grows only in the warmer time of the year and turns brown in the Fall after the first frost. Grows in low-fertility acid, clayey, loamy and sandy soils; excellent drought tolerance; poor shade tolerance; tolerates moderately well in drained soils. Use "hulled" seed in the Spring, "un-hulled" seed in the Fall.
Orchardgrass Dactylis glomerata 'Potomac'	M-T	C	B	F/S	8-15 Pure Stand  3-12 Mixtures	Primarily used for pasture or forage, Orchardgrass is long-lived and deep-rooted. The variety 'Potomac' has vigorous growth, rust resistance, leafiness, and persistence. Best time for planting is in the Fall. May be Spring planted.
Weeping Lovegrass Eragrostis curvula	M-T	W	B	S/Sum	20-40 Pure Stand  4-20 Mixtures	Fast growing cover for erosion control; may be a permanent cover on southern exposures and deep sandy soils; good nesting cover for birds. Produces complete cover in four to five months. Grows in low-fertility acid, loamy and sandy soils; excellent drought tolerance; poor shade tolerance; requires well-drained soil. Weeping Lovegrass can be established by seeding after severe Winter frosts have ended through July.

<sup>1</sup>Short (S) is 1-12 inches; Medium (M) is 13-24 inches; and Tall (T) is 25 inches or taller.

<sup>2</sup> F-Fall; F/S-Fall or Spring; S-Spring; Sum-Summer.

<b>Native and Reclamation Grasses</b>						
Common Name Scientific Name Varieties	Height <sup>1</sup>	Cool or Warm Season	Bunchgrass or Sod Former	Planting Time <sup>2</sup>	Seeding Rate (lbs./acre)	Adaptation and Comments
Tall Fescue Fescue arundinacea 'Kentucky 31' 'Maximize'	T	C	B	F/S	175-250 Pure Stand  40-100 Forage	Most versatile and widely used grass for conservation in the transition Zone. Stabilizes grassed waterways, streams and road-banks; used as a turfgrass for lawns; food for geese, deer and cottontail; cover for birds; forage for winter grazing. Use the variety "Maximize" for livestock, as it does not contain endophytes, which have been found harmful to grazing animals. Good drought tolerance; fair shade tolerance; somewhat tolerant to poorly drained soils. Please see the turfgrass section for improved Turf-Type varieties of Tall Fescue.
Hard Fescue Festuca longifolia 'Scaldis' 'Aurora'	M	C	B	F/S	130-170	Ideal for low maintenance sites such as cemeteries, parks, roadsides, ski slopes, industrial sites and reclamation area. Produces complete cover within one year. Very adaptable turfgrass that performs well in sun or shade without fertilization or supplemental irrigation. Hard Fescue produces a hardy, attractive, leafy turf of fine texture with a dark green color. Can be used as a companion grass in wildflower mixtures.
Sheep's Fescue Festuca Ovina 'MX-86' 'Bighorn'	M	C	B	F/S	175-250	Small bunchgrass with blue-green foliage that is tolerant to drought and gravelly or exposed sites. Adapts well to well-drained, medium textured soils. Sheep's fescue is an attractive grass that is frequently used in wildflower mixtures.

<b>Native and Reclamation Grasses</b>						
Common Name Scientific Name Varieties	Height <sup>1</sup>	Cool or Warm Season	Bunchgrass or Sod Former	Planting Time <sup>2</sup>	Seeding Rate (lbs./acre)	Adaptation and Comments
Red Fescue <i>Festuca rubra</i> 'Pennlawn'	M-T	C	S	F/S	125-175	Red Fescue has narrow, bright-green leaves. It spreads by short, underground stems to produce a tight sod. Grows in medium-fertility, slightly acid, clayey and loamy soils; fair drought tolerance; good shade tolerance; requires well-drained soil. For use in fine textured lawn mixtures.
Annual Ryegrass <i>Lolium</i> <i>Multiflorum</i>	T	C	A <sup>3</sup>	F/S	10-30 Mixtures	Used primarily as a temporary cover or nurse grass, to allow for germination of proprietary seeds, generally used in mixes for erosion control. Can be planted from early March to early May and from early August to mid October. Grows best in neutral to slightly acid, moist soils of moderate to high fertility.
Perennial Ryegrass <i>Lolium perenne</i>	M-T	C	B	F/S	125-200	Fast-growing, short-term stabilizing cover. Also used for soil improvement, lawns (see Turfgrass section), and pastures. Grows in medium fertility, slightly acid, clayey and loamy soils. Rapid growth rate is the primary conservation value of perennial ryegrass. Establish by drilling or broadcasting seed with mulch in Spring or Fall.
Reeds Canarygrass <i>Phalaris</i> <i>arundinacea</i>	T	C	S	F/S	12-15	One of the best grasses for swampy and wet areas. Performs well on poorly drained soils, tolerates moderate salt and alkali. Will withstand flooding, yet is quite drought tolerant when mature. An excellent grass for stabilizing waterways, healing and controlling gullies, and protecting shorelines of ponds and reservoirs from wave action. Grows 4 to 7 feet, providing good cover for shooting preserves.

<sup>3</sup> Annual Grass (A): Grasses that do not live longer than one year.

<b>Native and Reclamation Grasses</b>						
Common Name Scientific Name Varieties	Height <sup>1</sup>	Cool or Warm Season	Bunchgrass or Sod Former	Planting Time <sup>2</sup>	Seeding Rate (lbs./acre)	Adaptation and Comments
Kentucky Bluegrass <i>Poa pratensis</i>	M	C	S	F/S	120 Pure Stand	Used for lawns, pasture, recreational, turf and erosion control. Choice food for grouse, turkeys, deer, and rabbits. Becomes dormant during dry or hot weather; however, it will normally survive severe drought. Requires a firm, weed-free seedbed. And a fertilizer high in phosphorous. Adequate lime is important, also. This grass is usually seeded with a mixture of other grasses or legumes, several varieties of Bluegrass should be used together to ensure good stand survival. See Turfgrass section for improved varieties of Kentucky Bluegrass.
Cereal Ryegrass <i>Secale cereale</i> 'Abruzzi'	T	C	A+	F/S	100 Pure Stand 10-15 Mixtures	Often referred to as Winter Rye because of its Winter hardiness, it is the most commonly used small grain grass for soil stabilization. Provides temporary cover in the Fall and Winter months. Germinates quickly and is tolerant of poor soils.
Foxtail Millet <i>Setaria italica</i> 'German Strain'	T	W	A+	F/S/Sum	25-45 Pure Stand 10-20 Mixtures	May be used as a quick cover component of mixtures from May through July for erosion control and forage. Dies at first frost.
Crownvetch <i>Coronilla varia</i> 'Penngift'	M-T	C	G	F/S	15-20 Mixtures	Used as a group cover for steep road banks, mine spoil and industrial waste sites, where low maintenance is important. It is also useful as a residential ground cover, and provides forage for wildlife. Crownvetch grows best on well-drained soils and will persist on more acid soils for a prolonged period once established. Seeding in the Spring is the most successful. Since an established stand of Crownvetch takes 2-3 years, it is recommended that a companion grass such as Perennial Ryegrass or Redtop be added to the initial planting. Crownvetch grows aggressively and blooms profusely during May and June. Can also be established by planting crowns or root divisions.

<b>Native and Reclamation Grasses</b>						
Common Name Scientific Name Varieties	Height <sup>1</sup>	Cool or Warm Season	Bunchgrass or Sod Former	Planting Time <sup>2</sup>	Seeding Rate (lbs./acre)	Adaptation and Comments
Chewings Fescue <i>Festuca rubra</i> <i>commutata</i> 'Jamestown II'	M-T	C	S	F/S	130-170	Ideal for low maintenance areas such as estates, parks and cemeteries. Also used for erosion control. It is a dark green, low growing turf grass with fine leaves and abundant tillering. It is persistent under low cutting and gives a close-knit, fast-establishing turf. Does best in shade and dry, infertile conditions. Grows in acidic, dry soils and is tolerant of drought stress.
Flatpea <i>Lathyrus</i> <i>sylvestris</i> 'Lathco'	M-T	C	G	F/S/Sum	20-40 Pure Stand 15-20 Mixtures	Deep-rooted, viny legume that grows to a height of 30 inches. Used for erosion control on road banks, logging roads, dams, gravel pits, mine spoil and industrial waste areas; cover for small mammals. Flatpea produces cover in 2-3 years, and should be planted with tall fescue or other fast-growing grasses. Flatpea is adaptable to a wide variety of soil conditions. Has excellent drought tolerance; good shade tolerance; requires well-drained soil; tolerates more acid and droughty sites than most legumes.
Bicolor <i>Lespedeza</i> <i>Lespedeza</i> <i>bicolor</i>	T	W	FR	S	15-20 Mixtures	Used as a food for quail, dove and wild turkey, and cover for these and other birds and mammals. Grows in most soil conditions except those with poor drainage. Bicolor Lespedeza is an upright shrub that grows to a height of 12 feet. The plants will produce seed in three to four years, which provides food for quail. Establish by direct seeding or by planting seedlings in early Spring. Plant in strips, borders or compact blocks to provide both food and cover.

<b>Native and Reclamation Grasses</b>						
Common Name Scientific Name Varieties	Height <sup>1</sup>	Cool or Warm Season	Bunchgrass or Sod Former	Planting Time <sup>2</sup>	Seeding Rate (lbs./acre)	Adaptation and Comments
Annual Lespedezas Lespedeza striata 'Korean' Lespedeza stipulaceae 'Kobe' (common)	S	W	A	S	40 Pure Stand 25 Mixtures	Annual warm season legumes used in pasture, hay, erosion control, soil improvement and wildlife food. Korean Lespedeza is larger and coarser than Common, or Kobe Lespedeza and grows to about 12 inches. Will grow in soil textures ranging from sands to clays and through a wide range of fertility conditions. May be seeded alone or mixed with grasses or small grains. Should not be mowed at less than three inches.
Birdsfoot Trefoil Lotus corniculatus	M	C	G	F/S	20-30 Mixtures	Birdsfoot Trefoil is an herbaceous forage legume that grows to a height of 1-2 feet. It is used in erosion control, soil improvement, and as forage for livestock and deer. Produces bright yellow blooms May through July. Grows better on poorly drained soil than most legumes, but is not as drought or heat tolerant as Flatpea or Crownvetch. Does not tolerate shade very well. Establish by seeding in April, in early May, or early in Fall.
Deer Tongue Panicum clandestinum	M-T	C	G	S/Sum	10-20 Mixtures	Plant cover for acid, infertile and dry sites such as old strip-mined spoils or acidic coal wastes. Also excellent feed and cover for deer and turkey. Produces a dense stand in 3-4 years. Therefore, a temporary cover species (Birdsfoot Trefoil, Weeping Lovegrass, small grains, i.e., oats) should be used in conjunction to aid in the establishment of Deer Tongue. Does well in low fertility or acid soils that are well drained or poorly drained. Deer Tongue may be seeded from March to early July. Do not add Deer Tongue to seed mixtures containing Tall Fescues or Ryegrass as they will out-compete the Deer Tongue.

<b>Native and Reclamation Grasses</b>						
Common Name Scientific Name Varieties	Height <sup>1</sup>	Cool or Warm Season	Bunchgrass or Sod Former	Planting Time <sup>2</sup>	Seeding Rate (lbs./acre)	Adaptation and Comments
Medium Red Clover Trifolium pratense	T	C	G	F/S	8-10 Pure Stand 2-8 Mixtures	Tall, short-lived perennial (actually a biennial), used widely in pasture mixes, as a rotation crop, and as a companion to legumes for forage land. Adapted to cool, moist sites. Poor acid tolerance. Easily established from early Spring through 30 days prior to first frost.
White Dutch Clover	C	S	G	F/S	2-6 Mixtures	Short, shallow-rooted, creeping perennial, used widely in pasture and lawn mixtures. Adapted to cool, moist sites. Slightly acidic to mildly alkaline tolerant. Easily established; cold hardy.
Ladino Clover Trifolium repens latum	T	C	G	F/S	2-6 Mixtures	Ladino white clover is very similar to White Dutch clover in all respects except size. It is a tall growing variety with thick stems and stolons that is used primarily in pastures with tall growing grasses, and in mined land reclamation.



## Low Growing Mix Suitable for Planting Seedlings

Orchard Grass—5 lbs./acre

Perennial Ryegrass—20 lbs./acre

Annual Ryegrass—15 lbs./acre

Redtop—5 lbs./acre

\*Birdsfoot Trefoil—5 lbs./acre

\*Appalow Lespedeza—20 lbs./acre\*

\*Crownvetch—10 lbs./acre\*

\*Ladino Clover—5 lbs./acre\*

\*Red Clover—5 lbs./acre\*

\*Deertongue—5 lbs./acre\*

Straw—3,000 lbs./acre

Wood Fiber/Paper Mulch—1,000 lbs./acre

Lime—Pulverized Agricultural Lime during seeding—2 tons/acre or as determined by soil testing

Fertilizer—10-20-10 - 500 lbs./acre or as determined by soil testing (recommended)

Hydro seeders can also be used for applying finely ground agricultural limestone when needed, though they have a limited capacity. Bulk spreader trucks and pull type applicators can be obtained from fertilizer and lime dealers for applying lime and fertilizer needs. Test the soil to determine lime and fertilizer needs.

## 5.12 INVASIVE SPECIES

Highly Invasive Species are not allowed for mined land reclamation. The Virginia Department of Conservation and Recreation Invasive Species List is available at <http://www.dcr.virginia.gov/dnh/invlist.pdf>.

## 5.13 TREE PLANTING

Areas for trees should be considered for all factors of multiple-use lands (i.e., wood products, wildlife, recreation, water, aesthetics, and environmental enhancement) when preparing for tree planting. For additional information and assistance, contact your County Extension Agent or District Forester, Virginia Department of Forestry.

---

\* Indicates legumes that should be inoculated (all legume seed should be scarified and inoculated). The correct strain of inoculant should be used to treat the seed at ten times the rate designated on the inoculant bag. For example, if one bag of inoculant treats 50 lbs. of seed per the instructions on the bag, then it is recommended that 10 bags be used to treat 50 lbs. of seed.

## Planting of Seedlings

Even distribution of seedlings over the area can minimize the variability of density, stocking, and species composition. Tree species and their adaptability to various regions of the state are shown in Table 5-3. Unless specifically prepared for tree plantings, mine overburden can be a difficult growing medium, particularly when substances toxic to plants are present, or if soluble salt content is high (see Section 5-4).

Relatively flat areas are ideal for tractor-drawn planting machinery. Approximately 5,000 seedlings can be planted per day per machine, using this method. Slopes are usually hand planted with a planting bar. Five hundred to 800 seedlings per worker per day is possible for an experienced planting crew.

The planting hole should be large enough to allow the seedling roots to spread out and extend downward. The roots must not be planted in the form of a “U”. Soil should be firmly packed around the seedling.

Pine seedlings, such as loblolly or white pine, should be planted at a spacing of 6 x 6 feet and up to 8 x 8 feet. Spacing for other types of trees is shown in Table 5-3. Seedlings, spacing, and population required per acre are as follows:

6 x 6 feet = 1,200

6 x 7 feet = 1,037

6 x 8 feet = 907

7 x 7 feet = 890

8 x 8 feet = 680

## Seedling Care

Seedlings are delivered in bundles of 500 to 2,000. When the seedlings are taken from the bundle for planting, the roots should be kept moist. Do not carry seedlings with the roots exposed. It is essential that the roots of the seedlings not dry out or freeze before planting. The bundles should be stored in a cool, moist, dark area.

## Time of Planting

Seedlings can be planted from December through April. On some sites, spring planting is preferable to winter planting. Some frost heaving may occur in loose material.

## Seedling Sources

Seedlings are available from state and commercial nurseries. Availability from the state nursery depends upon the supply and the demand for seedlings. Seedlings may be ordered from the Virginia Department of Forestry through the County Chief Forest Warden. Unless special arrangements are made, payment for seedlings must accompany the order. Early ordering is recommended.

## Plantation Management

Seedlings should be protected from grazing animals and fire. Technical and educational assistance is available through the Virginia Department of Forestry and the Cooperative Extension Service in all aspects of tree planting and forest management.

**Table 5-3: Types of Trees and Their Adaptability to Various Regions of the State of Virginia**

	Erosion Control Only	Erosion Control and Screening	Screen Only	Erosion Control and Wildlife Habitat	Wildlife Habitat	Erosion Control and Noise Abatement	Noise Abatement	Erosion Control and Timber Production	Timber Production
Loblolly Pine			G <sup>5</sup>		A		E <sup>6</sup>		G <sup>6</sup>
White Pine			E		A		E		E <sup>7, 8</sup>
Shortleaf Pine			A		A		G		A
Virginia Pine	G <sup>1</sup>	E <sup>1</sup>	G	G <sup>1</sup>	G	G <sup>1</sup>	E	E <sup>1</sup>	G
Red pine			E <sup>2</sup>		A	A <sup>2</sup>	E <sup>2</sup>		E <sup>2</sup>
Scotch Pine	G <sup>7</sup>	G <sup>7</sup>	E <sup>7</sup>		A <sup>7</sup>	G <sup>7</sup>	E <sup>7</sup>		E <sup>7, 8</sup>
Pitch Pine	A <sup>2</sup>		G <sup>2</sup>		A <sup>2</sup>	A <sup>2</sup>	A <sup>2</sup>		
Red Cedar	A <sup>1, 3</sup>	E <sup>1, 3</sup>	E <sup>3</sup>	G <sup>1, 3</sup>	G <sup>3</sup>	G <sup>1, 3</sup>	E <sup>3</sup>		3
Norway Spruce			E	A <sup>4</sup>	E <sup>4</sup>				A
Black Locust	E <sup>1</sup>	G <sup>1</sup>	A	G <sup>1</sup>	G	G <sup>1</sup>	A	A <sup>1</sup>	A
Yellow Poplar			A		A		A		A
Ash	A	A	A		G		A		G
Sycamore	A	A	A		A		A		G
Sweet Gum			A		A		A		A
Red Oak									A
Black Walnut					G <sup>5</sup>				G <sup>5</sup>
Sawtooth Oak					G <sup>5</sup>				
Persimmon					G				A
BiColor Lesp	A			A	E	A	A		
Bristly Locust	G <sup>1</sup>	A <sup>1</sup>	A	E <sup>1</sup>	E	A <sup>1</sup>	A		
Spacing Guide	6' x 6'	6' x 6'	7' x 8' <sup>9</sup>	6' x 6'	10' x 10' <sup>10</sup>	6' x 6'	6' x 6' <sup>11</sup>	6' x 6'	7' x 8' <sup>12</sup>

A—Acceptable      G—Good      E—Excellent

<sup>1</sup>A straw mulch should be used in conjunction with tree planting.

<sup>2</sup>Only above 2,000 feet in elevation.

<sup>3</sup>Where pH range is 4.0 to 8.0.

<sup>4</sup>For wildlife cover only.

<sup>5</sup>Only on a site suited for B. Walnut.

<sup>6</sup>Coastal Plain, Piedmont and limited to better sites elsewhere.

<sup>7</sup>Shenandoah Valley and Mountain Areas.

<sup>8</sup>Where Christmas Tree production is the objective.

<sup>9</sup>Minimum of 3 rows, 5 rows preferred, with seedlings staggered with rows.

<sup>10</sup>Except for BiColor Lespedeza, which should be spaced 3' x 3'

<sup>11</sup>A minimum of 100-foot wide strip needed. Where species are mixed, do not mix within rows.

<sup>12</sup>Spacing on white pine 10' x 10', hellow pines 7' x 8', and hardwood 12' x 12'.

Spacing	Seedlings/Acre
3' x 3'	4,840
6' x 6'	1,210
7' x 8'	778
10' x 10'	436
12' x 12'	302

Tree seedlings for the above species can be obtained from the Virginia Department of Forestry.

## **Screening, Noise, and Dust Abatement**

Trees are an effective means of screening mine sites from residential areas and highways. They are also effective for reducing noise pollution and to some extent dust pollution. Evergreens or conifers are best for this purpose as they provide "year-round" foliage cover. It is suggested that DMM Mine Inspectors, local foresters and landscape architects be consulted regarding the varieties of trees to use for a particular screen, type of mining operation, and planting medium.

### **5.14 PLANTINGS FOR WILDLIFE HABITAT**

Mined areas can be effectively managed for wildlife while meeting reclamation standards. The types and numbers of wildlife attracted to these areas will depend on existing wildlife populations and quality of habitat in the vicinity. This will be particularly true for game species such as deer, wild turkey, grouse, dove, rabbits, squirrels, and raccoons. A wide variety of wildlife species can use mined areas and a realistic goal would be to manage for the maximum diversity of wildlife, not just one or two species.

Areas containing the largest variety of plant species and ground forms are capable of supporting the greatest diversity of wildlife. Mined areas can improve the overall wildlife of the region by adding to its diversity. This can be accomplished by the use of a variety of plant species including annuals, perennial grasses and legumes, and woody perennials such as vines, shrubs, and trees. A diverse vegetative cover generally will support a variety of insect life, which is an important food of young birds. If surrounding areas are forested, then mined areas reclaimed to grasses, legumes, low-growing shrubs, annual millets, sorghums and grains are highly beneficial to deer, rabbits, grouse, turkey, and quail.

#### **Annuals**

Annuals complete their life cycle (germination, growth, seed set) in only one growing season. Annuals provide a stable food source for seed-eating forms of wildlife and provide rapid cover. Recommended annuals suitable for mined areas include annual lespedeza, foxtail millet, and grain crops.

#### **Perennial Grasses and Legumes**

In addition to providing erosion control, perennial grasses and legumes provide long-term cover and food source for many forms of wildlife. The seeds and succulent green parts are a favorite food for many birds and small mammals. Legumes are particularly attractive to a variety of wildlife. Recommended perennial grasses and legumes include appallo lespedeza, orchard grass, red and ladino clover, crownvetch, and birdsfoot trefoil.

#### **Woody Perennials**

Woody perennials are a source of food and cover for wildlife, and provide essential habitat for many tree-nesting birds. The nuts, fruits, and seeds of woody plants are excellent sources of food, while dense shrubs and conifers provide excellent cover. Some recommended vines, shrubs, and trees for wildlife include wild grape, bicolor or shrub lespedeza, tartarian honeysuckle, black locust, apples, Japanese honeysuckle, and blackberries.

## Planting Design

The planting design is as important as the selection of plant species. Annual and perennial grasses, and legumes, should be seeded in mixtures according to recommendations listed previously in this guidance. The key to good wildlife management is to keep plantings small and interspersed. Many small irregular shaped patches are better than a few large tracts. Clumps of woody perennials or conifers should be interspersed with the herbaceous vegetation.

Left unmanaged, reclaimed mined areas can become forested areas. The rate of forestation depends upon the soil, climate, drainage, and other environmental factors. As the habitat changes from ground cover to shrubs and finally to forests, there are corresponding changes to wildlife species living in the area. Maximum diversity of habitat can be achieved by interspersing ground cover with shrubs and forested areas. For best results, fragmentation should not be greater than 25 acres.

For more information and assistance, contact County Extension Agents, Natural Resource Conservation Service, and District Wildlife Biologists of the Virginia Department of Game and Inland Fisheries.

### 5.15 VEGETATION OF CRITICAL OR PROBLEM AREAS

Critical areas with inadequate vegetation can be the result of low or high pH values, hard or crusted surface, inadequate lime, fertilization, seeding rate, and/or use of poor quality seed. The first step in working with critical areas is to determine the cause(s) of the failure. A step-by-step procedure is listed below:

- ❖ Soil test to determine lime and fertilizer requirements.
- ❖ Lime and fertilize in accordance with soil test recommendations.
- ❖ Incorporate lime and fertilizer into spoil surface. If trouble spots must be covered with better materials, these materials also must be tested and pH and nutrient problems corrected.
- ❖ Check seeding surface for hardness and crusting. Tracking with a bulldozer, tillage with a heavy disc, or similar type surface scarification can be used to create a more favorable seedbed condition.
- ❖ Check the viability of seed. If deficient, correct by increasing the recommended per acre rate of viable seed, or use new seed that meets specifications.
- ❖ Consider use of non-vegetative stabilization measures as an aid to establish cover.

### 5.16 MULCHES FOR CRITICAL OR PROBLEM AREAS

Mulch should be applied on all critical areas unless the operator can assure that the critical areas can be treated in an alternate way. Minimum application rates should be as follows:

1. **Hay or Straw** should be applied at the rate of one ton per acre with less than ten percent of the soil surface exposed. This type of mulch should be anchored to the seeded surface by spraying with a wood cellulose fiber mulch at the rate of 1,000

- pounds per acre or by crimping with a disc or other suitable equipment. Mulch could also be tied with stakes and string.
2. **Wood cellulose fiber** should be applied by hydro seeder at the rate of 1,500 pounds per acre. It should be color-dyed to provide visual metering of its application.
  3. **Alternate mulches** may be utilized, but must be approved by DMM prior to application.

Appropriate seeding mixtures adapted to the specific region should be used in reseeding critical areas. The required mixture will be determined by the date the area is to be sown. Lime and fertilizer requirements are to be in accordance with lime tests. Seeding rates for critical or problem areas should be increased 100 percent from normal to promote a quick vegetation cover. Also non-vegetative stabilization measures can be used as an aid to establish vegetation cover.

This page intentionally left blank.





## 6 WILDLIFE PLAN

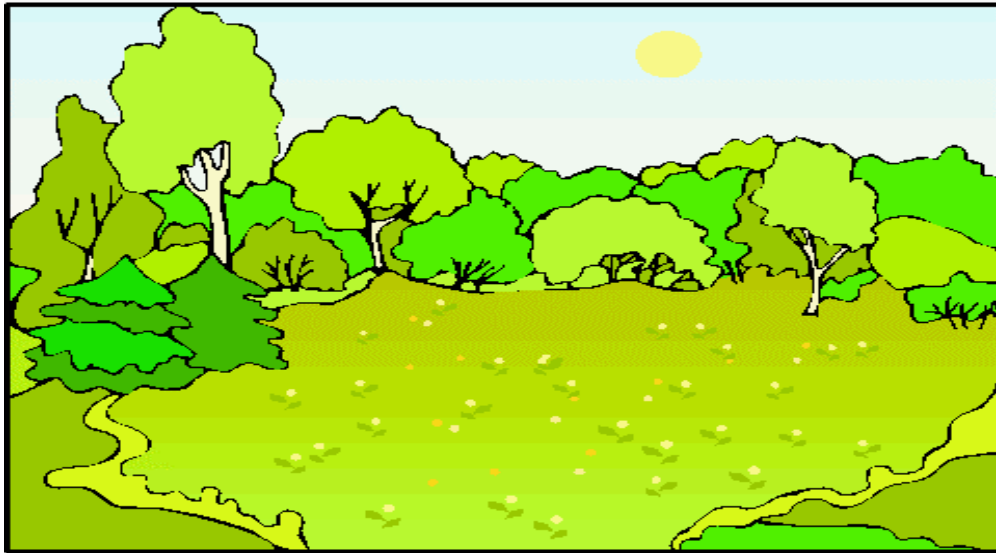

### 6.1 HABITAT REQUIREMENTS

The place where a wildlife species normally lives is called its habitat. Food, cover, water and the interspersed of those essential components are essential to the wildlife species survival and success. These habitat components are briefly discussed here because an understanding of them is imperative in developing a comprehensive wildlife plan.

#### **Food**

The availability of the staple foods for a wildlife species is a critical consideration in developing a wildlife plan. Food supplies must be within the foraging range of the species of interest and available during all seasons. Wildlife diets change with the seasons as the availability of certain foods and the needs of the animals vary. Food sources must be available to resident wildlife in the winter to prevent starvation. Entire plants or various parts of plants may serve as food sources for wildlife.

#### **Cover**

Cover is as critical to wildlife as food. There are different types of cover, all of which may be required by a species. Plants provide brooding and nesting cover, escape cover, and shelter. Although all plants provide a certain degree of cover, some plants are more suitable than others for specific cover needs.

#### **Water**

Requirements for water are met in various ways for different wildlife species. Not all wildlife species require surface water in the form of streams, ponds, seeps, etc. Some species are able to obtain their necessary moisture from the succulent plants they consume, from dew, or from their own metabolic processes. Snow also provides a source of water in the winter.

## Interspersion

Interspersion or the arrangement of food and cover areas within the home range of the species is very important to the success of wildlife populations. Failure of otherwise favorable habitats may occur simply because the arrangement of food patches and cover was not carefully planned.

## 6.2 CHOICE OF VEGETATION

The DMM, in cooperation with the Department of Game and Inland Fisheries, has prepared suggested plantings for use in reclamation, which are also ideal for wildlife enhancement. The attached list includes selected species that are most likely to succeed on mine soils. The purpose for these plantings is to replenish the wildlife food supply, cover, and set the stage for natural succession of growth in the plant community.

The trees and shrubs listed are species recommended based on their high ability to produce wildlife food, mature early, and should grow well on mined areas. Table 6.1 and 6.2 are suggested species of trees, shrubs, grasses, and legumes for use. Other species proposed for use may be approved based on a demonstration of their value to wildlife and suitability to the site.

**Table 6-1: Trees and Shrubs**

Common Name	Scientific Name	Spacing (feet)
Sawtooth Oak	Quercus acutissima	8x8
Bear Oak	Quercus ilicifolia	8x8
European Alder (wet areas)	Alnus glutinosa	8x8
Flowering Crabapple	Malus spp.	10x10
Toringo Crabapple	Malus sieboldii	10x10
Siberian Crabapple	Malus bacca-ta	10x10
Hawthorns	Crataegus	10x10
Eastern White Pine	Pinus strobus	8x8
Virginia Pine (stress areas)	Pinus virginiana	8x8
Eastern Redbud	Cercis candensis	8x8

**Table 6-2: Grasses and Legumes**

Common Name	Scientific Name	Rate/acre
Winter Wheat	Triticum aestivum	25 lbs.
Orchard Grass	Dectylis glomerata	25 lbs.
Buckwheat	Fagopyrum sppl.	25 lbs.
White Dutch Clover	T. repens	10 lbs.
Red Clover	T. pratense	10 lbs.
Foxtail Millet	Setaria italica	10 lbs.

Crown Vetch	Coronilla varia	10 lbs.
-------------	-----------------	---------

Each wildlife plot should be arranged to break up vast open areas and create an edge effect.

### 6.3 CHOICE OF WILDLIFE

All of the Virginia wildlife species cannot be considered in reclamation planning because a newly revegetated site cannot immediately provide all species their respective habitat requirements. In this section, consideration is given primarily to wildlife species that can be supported by habitats provided during the initial stages of revegetation, or by combinations of revegetated mined land and adjacent undisturbed land. For example, species such as ruffed grouse should be considered only if the land adjacent to the mined site is natural forest or woodland. It should also be noted that not all of the wildlife species discussed are widespread throughout Virginia. Therefore, before attempting to develop habitat for some species, such as wild turkey, populations of that species should be present in the vicinity of the mined area.

Reclamation should be directed towards the establishment of habitat that will meet the needs of the wildlife species desired. Habitat requirements may be similar for several species of wildlife, thus leaving a choice during reclamation planning. The wildlife plan may concentrate on providing a suitable habitat for one species in particular, a “featured species”, or may consider favoring several different species. Either way, more species than expected may result, but, through planning, the area can support higher populations of the species desired.

In selecting wildlife and preparing for them, the present and future land use objectives must be considered. If the future use of the land ultimately is to be timber production, revegetation efforts will be directed towards forest development. Wildlife species that benefit from this type of vegetative environment can then be assisted by manipulating the habitat to provide specific requirements. If the mined area is to be reclaimed to farmland, wildlife species that thrive in an agricultural environment can be easily accommodated. In many instances wildlife enhancement may be a secondary benefit to the primary land use without modifying the vegetation plans to any great extent. However, the land may be claimed completely for wildlife, perhaps even for a commercial enterprise. In this case the plant species and landscaping would be planned to provide habitat for wildlife in general, or entirely for the game species to be featured.

Neither the DMM nor the Department of Game and Inland Fisheries are responsible for the stocking of game animals. In order to protect the existing wildlife populations from disease, it is strongly recommended that there be no stocking of game animals, unless specifically approved by the Department of Game and Inland Fisheries.

The planting design is as important as the selection of plant species. Annuals, perennial grasses, and legumes can be seeded in mixtures according to the recommendations listed previously. The key to good wildlife management is to keep plantings small and interspersed. Many small irregularly shaped patches are better than a few large tracts. Clumps of woody perennials or conifers should be interspersed with the herbaceous vegetation.

If unmanaged and given enough time, reclaimed mined areas will eventually return to a natural stand of hardwoods. This process of replacement is called plant succession. The rate at which succession takes place will depend upon the soil, climate, drainage and other environmental factors. As succession proceeds, wildlife habitat will evolve through natural stages, thus noticeable changes will occur in wildlife population. Succession often proceeds at a different rate on different parts of the mine, thus contributing to the natural diversity so important to wildlife.

## 7 DRAINAGE

### 7.1 INTRODUCTION

The key to providing adequate erosion and sediment control is the proper management of flowing water. Water flow over barren, unconsolidated soils will place the soils into suspension and transport them from one location to another. The greater the disturbed area and water flow, the greater the erosion and the quantity of sediment transported.



Erosion and sediment control measures must be designed and constructed according to sound engineering principles adapted to individual cases. Factors such as topography, the size of the watershed, the type of cover over the watershed, weather patterns and the duration of the exposure must all be considered.

A successful sediment control program will consist of two parts:

1. Control runoff to prevent erosion from occurring. When controls are used to minimize the quantity of water flowing over bare ground, the amount of erosion and sediment produced will be decreased. Runoff may be minimized by diverting upland runoff around the disturbance caused by mining and by stabilizing disturbed areas with vegetation, mulch or crushed stone immediately after disturbance.
2. Collect sediment that is the product of erosion. Plans need to be developed and properly implemented to trap sediment laden runoff from disturbed areas before it leaves the disturbed area. Sediment control may be provided by a combination of vegetated filter strips, temporary sediment controls, sediment ditches, traps or ponds.

Guidelines for controlling runoff and providing sediment control are discussed within this section of the manual.

### 7.2 SUBSURFACE DRAIN

#### Definition

A perforated conduit installed beneath the ground to intercept and convey groundwater.

#### Purpose

To prevent the accumulation of groundwater within embankments and other areas where drainage is necessary or inadequate.

## Conditions Where Practice Applies

Subsurface drains may be necessary wherever seepage or wet soil conditions indicate the presence of excessive groundwater. Soils must be permeable, and gravity outlets should be available, in order for an effective drain to be installed.

## Planning Considerations

There are two types of subsurface drains:

Relief drains are utilized to remove surface water or lower the water table. These are normally installed along a slope and drain in the direction of the slope. These may also be referred to as underdrains when installed below fill areas.

Interceptor drains are used to remove water as it seeps down a slope. They are normally installed across a slope and drain to one side. If installed properly, they will help prevent the soil from becoming saturated and subject to failure.

## Design Criteria

### ***Relief Drains***

Relief drains are typically started where springs or wet areas occur and are extended to the toe of the fill where they are provided with a surface outlet. These drains are installed in herringbone or random patterns dependent on the source of groundwater to be collected and drained. (Figure 7-1)

### ***Interceptor Drains***

Interceptor drains should be positioned on the uphill side of slopes where seepage or wet areas are occurring. These drains are run across the slope and are designed to intercept groundwater and drain it to a pipe or surface channel that can convey it safely down the slope. These drains usually consist of a single pipe, or series of parallel pipes, if seepage continues to appear down slope of the original pipe installation. (Figure 7-1)

## Construction Specifications

The trench into which the perforated pipe is placed should be at least 18 inches wide and 24 inches deep. Dimensions for the trench and drainpipe are dependent on the permeability of surrounding soil and the quantity of water that needs to be drained.

The trench should be constructed on a continuous grade of one to two percent. The drain foundation should be stabilized with crushed stone to prevent deformation during the covering process. If soft spots are not stabilized, sags may develop in the drain due to the weight of overlying material.

The trench shall be lined with filter fabric prior to the placement of the pipe and bedding material. Filter cloth should be adequate in width to allow it to be wrapped across the top of the bedding material prior to backfilling the trench. At least 12 inches of overlap should be provided between the ends of sheets.

Figure 7-1: Subsurface Drain Layout

### **SUBSURFACE DRAIN LAYOUT**

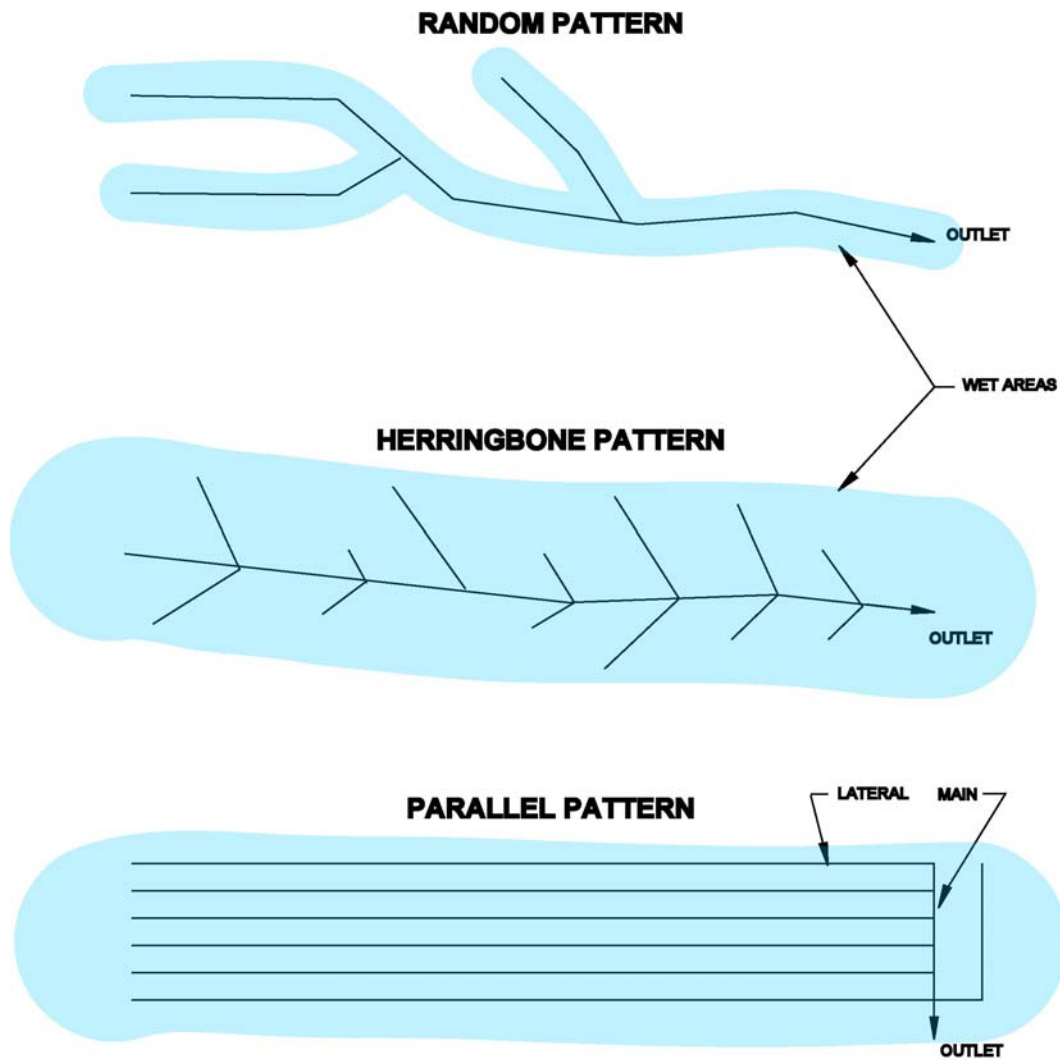

SOURCE: VA Erosion and Sediment Control Handbook, 1992

For permanent drains, install a minimum 6-inch diameter perforated pipe with at least 4 inches of VDOT #68 bedding all around. Install pipe at least 2 feet deep at the bottom of the drain to protect from equipment loading or frost damage. (Figure 7-2) After covering the pipe with 4 inches of bedding material, the filter fabric should be used to cover the bedding and 8 to 12-inches of sand or clean crushed stone (VDOT #9 or #8) should be placed on top of the filter cloth to protect the cloth and facilitate water flow to the drain. Sod or VDOT #1 aggregate should be used to cap the trench.

Manufacturer's specifications shall be used to determine the wall thickness of the drainpipe. Wall thickness shall be sufficient to withstand the bearing weight of soil placed above the pipe and the weight of equipment that may cross the pipe. Deformed or damaged pipe should not be used.

The pipe should be backfilled immediately after placement to prevent damage to the drain from ditch caving or sedimentation.

Drain outlets should consist of solid, un-perforated pipe the last 10 feet of the pipe run. Outlets should be set above water level in any receiving channel or pond. Outlets should extend a sufficient distance beyond the slope to make sure they are not blocked by slides or erosion. They should be protected against the entry of small animals.

Drains should be checked periodically to ensure they are not clogged with sediment or other debris.

Spacing between drains is dependent on the location of seeps or springs, soil permeability and the constructed depth of the drain. Minimum spacing should be 50 feet.

Trees with extensive root systems should be removed within 50 feet of the drains.

## **7.3 BUFFER ZONE**

### **Definition**

A protective strip of vegetation that retards the flow of runoff and causes deposition of transported material.

### **Purpose**

Buffer zones may be used to accomplish the following objectives:

- Serve as a buffer between disturbed and undisturbed areas.
- Decrease runoff quantities to prevent or reduce erosion.
- Improve water quality of receiving streams, or other water bodies, by preventing sedimentation and pollutants from entering the streams.



Figure 7-2: Surface Inlets

## SURFACE INLETS

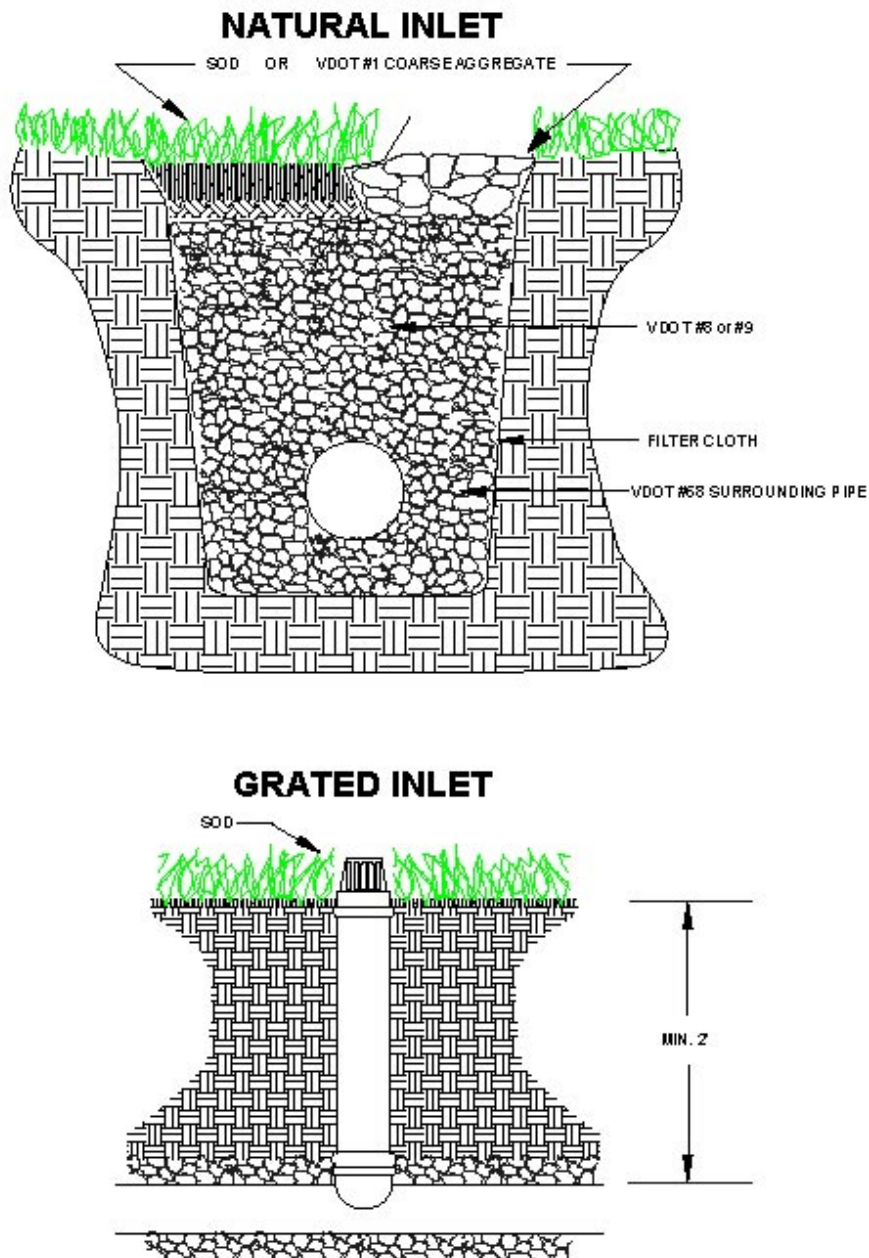

SOURCE: VA Erosion and Sediment Control Handbook, 1992 (Modified by DMM, 2006)

## Conditions Where Practice Applies

This practice applies where:

1. Soil is transported primarily by sheet flow.
2. The buffer zone acts only as a final filter after other sediment control measures have been utilized.
3. Diversions and terraces may need supplemental help to improve their effectiveness.
4. Drainage ditches need protection in order to remain effective for longer periods of time.

## Design Criteria

Table 7-1 is a guide for determining the width of a buffer zone.

**Table 7-1: Buffer Zone Width**

<b>Slope of Land Between Disturbed Area and Area to be Protected (%)</b>	<b>Buffer Zone Width (feet)</b>
0-6	50
7-12	65
13-18	85
19-23	105
24-27	125
28-31	145
32-35	165

## Planning Considerations

A critical factor to determine for an effective buffer zone is the required width. Effective buffer zone widths may vary from 50 feet in relatively well drained flat areas to as much as several hundred feet in steeper, more impermeable areas. Required width is largely a judgmental factor that is determined based on reliable local experience. The following is a partial list of parameters that should be considered in arriving at the width of the required buffer zone.

1. Slope of the land within the buffer zone.
2. Erodibility of the soil within the buffer zone.
3. Amount of runoff that will pass through the buffer zone.
4. Type of vegetation existing, or to be established, in the buffer zone.
5. Land use above the buffer zone.
6. Degree of management that the buffer zone will receive.

## **Buffer Zone Establishment and Maintenance**

If being established, the seed mix must be approved. Vegetation within the buffer zone must be well established, mature, and provide adequate coverage throughout the area. If the buffer zone is going to be mowed, it should only be done during dryer seasons. This will ensure a higher, more efficient vegetative cover during periods of highest rainfall.

## **7.4 PIPE SLOPE DRAIN**

### **Definition**

A rigid or flexible pipe used to convey runoff down a slope.

### **Purpose**

To convey storm water runoff safely down the face of a earthen slope without causing erosion to the slope or the area below the slope.

### **Conditions Where Practice Applies**

Pipe slope drains may be used in place of rock slope drains or paved flumes to transfer runoff from the top to the bottom of a slope. The slopes should be stable, but do not need to have an even surface. (Figure 7-3)

### **Planning Considerations**

There is often a significant lag time in the construction of cut or fill slopes between roughing them in, placing the slope on final grade and establishing a vegetative cover. During this period, the slope is usually not stabilized and is particularly vulnerable to erosion. Pipe slope drains are often the easiest and most economical way to control runoff over these unprotected slopes.

### **Design Criteria**

Pipe slope drains can be used to provide temporary or permanent protection of exposed slopes. It is very important that these structures be installed properly, since their failure will often result in severe slope erosion and sedimentation below the slope. The entrance section must be securely entrenched, all connections must be watertight, and the conduit must be buried or staked securely to prevent it from sliding down the slope and breaking apart.

Slope drains should be located in areas away from future construction that may cause material to be pushed into or over the pipe. Construction traffic should not be routed over a pipe.

### **Drainage Area**

The maximum allowable drainage area per slope drain is 5 acres. Where slope drains are used to drain multiple benches in fill construction, they should be located above one another as additional levels are added to the fill. This will help minimize the erosive effects of flowing water at the discharge end of each pipe and along the benches of the fill.

Figure 7-3: Pipe Slope Drain

# PIPE SLOPE DRAIN

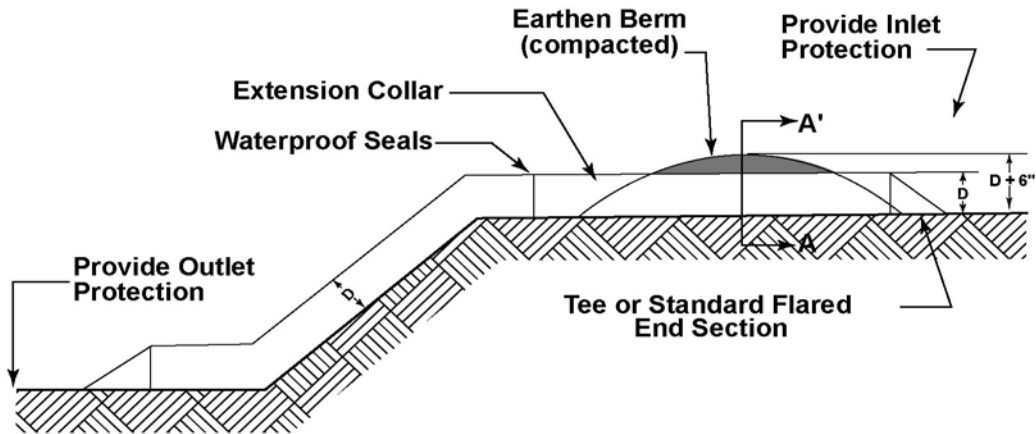

SECTION VIEW

**NOTE:** Sediment may be controlled at outlet if upland ponding will create problems.

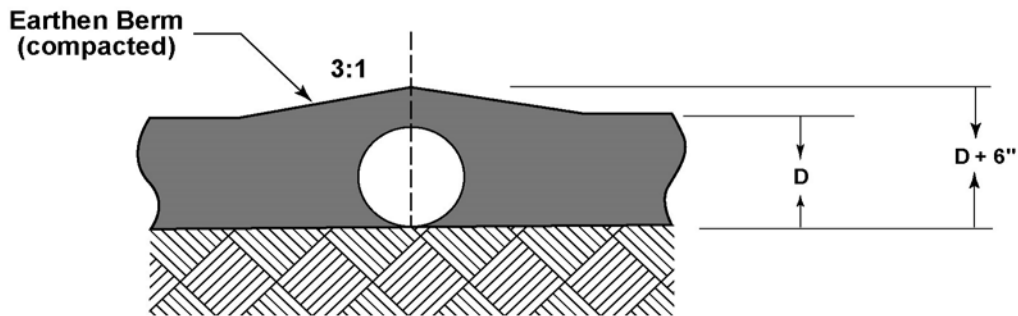

SECTION A - A'

Source: VA Erosion and Sediment Control Handbook, 1992

## Conduit

The pipe shall consist of heavy-duty, flexible or rigid material designed for this purpose. The diameter of the pipe must be consistent over its entire length. All sections of the pipe must be securely fastened together and have watertight fittings. The pipe should be corrugated or provided with reinforced hold-down grommets spaced at maximum 10-foot intervals. Heavy-duty steel stakes of adequate size shall be securely placed on both sides of the pipe within the corrugations or at each grommet. If corrugated pipe is used, the stakes shall be set across from one another and tied to one another with heavy tie wire. The wire ties shall be used to pull the stakes into the pipe corrugations to anchor it and prevent it from sliding down the slope. The conduit shall be placed on undisturbed soil or well-compacted fill. Pipe slope drains shall be sized as noted in Table 7-2.

**Table 7-2: Size Of Pipe Slope Drain**

Maximum Drainage Area (acres)	Minimum Pipe Diameter (inches)
0.5	12
1.5	18
2.5	21
3.5	24
5.0	30

Source: VA. DSWC

## Entrance Sections

The entrance to the slope drain shall consist of a standard VDOT flared end-section or T-section with appropriate inlet protection around the entrance (filter fence and/or filter stone) (refer to Figure 7-4). If ponding will cause a problem at the entrance and make such protection impractical, appropriate sediment-removing measures shall be taken at the outlet of the pipe. If trash accumulation may cause a problem at the entrance, trash racks or rock filter berms shall be installed. The entrance section shall slope toward the slope drain at the minimum rate of ½-inch per foot. Watertight fittings shall be provided at all joints.

## Dike Design

Pipe slope drains must be used in conjunction with berms or diversion dikes to convey runoff from the drainage area above a slope to the inlet end of the drain. The height of the berm at the centerline of the inlet shall be equal to the diameter of the pipe plus 6 inches.

The berm shall cover a width of the pipe equal to twice the diameter of the pipe to ensure a good seal along the pipe. The soil around and under the entrance section shall be hand-tamped in 8-inch lifts to the top of the berm to prevent piping failure around the inlet. The berm shall have 3:1 or flatter side slopes.

Figure 7-4: Flared End-Section

## FLARED END - SECTION

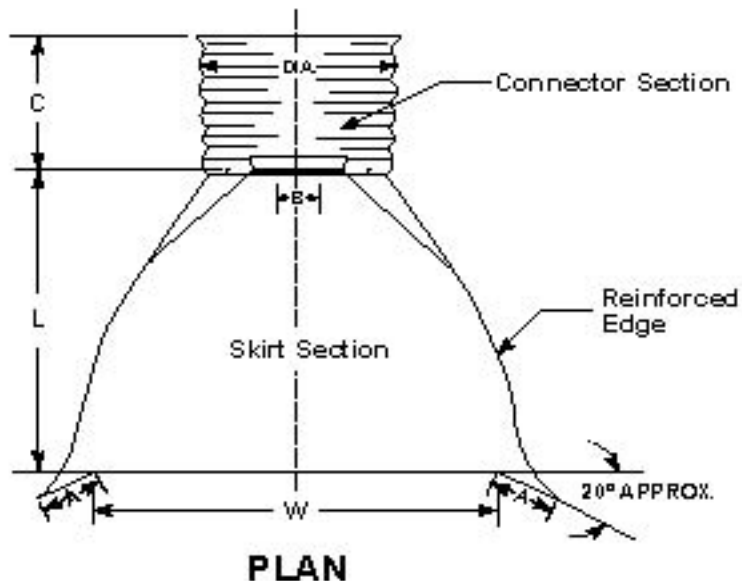

Where flared end-sections are to be used with bituminous coated and paved metal pipe, they are to be galvanized only.

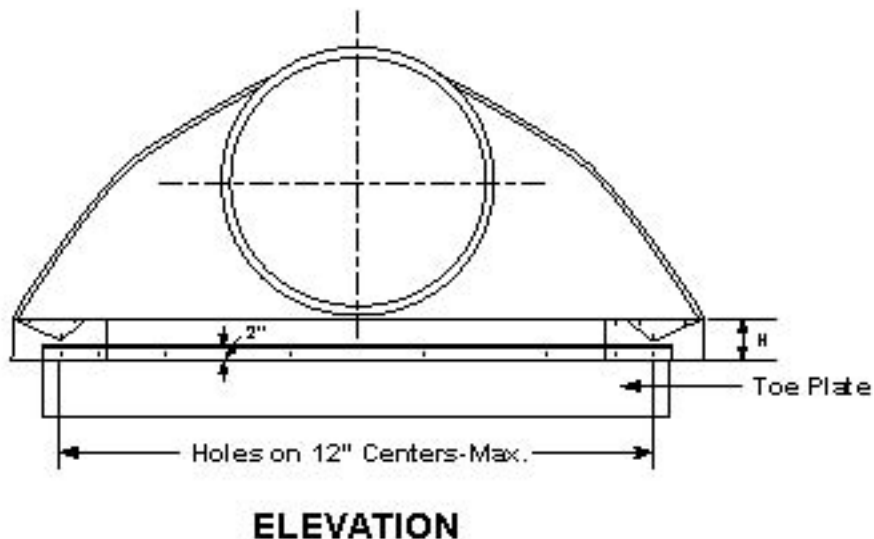

Source: VDOT Road and Bridge Standards

Figure 7-4 (continued)

## FLARED END - SECTION (CONTINUED)

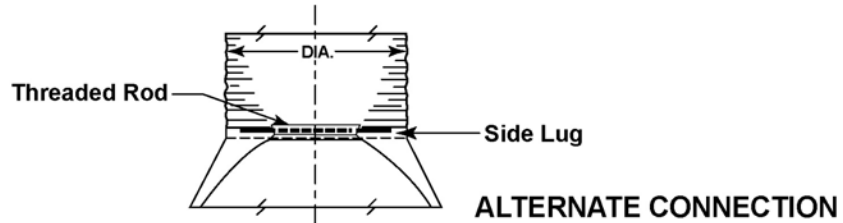

Toe plate, where needed, to be punched to match in skirt up, 3/8" galv. bolts to be furnished. Length of toe plate is  $W + 10"$  for 12" to 30" dia. pipe and  $W + 22"$  for 36" to 60" dia. pipe.

Skirt section for 12" to 30" dia. pipe to be made in one piece.

Skirt section for 36" to 54" dia. pipe may be made from two sheets joined by riveting or bolting on center line. 60" may be constructed in 3 pieces.

Connector section, corner plate and toe plate to be same sheet thickness as skirt.

End-section and fittings are to be galvanized steel or aluminum alloy for use with like pipe.

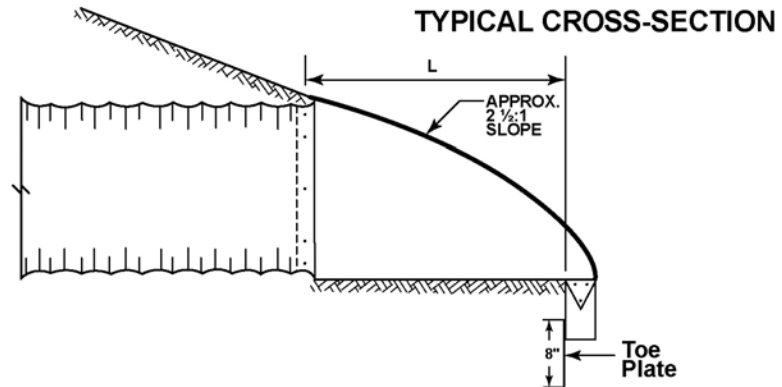

PIPE DIA.	SHEET THICKNESS		DIMENSIONS					
	STEEL	ALUMINUM	A	B	H	L	W	C
			1" TOL.	MAX.	1" TOL.	1 1/2" TOL.	2" TOL.	
12"	.064"	.060"	6"	6"	6"	21"	24"	24"
15"	.064"	.060"	7"	8"	6"	26"	30"	24"
18"	.064"	.060"	8"	10"	6"	31"	36"	24"
21"	.064"	.060"	10"	12"	6"	36"	42"	24"
24"	.064"	.060"	10"	13"	6"	41"	48"	24"
27"/30"	.064"	.075"	12"	15"	8"	51"	60"	24"
38"	.064"	.075"	14"	19"	9"	60"	72"	36"
42"	.064"	.105"	16"	22"	11"	69"	84"	36"
48"	.064"	.105"	18"	27"	12"	78"	90"	24"
54"	.064"/.079"	.105"	18"	30"	12"	84"	102"	36"
60"	.064"/.109"	.105"/.135"	18"	33"	12"	87"	114"	36"

Source: VDOT Road and Bridge Standards

## **Outlet Protection**

The outlet of the slope drain must be protected from erosion. The discharge end of the conduit shall extend at least 4 feet onto flat ground from the toe of the slope. A riprap discharge apron shall be installed below the outlet. This apron shall consist of:

- Class I riprap placed to a depth equal to the pipe diameter
- Length equal to 6 X the pipe diameter
- Width equal to 3 X the diameter.

## **Maintenance**

The slope drain shall be inspected monthly and after each large storm event. Repairs shall be made as necessary.

## **7.5 GEOTEXTILES**

### **Products and Uses**

Geotextiles are available in many different forms. They may be used for a number of purposes such as providing temporary erosion control, constructing drainage systems, providing underlayment for riprap, and stabilizing roadways.

Most geotextiles used on mine sites are non-biodegradable. These include such items as visual fence barriers, silt fences, and geotextiles used for erosion control. Most of these are permeable fabrics that allow water to pass but restrict fine soil particles from passage. These characteristics can be used to prevent the transport of silt from disturbed areas to undisturbed areas, enable underdrains to last longer by preventing soil from filling the voids between rocks, provide resistance to soil erosion under riprap drainage channels and prevent road surfaces from sinking while allowing them to drain. Manufacturers of these products should be consulted to assist in determining the type of geotextile to use in each case and provide installation instructions.

Another geotextile used on mine sites is soil stabilization matting. These mats are used to aid in the establishment of vegetation in areas where air or water movement make it difficult for vegetation to take hold. Slopes, ditchlines and shorelines are some of the areas where these mats may be used. Most soil stabilization mats are made from jute, straw, coconut fiber or other biodegradable materials. More durable mats are also manufactured using nylon fibers or polyethylene. Some mats are available with seed and fertilizer as part of the blanket. All of these mats are woven with a loose weave allowing vegetation to penetrate and entangle itself in the weave while growing through it. Manufacturers of these products should be consulted to assist in determining the type of mat to use in each case and provide installation instructions.

### **Installation of Soil Stabilization Matting**

Non-biodegradable, plastic soil stabilization matting is classified by VDOT as EC-3 matting. This type of matting can be used to stabilize problem slopes (3:1 or steeper) and permanent stormwater conveyance channels. When properly installed within stormwater channels, it



acts with the vegetative root system to form an erosion resistant cover, which resists hydraulic lift and shear forces. The resultant matrix of root growth and matting can withstand a flow velocity up to ten feet/second. Design velocities greater than this will require the use of riprap or pavement for erosion protection.

Soil stabilization matting shall be placed on graded surfaces that are free from dirt clods and rocks larger than one inch in diameter, or any other foreign material that will prevent direct contact with the soil surface. The area below the mat shall be shaped to eliminate abrupt changes in the ground surface that could create voids under the secured mat. Mats shall be started at the top of the channel or slope and unrolled downgrade. They shall be allowed to lie loosely on the soil without being stretched. The upslope ends of the matting shall be buried in anchor slots no less than 12 inches deep. Check slots shall be used in channels to prevent water flow from undermining the material. Mats shall overlap one another by at least 6 inches along their sides and 3 feet at terminal ends. Stakes, staples, or pins shall be used as noted in the following drawings (Figures 7-5, 7-6, 7-7 and 7-8), or as specified by the manufacturer, to secure the mats to the ground. Periodic inspections shall be made after installation to check for erosion and undermining. Any dislocation or failure shall be repaired immediately. If washouts or breakage occur, the matting shall be reinstalled only after the slope or ditch is repaired.

### **Definition**

Sediment basins include ponds or traps that are constructed for the purpose of providing sediment retention and water clarification.

- Excavated basins are constructed in stable or undisturbed ground with little or no embankment to retain water. They must be excavated primarily below ground with an embankment less than or equal to 3 feet in order to be considered an excavated basin.
- Embankment basins are created by the construction of an embankment or dam across a drainageway or low area. Sediment basins shall not be located in perennial streams.
- Temporary basins are those basins that will be removed during, or before, final reclamation of the mine site.
- Permanent basins are those basins that will remain in place after mine operations have been completed.

**Figure 7-5: Stakes, Staples, & Pins for Installation of Treatment – 2 (Soil Stabilization Matting)**

## **STAKES, STAPLES, & PINS FOR INSTALLATION OF TREATMENT - 2 SOIL STABILIZATION MATTING**

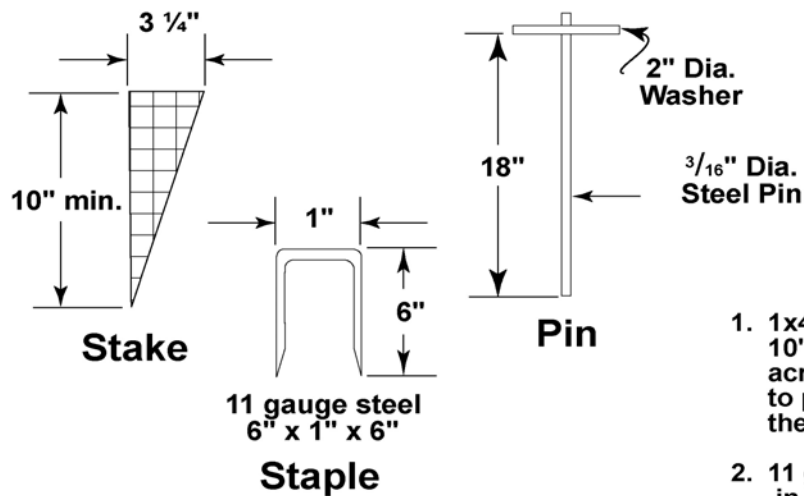

1. 1x4 triangular survey stake - minimum 10" in length. Placement of the stake across the flow of the water is thought to provide a pinball effect to help slow the velocity.
2. 11 gauge steel - minimum 1" wide by 6" in length steel staple - 2" x 8" staple may be required in certain soil conditions.
3. Steel pins - 3/16 diameter steel pin by 18" in length with a 2" diameter washer on top. (See Illustration)

Source: Product literature from Greenstreak, Inc.

**Figure 7-6: General Staple Pattern Guide and Recommendations for Treatment – 2  
(Soil Stabilization Matting)**

**GENERAL STAPLE PATTERN GUIDE AND  
RECOMMENDATIONS FOR TREATMENT-2  
(SOIL STABILIZATION MATTING)**

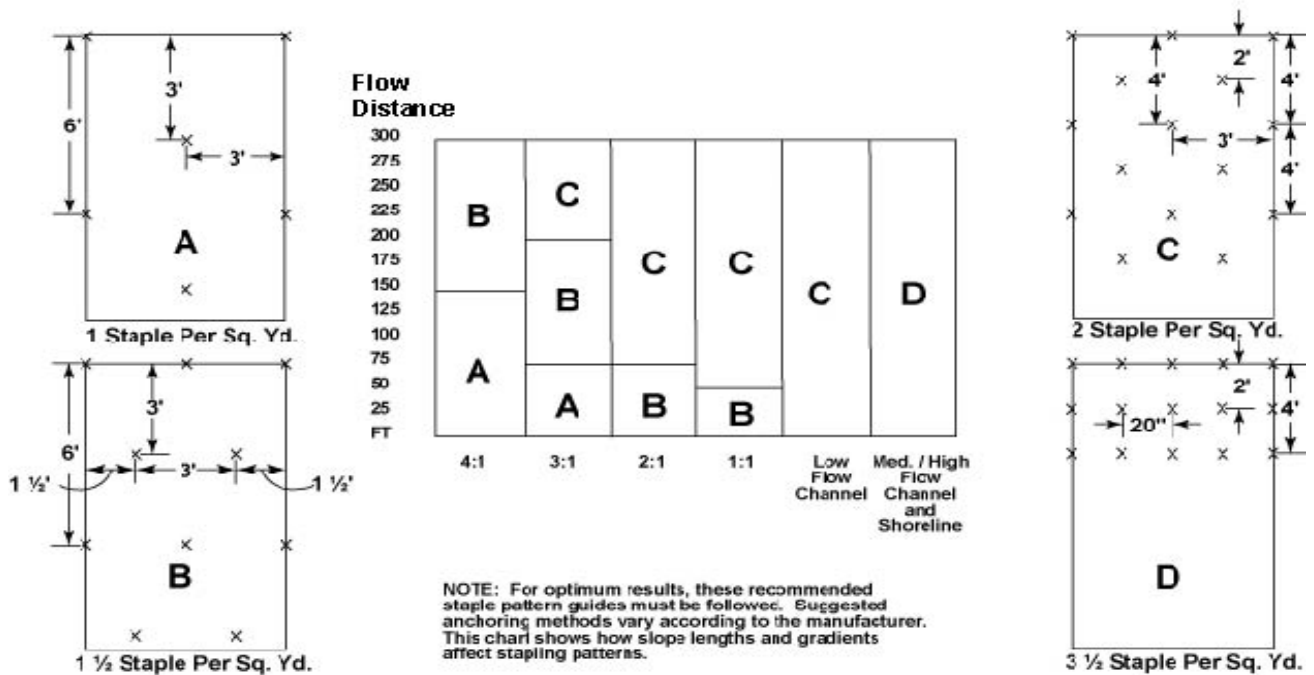

Source: Product Literature from North American Green

Figure 7-7: Typical Treatment – 2 Soil Stabilization Matting Installation

## TYPICAL TREATMENT - 2 SOIL STABILIZATION MATTING INSTALLATION

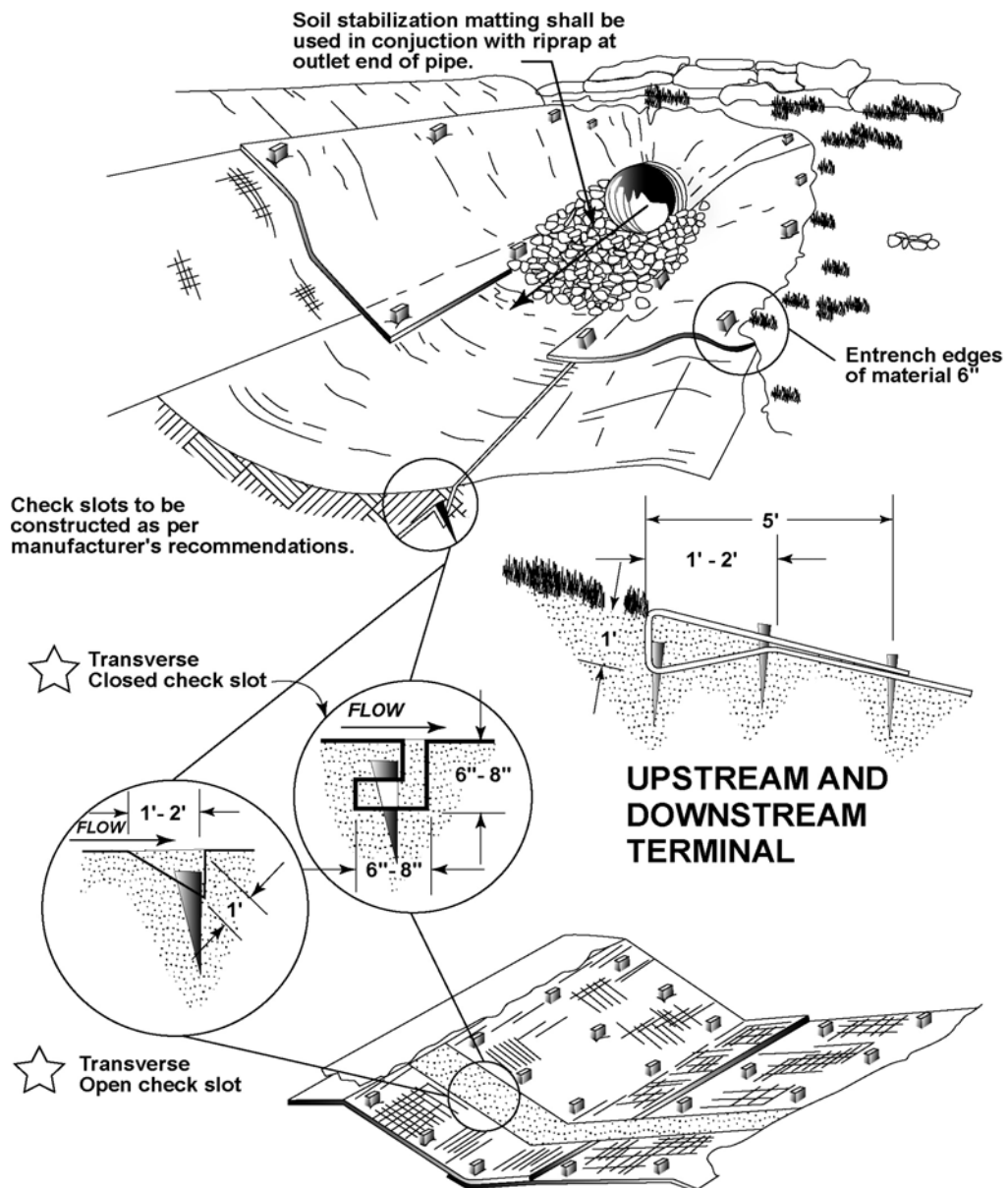

Source: VDOT Road and Bridge Standards

Figure 7-8: Typical Treatment – 2 (Soil Stabilization Matting Slope Installation)

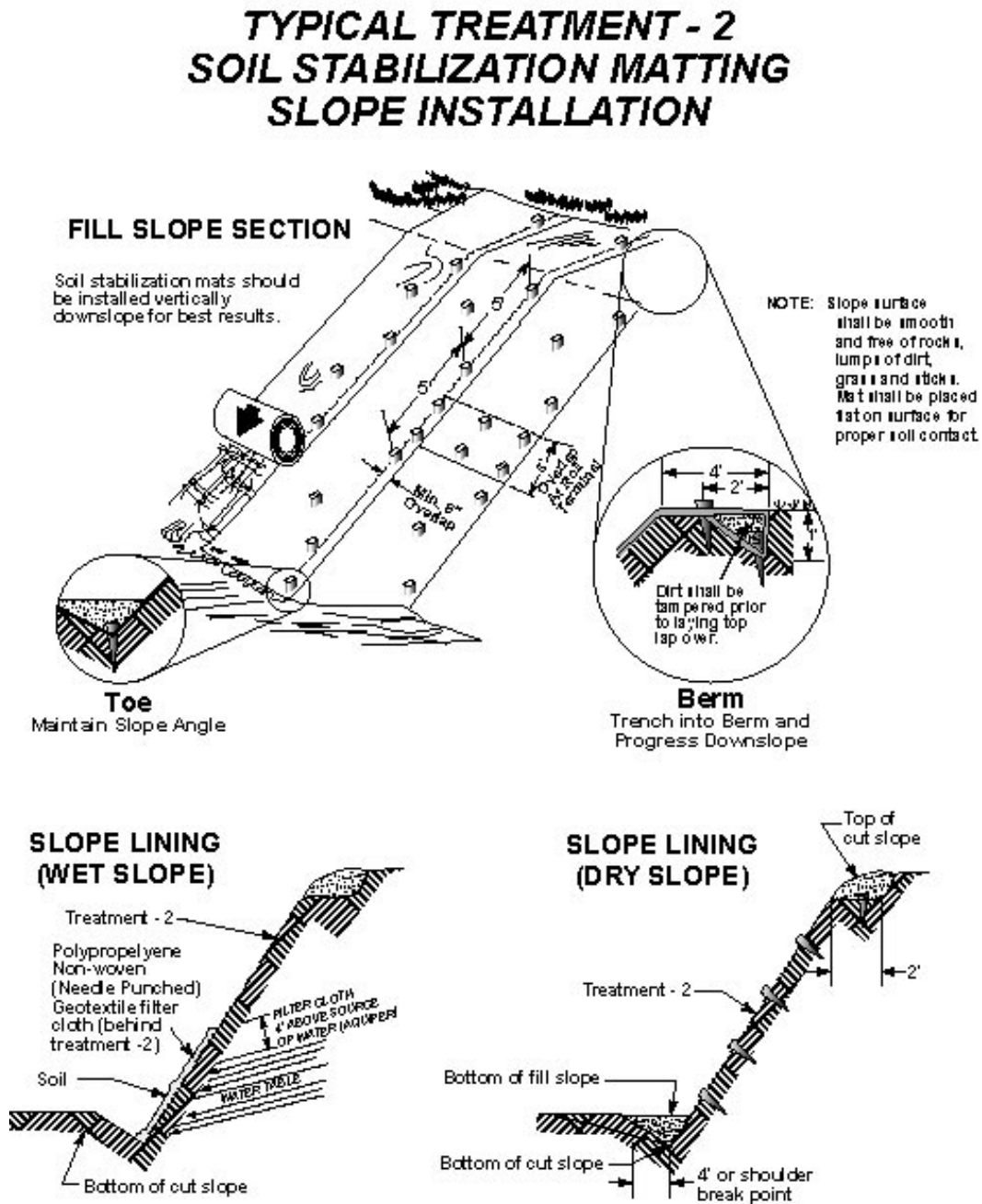

Source: VDOT Road and Bridge Standards

## 7.6 SEDIMENT BASINS

### Purpose

Sediment basins are used to control runoff, trap sediment and clarify water prior to discharge from the mine site.

### Conditions Where Practice Applies

Sediment basins shall be used in critical areas where steep slopes, easily erodible material, heavy equipment traffic, hostile growing conditions, concentrated drainage or other difficult situations exist that may increase the quantity of runoff and transported sediment. Sediment basins should be used wherever large areas are disturbed or long-term impacts are present. Properly designed and maintained basins are very effective in handling heavy water flow and trapping heavy sediment loads. Sediment basins may be used in combination with other sediment control measures and should remain in place until the sediment producing area is permanently stabilized.

### Design Criteria for Sediment Basins—Compliance with Laws and Regulations

Design and construction shall comply with State and local laws, ordinances, rules, and regulations. Combination, excavated and embankment ponds, shall comply with the specifications of embankment ponds, if the embankment is over 3 feet in height.

### Location

The following considerations should be taken into account when choosing a location for an embankment sediment basin:

- ◆ The ground should be stable and suitable for construction of the embankment.
- ◆ The embankment should be located in an area where it will impound the greatest volume at the lowest height.
- ◆ Access should be available to the embankment, decant structures, and pool for maintenance and clean-out.
- ◆ The embankment should not be constructed across a perennial stream.

### Storage volume

The purpose of all sediment basins is to capture and slow down flowing water. Reducing the velocity of flowing water allows the sediment carried by the water to drop out. All sediment basins shall have a volume, below the discharge point, of at least 0.125 acre-feet for each acre of disturbed area draining into the basin. An acre-foot is equivalent to a one acre area, one foot deep.

$$1 \text{ ac-ft} = 43,560 \text{ ft}^3$$

$$0.125 \text{ acre-feet/acre} = 5,445 \text{ cubic feet/acre} = 201.67 \text{ cubic yards/acre}$$

It is important to maintain this volume during the life of the structure. Generally, the greater the volume within the structure, the slower water will flow thru it and the more sediment will drop out. The length of time that water stays within the basin is called retention time. Retention time can be maximized by constructing the basin such that the inlet and outlet are as far away from each other as possible and by regularly cleaning out accumulated sediment.

### **Clean out**

By regulation, sediment basins shall be cleaned out when sediment accumulations reach 60 percent of the design capacity. The construction drawings must indicate the corresponding 60 percent cleanout elevation. A field-reference benchmark must be established for future determination of the 60 percent cleanout requirements.

### **Structure in Series or Parallel**

When site topography or other physical restraints restrict the available area or storage capacity needed for construction of a basin, smaller structures may be built in series or parallel (refer to Figure 7-9).

Basins are often constructed in series when construction of one large basin becomes impractical. An example of this would be constructing several small basins in series at the base of a narrow valley. When basins are constructed in series, the sum of their volumes should equal the total volume necessary for the disturbed area they are treating. The discharge capacity of each spillway in the series should be capable of handling runoff from the total drainage area above the structures.

Basins are often constructed in parallel when it becomes desirable to decrease the size of the watersheds above the basins. An example of this would be constructing several basins along the lower perimeter of a watershed and using diversions to divide the watershed between the basins. When basins are constructed in parallel, each basin and spillway is individually designed based on the size of the disturbed area and watershed above the basin.

### **Outlet Facilities**

Most sediment basins are constructed with outlets consisting of both pipe and open channel spillways. (Figure 7-10) When used together, these are sometimes referred to as principal and emergency spillways. Together, or by themselves, these spillways should be capable of safely passing the peak runoff from the entire watershed above the basin for the design storm. The spillways should be capable of preventing the embankment from being overtopped and eroded. The combined capacities of the pipe and open channel spillways may be utilized to accomplish this requirement. Temporary basins shall have outlets capable of safely passing the peak runoff from a 50-year frequency storm. Permanent basins shall be constructed with an open channel spillway capable of safely passing the peak runoff from a 100-year frequency storm. Runoff computations shall be based upon the worst-case ground cover conditions anticipated within the watershed above the basin.

**Figure 7.9: Sediment Basins in Series and Parallel**

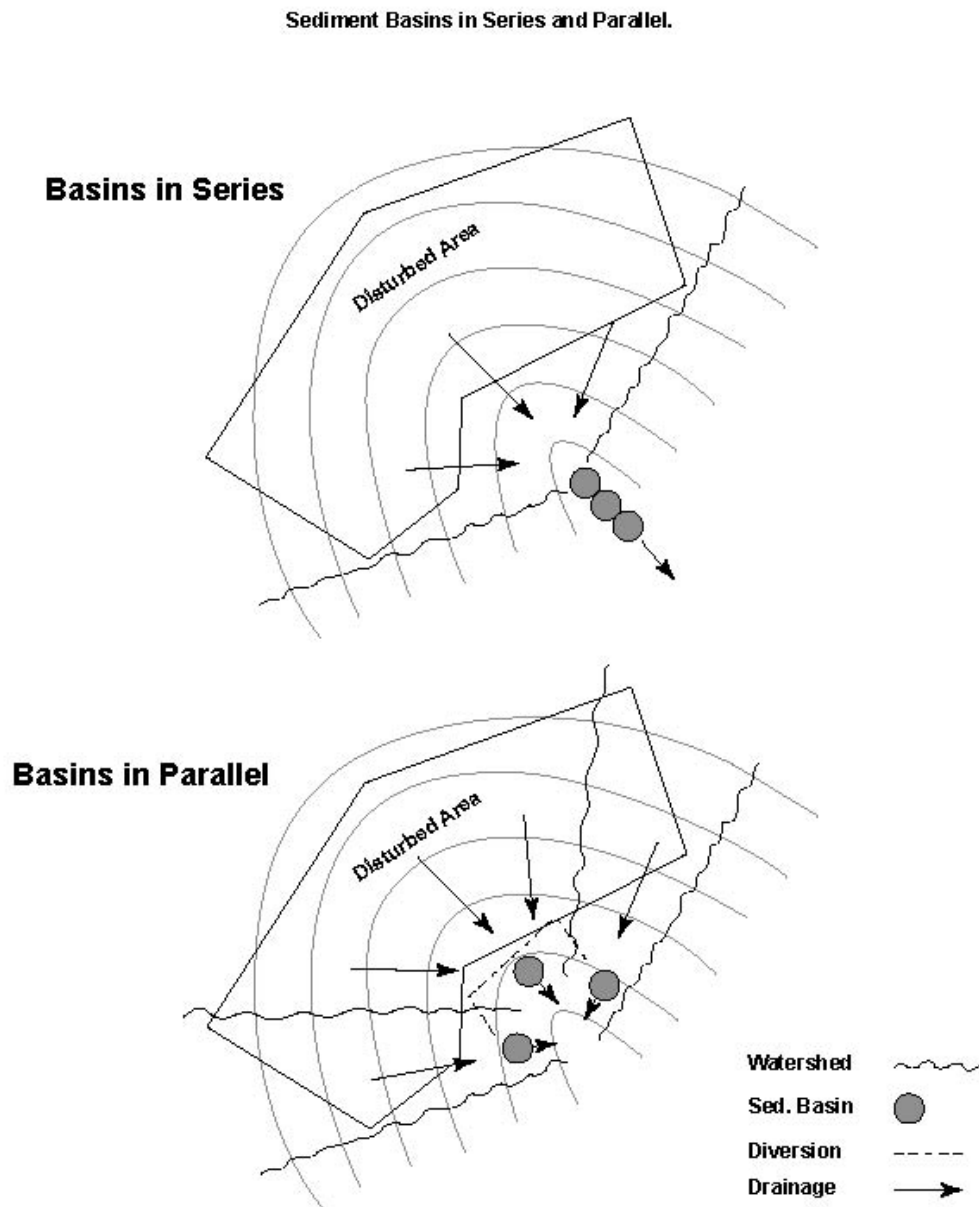
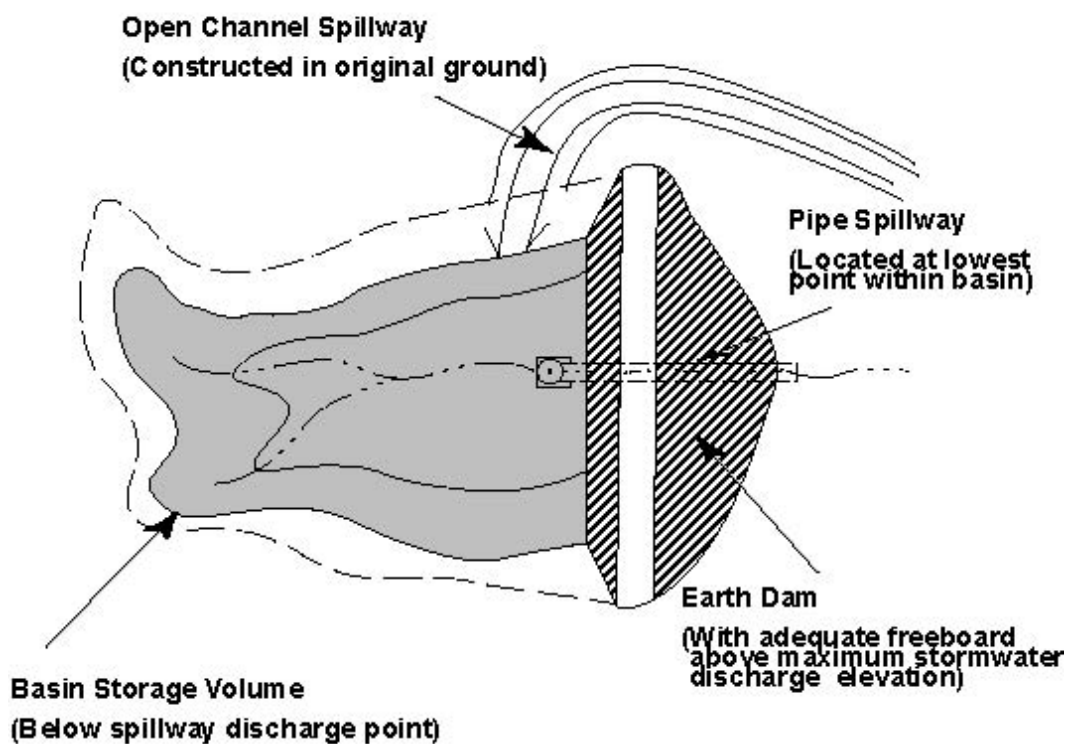



Figure 7-10. Typical Sediment Basin

**TYPICAL SEDIMENT BASIN**



The spillway must be set at or above the design volume of the basin. In other words, the basin needs to provide the required storage volume below the base of the decant structure.

If a decant pipe is used, the riser should be at least 18 inches in diameter and the barrel at least 12 inches in diameter. If an open channel spillway is used, it should be at least 8 feet wide as measured perpendicular to the direction of flow.

### **Pipe Spillways**

A pipe spillway normally consists of a decant pipe or box type riser joined with watertight connections to a barrel pipe, which extends through the embankment and discharges beyond the downstream toe of the dam. Sometimes the riser is perforated to provide for a gradual draw down after each storm event.

At a minimum, the size of the riser pipe should be 18 inches in diameter and the size of the barrel pipe should be 12 inches in diameter.

### **Open Channel Spillways**

An attempt should be made with all embankment type sediment basins to install an open channel spillway. The open channel spillway is less susceptible to damage and plugging and, with proper maintenance, should ensure that storm water entering the basin is safely discharged even if damage occurs to the pipe spillway.

The open channel spillway should be a trapezoidal channel constructed adjacent to the embankment in undisturbed material (original ground). The spillway shall be lined with riprap placed on filter cloth or a bed of granular materials. It may also be paved with concrete or asphalt. The completed open channel spillway cross section should be trapezoidal with a minimum bottom width of 8 feet. Where possible, the control section, or level portion of the spillway adjacent to the embankment, should be at least 20 feet in length. Discharge velocities shall be within the allowable safe range for the type of erosion protection used. (Graphs 7-1 and 7-2) (Tables 7-3 and 7-4)

### **Freeboard**

Freeboard is the difference between the design head over the spillway and the top of the settled embankment. Design head is the depth of water flowing thru the spillway during the design storm.

A minimum of 1 foot of freeboard shall be maintained between the design head flowing thru an open channel spillway and the top of an embankment. (Figure 7-11)

When used in combination with open channel spillways, the top of a pipe spillway shall be 1 foot below the base of the completed open channel spillway. (Figure 7-12)

If no open channel spillway is used, the top of the pipe spillway shall be set at least 3 feet below the top of the embankment and at least 2 feet of freeboard shall be maintained between the design head entering the pipe and the top of the embankment. (Figure 7-12)

**Graph 7-1: Comparison of Maximum Flow Rate Versus Slope for Various Channel Linings**

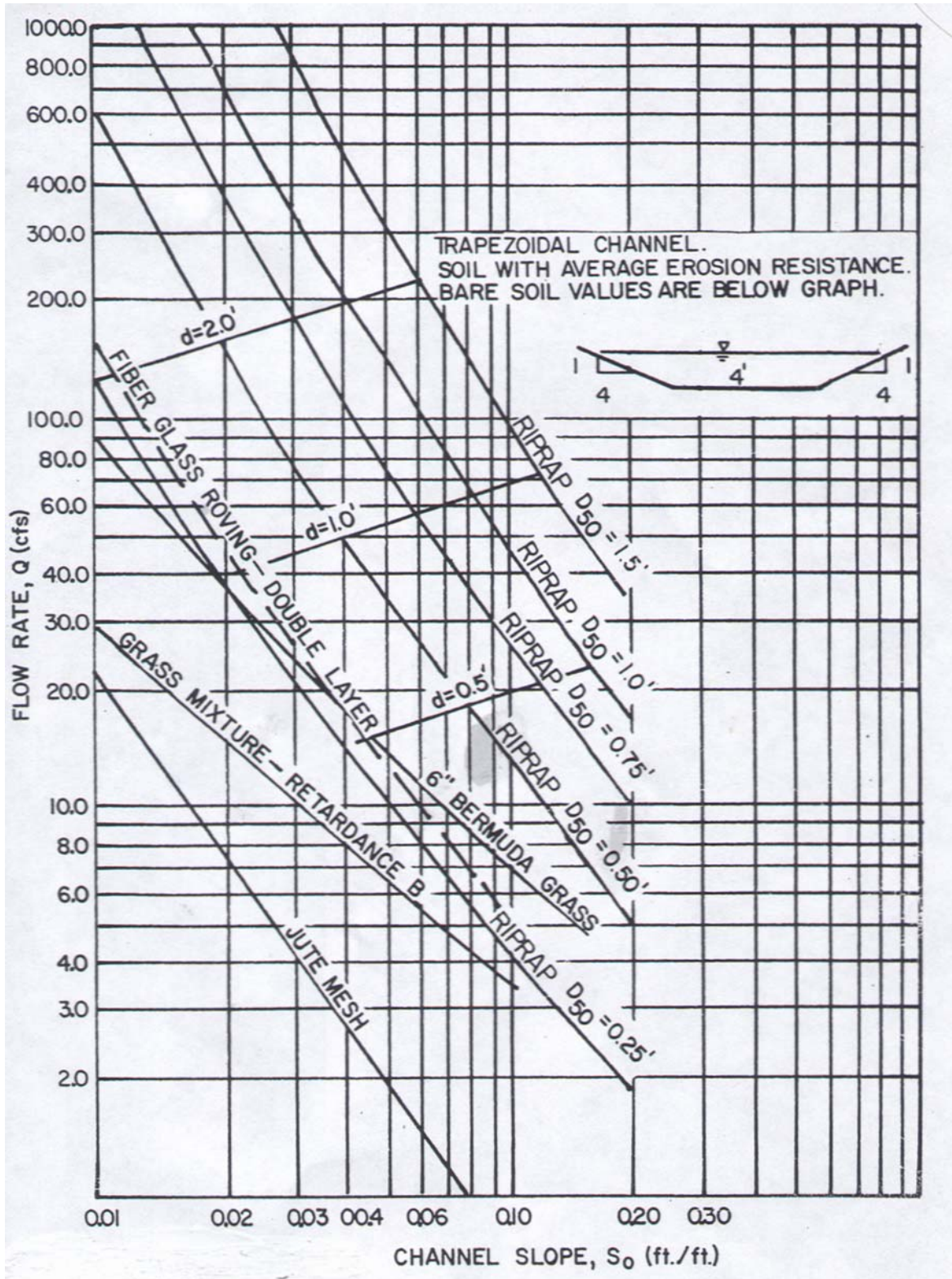

Source: Open Channel Hydraulics

**Graph 7-2: Maximum Depth of Flow for Riprap Lined Channels**

**MAXIMUM DEPTH OF FLOW FOR RIPRAP LINED CHANNELS**

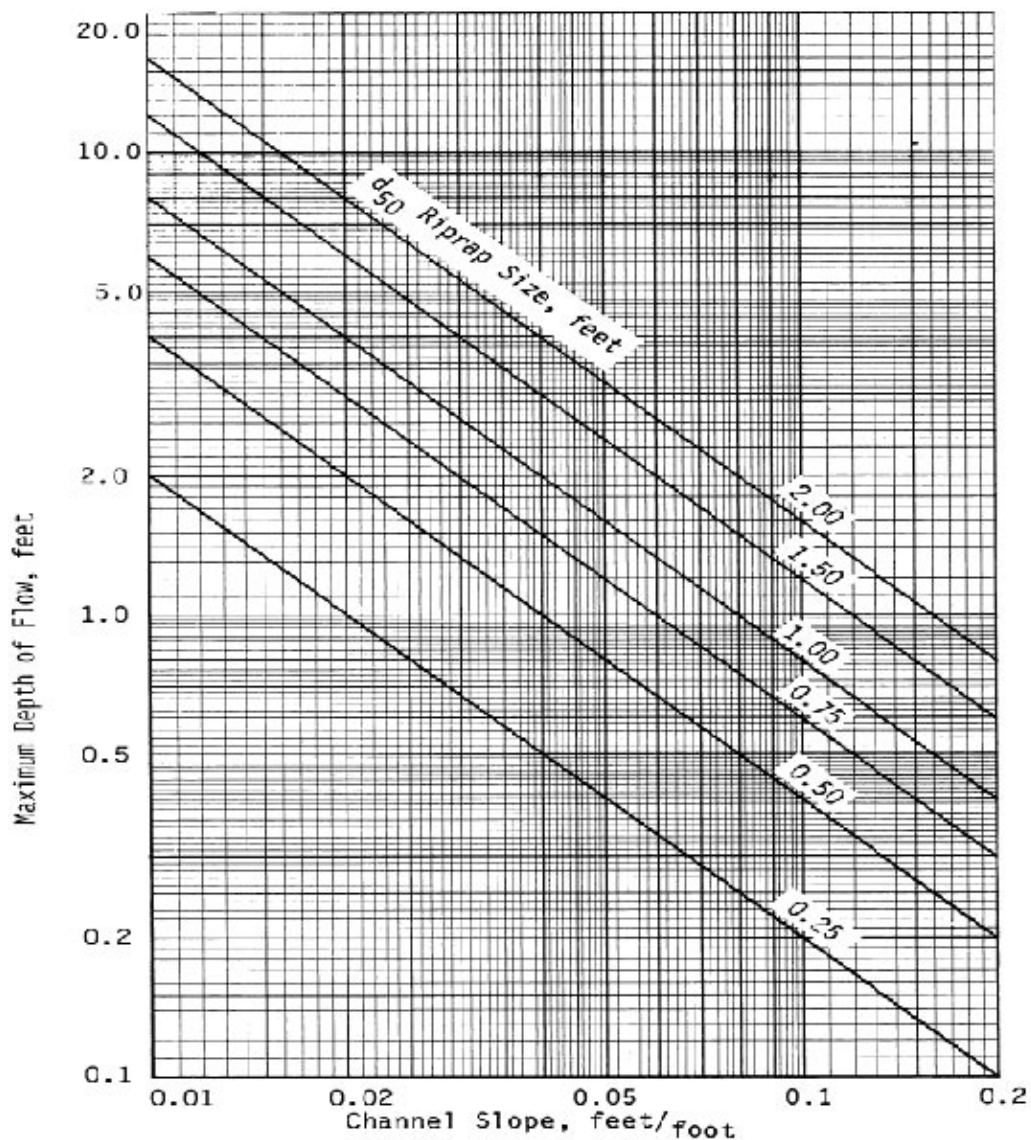

Source: VA Erosion and Sediment Control Handbook, 1992

**Table 7-3: Permissible Velocities for Grass-Lined Channels**

<b>Channel Slope</b>	<b>Lining</b>	<b>Velocity * (ft/sec)</b>
0-0.5%	Bermuda grass	6
	Reed canarygrass Tall fescue Kentucky bluegrass	5
	Grass-legume mixture	4
	Red fescue Redtop Sericea lespedeza Annual lespedeza Small grains Temporary vegetation	2.5
5-10%	Bermuda grass	5
	Reed canarygrass Tall fescue Kentucky bluegrass	4
	Grass-legume mixture	3
Greater than 10%	Bermuda grass	4
	Reed canarygrass Tall fescue Kentucky bluegrass	3

\* for highly erodible soils, decrease permissible velocities by 25%

**Table 7-4: Permissible Velocities for Earth Linings**

<b>Soil Types</b>	<b>Permissible Velocities (ft/sec)</b>
Fine Sand (noncolloidal)	2.5
Sandy Loam (noncolloidal)	2.5
Silt Loam (noncolloidal)	3.0
Ordinary Firm Loam	3.5
Fine Gravel	5.0
Stiff Clay (very colloidal)	5.0
Graded, Loam to Cobbles (noncolloidal)	5.0
Graded, Silt to Cobbles (colloidal)	5.5
Alluvial Silts (noncolloidal)	5.5
Alluvial Silts (colloidal)	5.0
Coarse Gravel (noncolloidal)	6.0
Cobbles and Shingles	5.5
Shales and Hard Pans	6.0

**Figure 7-11: Outlet Design Details (Open Channel Spillway)**

Outlet Design Details  
(Open Channel Spillway)

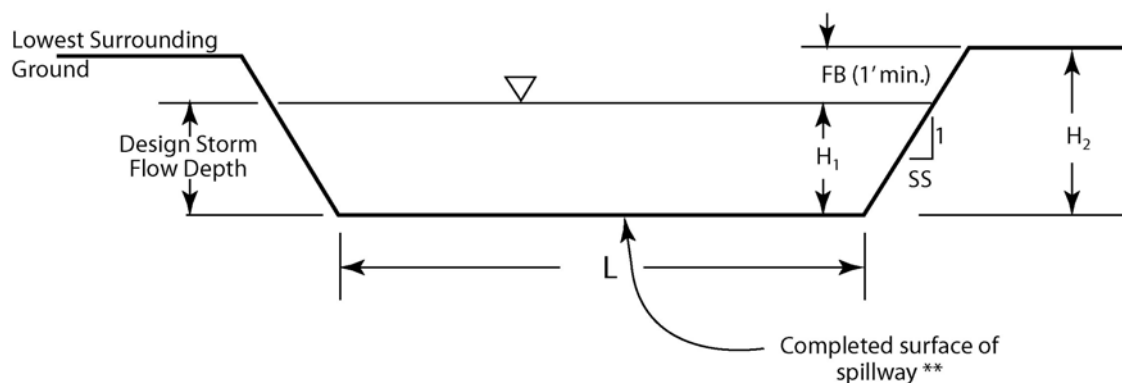

$$H_2 = H_1 + FB$$

\*\* Erosion Protection: Proper erosion protection must be applied to the base and sides of the spillway. In most cases, riprap is used but grass, grass reinforced with geotextiles or concrete pavement may also be used. In most cases, grass lined channels should not be used where flow velocities will exceed 5 ft./second. The use of geotextiles, or soil stabilization blankets, may allow grass lined channels to withstand flow velocities up to 10 ft./second. Properly sized and placed riprap will handle much higher velocities. All forms of protection should be inspected on a regular basis and repaired as necessary.

**Figure 7-12: Outlet Design Details (Pipe Spillway)**

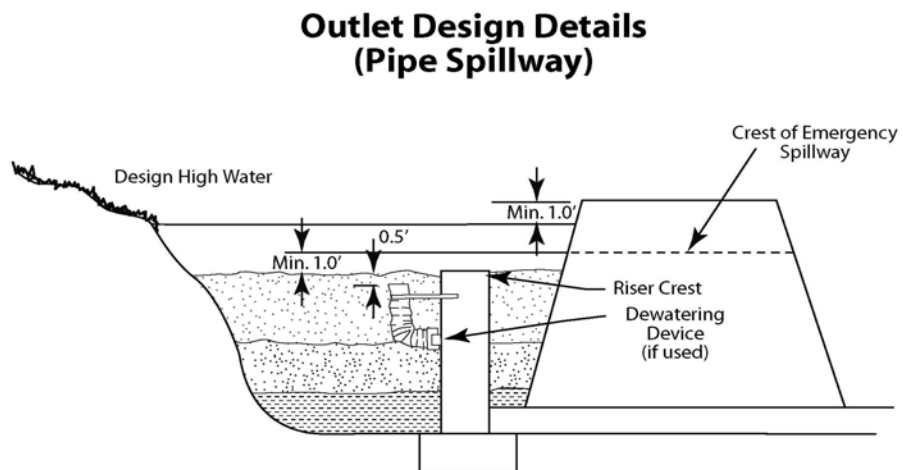

Design Elevations with  
Emergency Spillway

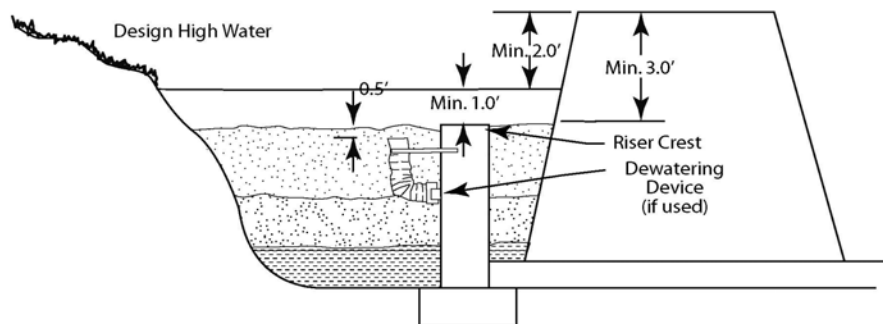

Design Elevations without  
Emergency Spillway



### **Perforated Riser**

The upper half of the sediment basin pool may be drained by using a perforated riser or by some other means. Partial draw down, in preparation for the next storm event, can actually improve the basin's ability to remove sediment. However, only "cleaner" water in the top half of the basin should be drawn off. Therefore, perforations should never extend below the upper half of the riser pipe. Risers should not be perforated with holes greater than 1/2-inch in diameter. In most cases, perforations are spaced 8 inches vertically and 10-12 inches horizontally around the pipe. Perforations should be wrapped in filter fabric resistant to UV light. Filter stone placed around the riser can also be used, with the filter fabric, to provide additional filtering capacity.

### **Anti-vortex Device and Trash Rack**

An anti-vortex device and trash rack shall be securely installed on top of all risers. Anti-vortex devices may be of the plate type or concentric type. The plate type consists of a rigid vertical plate firmly attached to the riser pipe and oriented perpendicular to the centerline of the dam. The plate dimensions shall be: length = diameter of riser + 12 inches; height = diameter of the barrel. The plate type anti-vortex device shall be installed with a trash rack as illustrated in Figure 7-13.

The concentric type trash rack and anti-vortex device consists of a cylindrical cap, larger in diameter than the riser pipe, which is placed over the top of the riser. The cylindrical trash rack also functions as a skimmer in the event that oil is spilled into the basin. The skimmer will prevent oil, floating on top of the water, from entering the top of the riser pipe. See Figure 7-14 and Table 7-5 for construction specifications.

### **Base**

The bottom of the riser shall be located at the low point in the basin to allow complete drainage if necessary. The riser shall have a base attached with a watertight connection and shall have sufficient weight to prevent flotation of the riser. (Figure 7-15) Two approved bases are: (1) a reinforced concrete base at least 18 inches thick with the riser embedded at least 6 inches in the base; (2) a 1/4-inch minimum thickness steel plate attached to the base of the riser with a continuous, watertight weld. The plate shall have 24 inches of stone, gravel, or tamped earth placed on it to prevent flotation. In either case, each side of the square base shall be twice the riser diameter. If a concrete riser is used, then the weight of the concrete in the riser shall be greater than the weight of the water displaced by the riser. If this cannot be achieved, then one of the two anchoring methods described above shall be used.

### **Anti-seep Collars**

Anti-seep collars shall be installed around the barrel pipe, within the normal saturation zone of the embankment. Anti-seep collars shall be adequately sized to increase the seepage length by at least 10 percent when either of the following conditions exists:

- ◇ The settled height of the dam exceeds 10 feet.

**Figure 7-13: Detail of Trash Rack and Anti-Vortex Device**

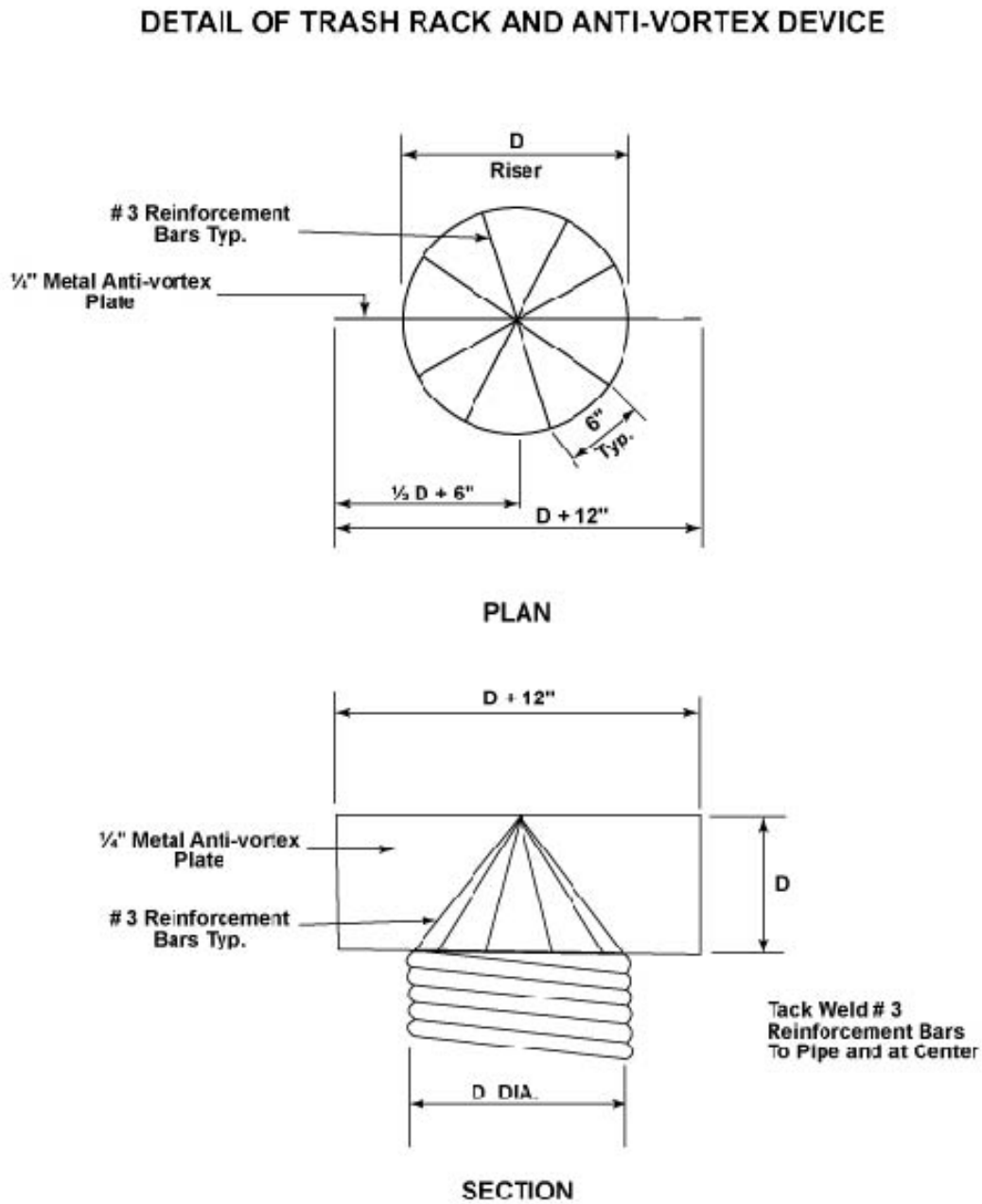

**Figure 7-14: Details of Concentric Cover Trash Rack and Anti-Vortex Device**

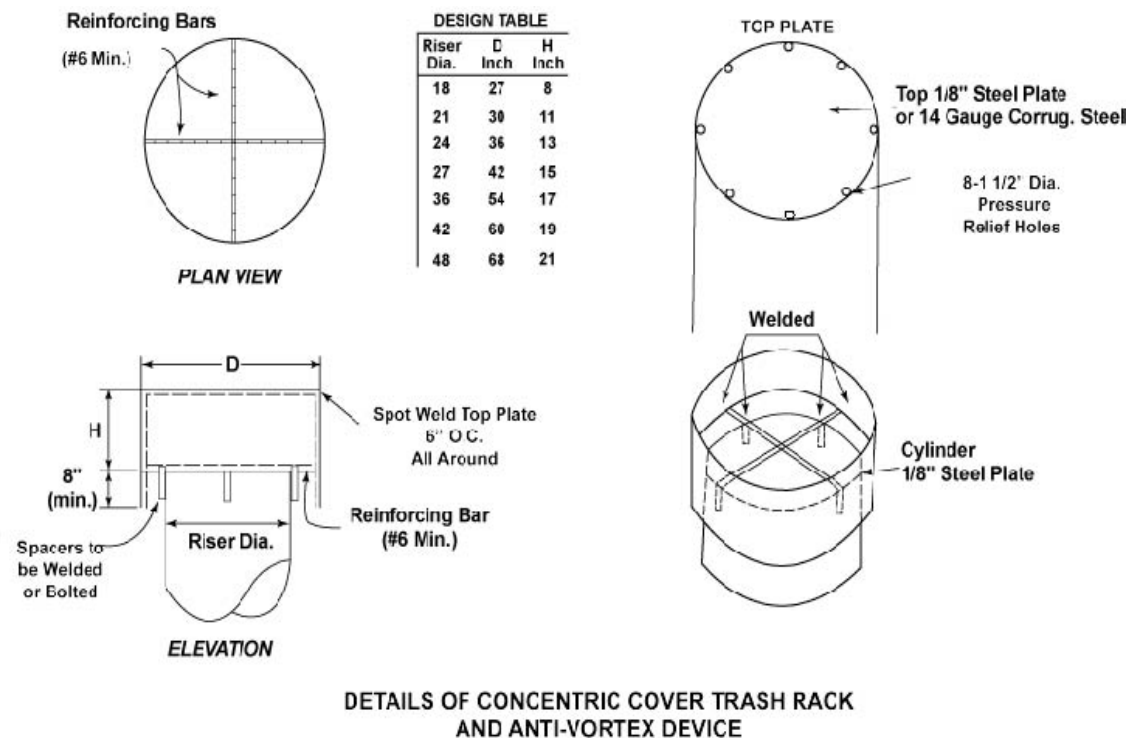

**Table 7-5: Concentric Track Rack and Anti-Vortex Device Design**

Riser Diameter (inches)	Cylinder		Height (inches)	Minimum Size Support Bar	Minimum Top	
	Diameter (inches)	Thickness (gage)			Thickness	Stiffener
12	18	16	6	#6 Rebar or 1 1/2 x 1 1/2 x 3/16 angle	16 ga. (F&C)	–
15	21	16	7	“ “	“ “	–
18	27	16	8	“ “	“ “	–
21	30	16	11	“ “	16 ga. (C), 14 ga. (F)	–
24	36	16	13	“ “	“ “	–
27	42	16	15	“ “	“ “	–
36	54	14	17	#8 Rebar	14 ga. (C), 12 ga. (F)	–
42	60	16	19	“ “	“ “	–
48	72	16	21	1 1/4 pipe or 1 1/4 x 1 1/4 x 1/4 angle	14 ga. (C), 10 ga. (F)	–
54	78	16	25	“ “	“ “	–
60	90	14	29	1 1/2” pipe or 1 1/2 x 1 1/2 x 1/4 angle	12 ga. (C), 8 ga. (F)	–
66	96	14	33	2” pipe or 2 x 2 x 3/16 angle	12 ga. (C), 8 ga. (F) w/stiffener	2 x 2 x 1/4 angle
72	102	14	36	“ “	“ “	2 1/2 x 2 1/2 x 1/4 angle
78	114	14	39	2 1/2” pipe or 2 x 2 x 1/4 angle	“ “	“ “
84	120	12	42	2 1/2 “ pipe or 2 1/2 x 2 1/2 x 1/4 angle	“ “	2 1/2 x 2 1/2 x 5/16 angle

**Note<sub>1</sub>:** The criterion for sizing the cylinder is that the area between the inside of the cylinder and the outside of the riser is equal to or greater than the area inside the riser. Therefore, the above table is invalid for use with concrete pipe risers.

**Note<sub>2</sub>:** Corrugation for 12”-36” pipe measures 2 2/3” x 1/2”; for 42”-84” the corrugation measures 5” x 1” or 8” x 1”.

**Note<sub>3</sub>:** C = corrugated; F = flat.

Figure 7-15: Riser Pipe Base Conditions

## RISER PIPE BASE CONDITIONS

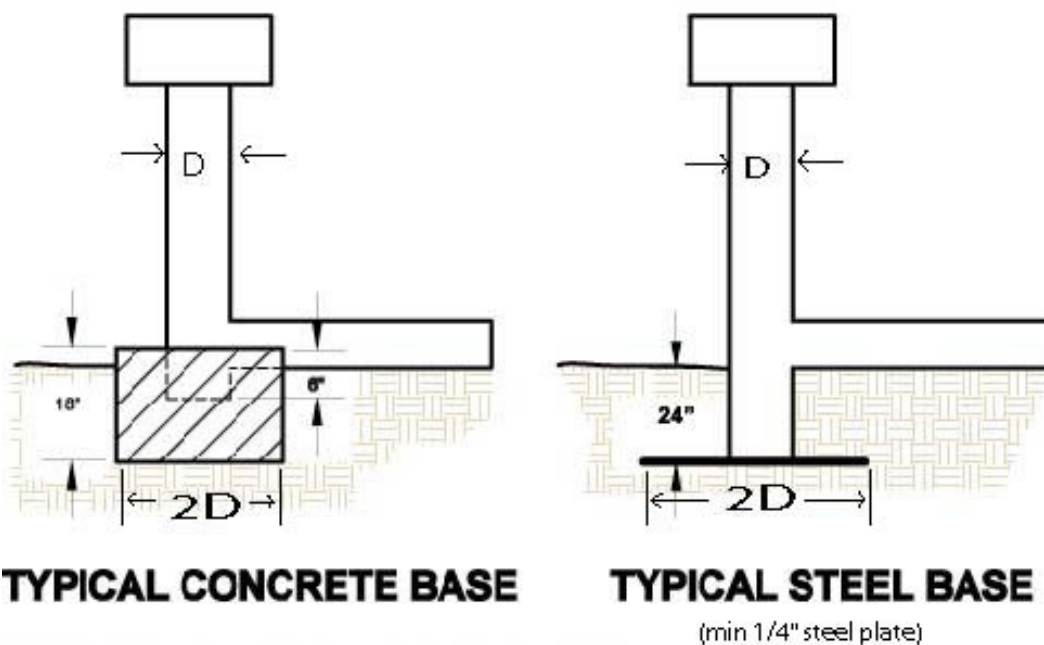

SOURCE: VA Erosion and Sediment Control Handbook, 1992

- ◆ The embankment material has a low silt or clay content and the barrel pipe diameter is 12 inches or greater.

The anti-seep collar and its connection to the barrel pipe shall be watertight. The maximum spacing shall be approximately 14 times the minimum projection of the collar measured perpendicular to the pipe. Minimum thickness of anti-seep collars shall be ¼-inch. Collars should not be located within 2 feet of a pipe joint. (refer to Figure 7-16)

**Figure 7-16: Anti-Seep Collars**

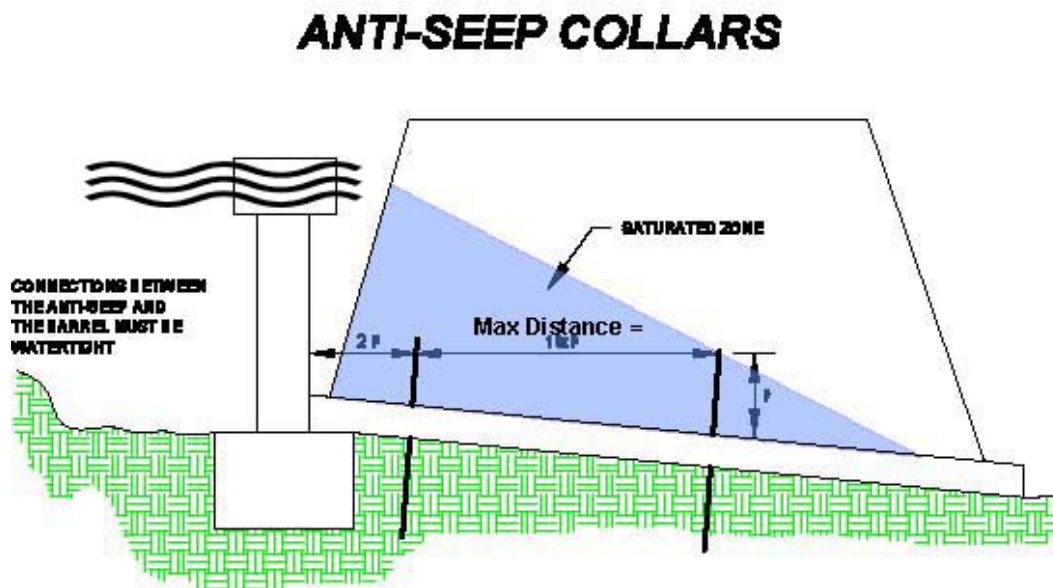

SOURCE: VA Erosion and Sediment Control Handbook, 1992

### **Outlet Protection**

Outlet protection is necessary at the discharge end of barrel pipes and open channel spillways to reduce the potential for downstream erosion and protect the outlet structure. These structures should be adequate to absorb the impact of the water being discharged and reduce the flow velocity to the point where it will not erode the receiving channel or area. The most commonly used structure is a riprap discharge apron installed on a level grade. These aprons should be designed and constructed per Figure 7-17 and Graphs 7-3 and 7-4. Outlet protection below open channel spillways should be extended a distance equal to their width from the base of the embankment.

### **Provision for Lowering Runoff Into Basin**

Channels directing surface runoff into basins shall be protected with riprap or other soil stabilization methods to prevent bank erosion. Diversions shall be installed as necessary to insure runoff is directed to protected entry points. Entry points to the basin should be located as far from the basin outlet as possible to insure maximum travel distance between

Figure 7-17: Pipe Outlet Conditions

## PIPE OUTLET CONDITIONS

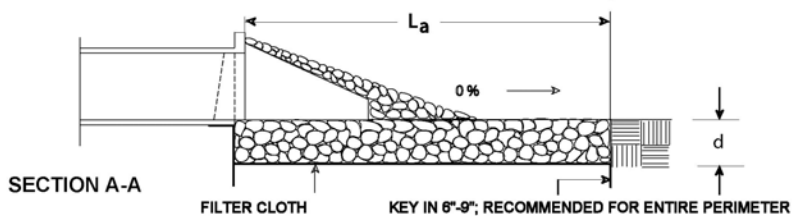
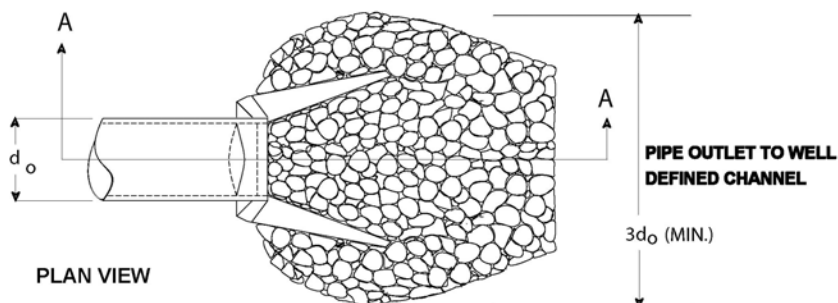
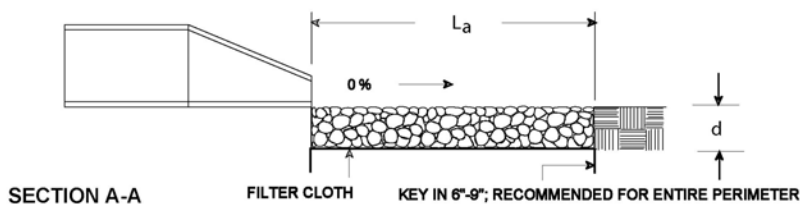
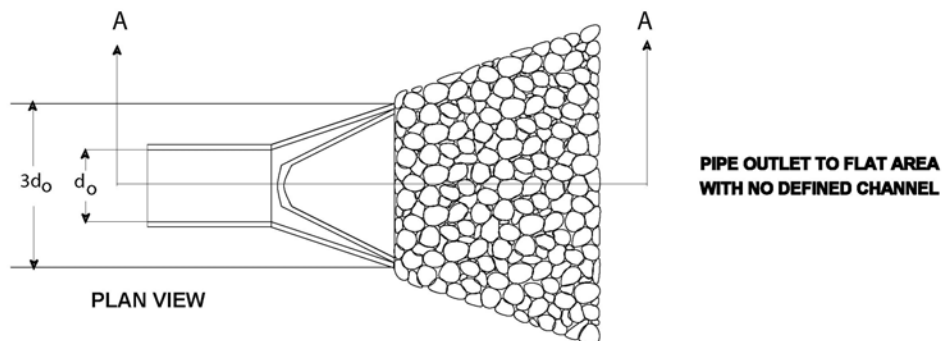

- NOTES:
1. APRON LINING MAY BE RIPRAP, GROUTED RIPRAP, GABION BASKET, OR CONCRETE
  2.  $L_a$  IS THE CALCULATED LENGTH OF THE RIPRAP APRON
  3.  $d = 1.5$  TIMES THE MAXIMUM STONE DIAMETER, BUT NOT LESS THAN 6 INCHES

SOURCE: VA Erosion and Sediment Control Handbook, 1992



**Graph 7-3: Design of Outlet Protection from a Round Pipe (Minimum Tailwater)**

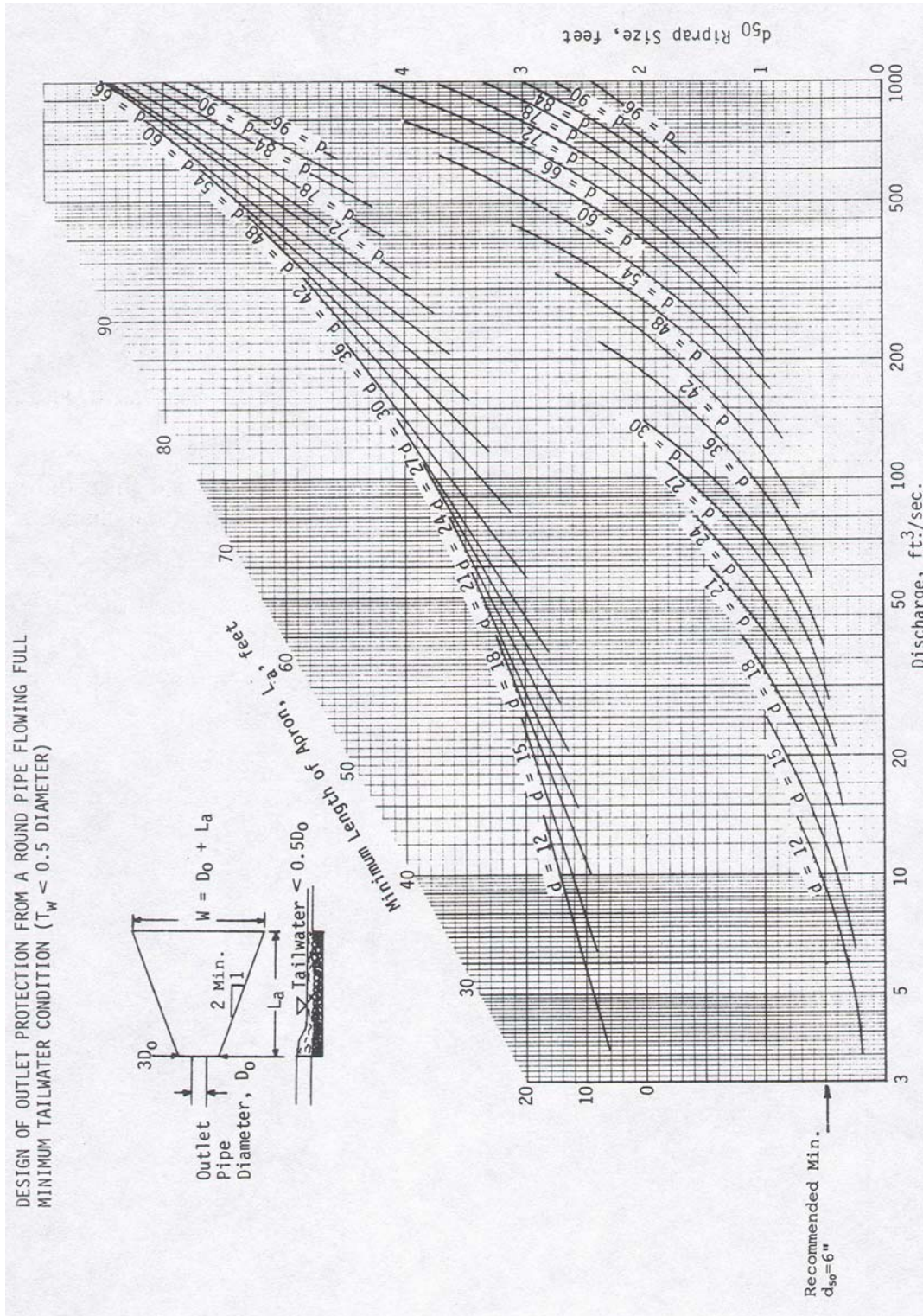

Source: VA Erosion and Sediment Control Handbook, 1992



**Graph 7-4: Design of Outlet Protection from a Round Pipe Flowing Full (Maximum Tailwater)**

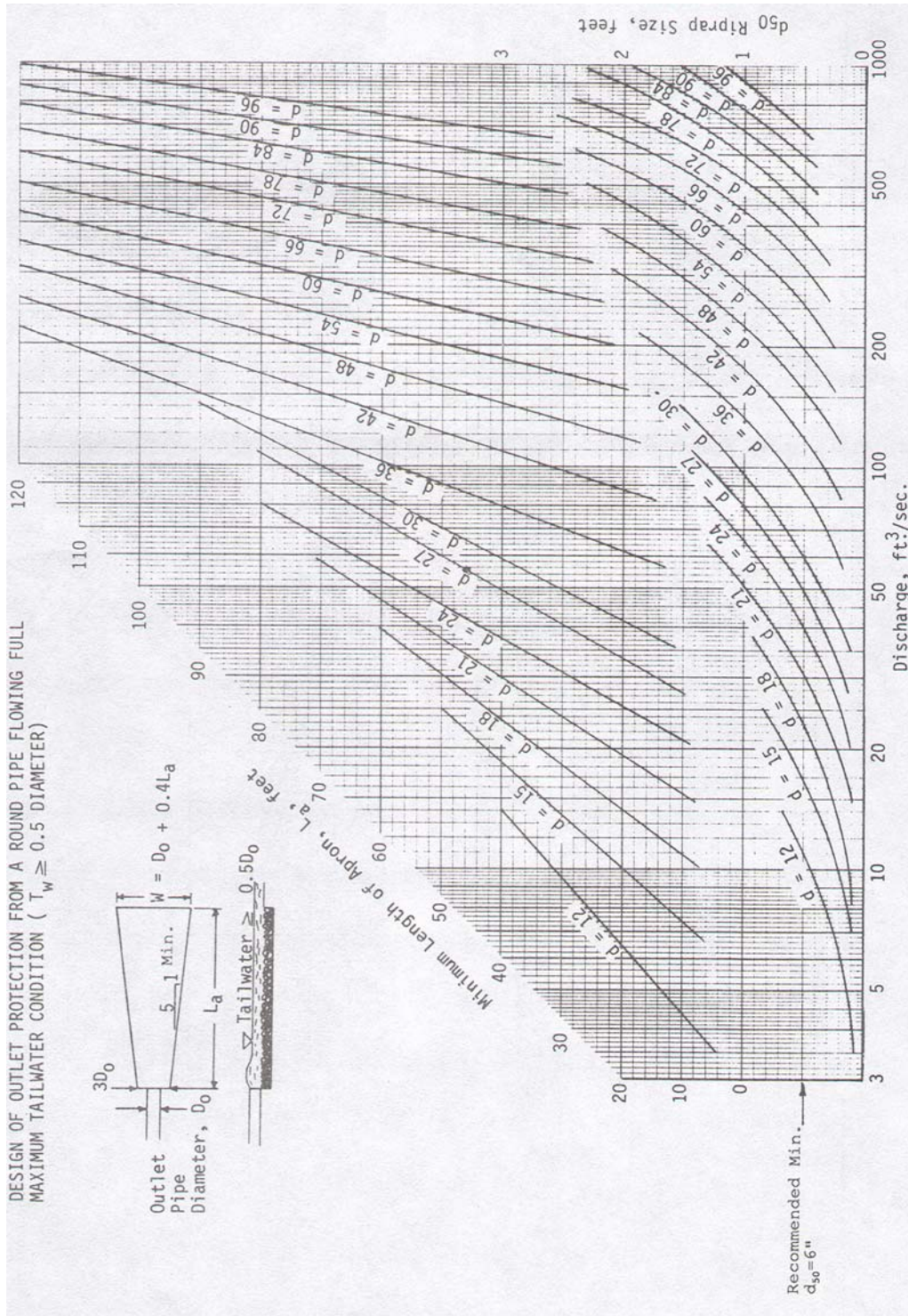

Source: VA Erosion and Sediment Control Handbook, 1992

basin entrance and exit points. This will maximize the retention time within the basin and aid in its ability to clarify the water flowing through the structure.

## **Construction Specifications**

### ***Site Preparation***

Areas under the basin embankment and any structural works shall be cleared, grubbed, and stripped of topsoil to remove trees, vegetation, roots, large rocks, or other objectionable material. In order to facilitate clean-out and restoration, the pool area (as measured up to the top of the spillway) shall be cleared of all brush and trees. Material removed during site preparation shall be disposed of in a location where it will not wash back into the basin.

### ***Cut-Off Trench***

A cut-off trench shall be excavated along the dam centerline for all earthen embankments. The minimum depth shall be 2 feet. The cut-off trench shall extend up both abutments to the crest elevation. The minimum bottom width shall be 4 feet, but in any event wide enough to permit operation of compaction equipment. The side slopes shall be no steeper than 1:1. Compaction requirements shall be the same as those for the embankment. The trench shall be kept drained during the backfilling and compacting operations.

### ***Embankment***

Embankment construction material shall be taken from borrow areas that contain enough clayey material to allow sufficient compaction, impermeability, and stability to be attained. Only clean mineral soil, free of roots, woody vegetation, stones over 6 inches, sod, or other objectionable material, shall be used. The most preferred embankment construction soils are sandy clay, gravely clay or low liquid limit clays. The most impervious material available shall be used in the cut-off trench and center portion of the dam. If sandy or gravely soil is encountered, it shall be placed in the outer shell, preferably in the down-stream portion of the dam. Fill material will be placed in 1-foot continuous layers over the entire length of the fill. Each layer of fill shall be adequately compacted and scarified prior to placement of the next layer. Fill material shall be placed at or near optimum moisture content and shall be adequately compacted by routing rubber-tired construction equipment over the entire surface. All fill material shall be traversed by at least one wheel of the equipment. Fill material may also be compacted by sheep-foot compactors or vibratory compactors as long as it is scarified prior to placement of the next layer. As a rule of thumb, where test facilities may not be available, the fill material should contain sufficient moisture so that it can be formed by hand into a ball without crumbling. If water can be squeezed out of the ball, it is too wet for proper compaction. The embankment shall be constructed on an elevation 10 percent higher than the design height to allow for settlement if compaction is obtained with hauling equipment. If compactors are used for compaction, the overbuild may be reduced to not less than 5 percent. Fill material shall be compacted to 95 percent of optimum density.

### **Pipe Spillways**

The riser shall be securely attached to the barrel, and all connections shall be watertight. The riser and barrel shall be placed on a firm smooth foundation. The riser shall be firmly anchored to prevent floating. Only good quality, clean mineral soil shall be used as fill material around the pipe. The fill material around the pipe shall be placed in 4-inch layers and compacted under the shoulders and around the pipe to at least the same density as the adjacent embankment. Particular attention should be given to the compaction of fill material adjacent to anti-seep collars. A minimum of 2 feet of hand compacted backfill should be placed over the pipe before crossing it with construction equipment.

### **Open Channel Spillways**

The open channel spillway must **not** be installed in fill unless approved to do so by DMM. Elevations, design width, entrance, and exit channel slopes are critical to the successful operation of the emergency spillway and shall be adhered to closely during construction.

### **Vegetative Treatment**

The completed embankment and open channel spillway shall be stabilized immediately with vegetation or riprap.

### **Erosion and Pollution Control**

Construction operations shall be carried out in such a manner that erosion and water pollution are minimized. Temporary sediment control structures shall be installed below the construction site prior to ground disturbing activities. All State and local laws concerning pollution abatement shall be complied with.

### **Safety**

State and local requirements shall be met concerning safety fencing and signs to warn the public of hazards associated with the structure.

### **Maintenance**

All damage caused by soil erosion or construction equipment shall be repaired before the end of each construction day. The completed embankment shall be inspected on a regular basis to ensure that it is structurally sound and free from damage. All damage shall be repaired immediately. Sediment shall be removed from the basin and disposed of in a suitable area when it reaches the 60 percent clean-out level.

Trash rack and anti-vortex devices shall be regularly inspected and kept clear of debris. The emergency spillway shall be regularly inspected, erosion damage repaired, and debris removed.

### **Abandonment Procedure for Temporary Basins**

After all disturbed areas above the basin are stabilized, the basin shall be backfilled or removed. Standing water shall be pumped or siphoned out of the basin, and sediment shall be removed, prior to placing backfill or removing the dam.

The area occupied by the basin shall be returned to its original profile and cross-section. Any remaining channel shall be riprapped or stabilized with a vegetative cover. Riprap used to line the base of the channel shall extend at least 1-foot above the point that water is expected to flow through the channel. Riprap requirements may be waived when the bottom and sides of the channel consist of stable bedrock.

Embankments and accumulated sediment removed during abandonment shall be spread on relatively flat areas and stabilized with appropriate vegetative cover. Diversions, berms and/or other control measures shall be installed to prevent erosion of this material. Fill slopes for this material shall be no steeper than 4 horizontal to 1 vertical.

All areas disturbed during abandonment of a sediment basin shall be vegetated as soon as possible after the project is completed.

## **7.7 SEDIMENT BASIN DESIGN EXAMPLES**

### **Excavated Sediment Basin Design Examples**

Given: Need a temporary basin

Desire a decant pipe or open channel spillway

Working with sandy clay soils

Topography consists of rolling hills

Disturbed area above basin = 5 acres

50-year storm runoff  $Q_{50} = 15$  cfs

In this example, we will design both an open channel spillway and pipe spillway that are capable of handling the total runoff.

#### ***Open channel spillway design***

The open channel spillway is designed using the Broad-Crested Weir Formula.

$$Q = CLH_1^{1.5} \text{ is equivalent to } H_1 = \sqrt[3]{\left(\frac{Q}{CL}\right)^2}$$

Where:

Q = Discharge requirement

C = Roughness Coefficient - use 2.63

L = Effective Length of spillway crest

$H_1$  = Required Head on spillway crest

We will use this formula to determine the depth of water ( $H_1$ ) flowing over the spillway based on a reasonable spillway length (L). (Figure 7-18)

Figure 7-18: Sediment Pond Using Open Channel Spillway

**SEDIMENT POND USING OPEN CHANNEL SPILLWAY**

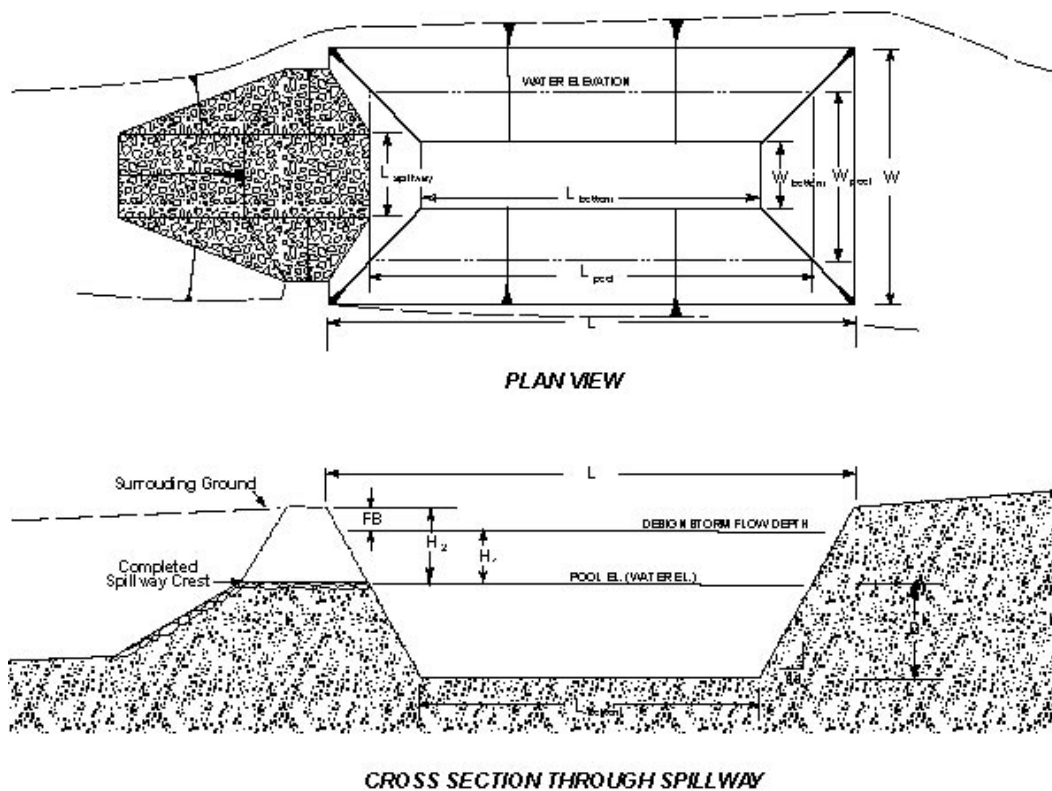

- FB = Required Freeboard (1' min.)
- H<sub>1</sub> = Head over spillway crest (design head)
- H<sub>2</sub> = Total head on spillway crest
- D = Pool Depth
- L = Length
- W = Width
- SS = Side Slope

If we try an  $L = 8$  feet, we find that the flow depth over the spillway will be 0.8 ft.

$$H_1 = \sqrt[3]{\left(\frac{15}{(2.63)(8)}\right)^2} = 0.8 \text{ feet}$$

To find the total head required (the depth of the completed spillway relative to the lowest point in the pond embankment or surrounding ground), use the following formula.

$$H_2 = H_1 + FB$$

Where:

- $H_2$  = Total head on spillway crest
- $H_1$  = Required head on spillway crest
- FB = Required freeboard (minimum of one foot)

In this example, the depth of the completed spillway will need to be 1.8 ft.

$$H_2 = 0.8 \text{ ft} + 1.0 \text{ ft} = 1.8 \text{ ft}$$

Note:

- ◆ At least 1-foot of freeboard must be maintained between the maximum pond elevation and lowest point in the pond embankment or surrounding ground.
- ◆ The length of the spillway crest ( $L$ ) may exceed 8 feet, if needed, to obtain a more acceptable spillway head ( $H_2$ ). The wider the length of the spillway, the smaller the head requirement.
- ◆ If the spillway conveys water only a short distance to the natural drainway, this design size is generally acceptable for the entire spillway. If the spillway must convey water a considerable distance to a natural drainway or protected channel, and significant grade changes are necessary, you should design the remainder of the channel (below the spillway) as a diversion ditch using Manning's equation.
- ◆ Proper erosion protection must be applied within the spillway and outlet channel.

### **Decant Pipe Design**

We will design the decant pipe using graphs and charts.

The first thing we will determine is the diameter and head requirements for the riser pipe. The riser may be designed by using Graph 7-5. This graph shows the size of the riser (riser diameter,  $D$ ) as a function of the discharge it needs to convey (watershed discharge,  $Q$ ) and the height of water that will be needed above the top of the riser to obtain that flow rate (head on the riser,  $H$ ).

In our design example;  $Q = 15$  cfs



**Graph 7-5: Riser Inflow Curves**

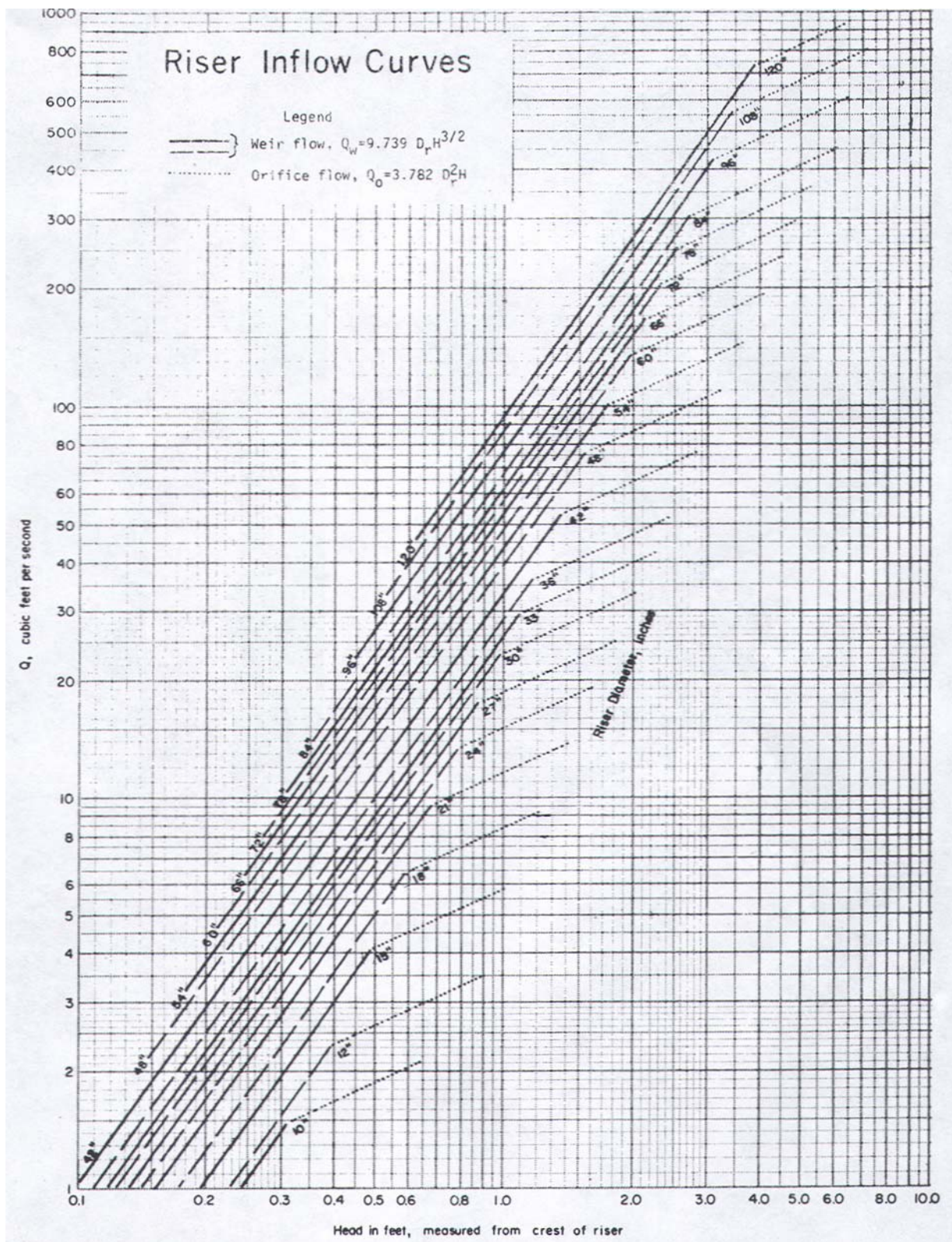

Source: VA Erosion and Sediment Control Handbook, 1992

Enter the left side of the graph (Graph 7-5) at 15 cfs; move horizontally to the 24-inch curve; turn a right angle downward and read the head requirement of 1 foot. So, from the graph, it is shown that a 24-inch diameter riser can decant 15 cfs when the water depth in the pond is one foot above the top of the riser.

The next step is to design the horizontal pipe, or barrel pipe, that will run under the embankment. This can be accomplished by using the Pipe Flow Charts in Tables 7-6 or 7-7. These charts can be used with either an assumed pipe size (D) or an assumed head (H). Since topography more often dictates the allowable head, it is recommended that the allowable head be estimated, then use that value in the chart to select the size of the barrel pipe.

Estimate the head on the barrel pipe (H) by examining the parameters that make up the head. These parameters are shown in Figures 7-19 and 7-20.

Using these parameters the head on the barrel pipe (H) can be determined by the equation

$$H = h + LR + S(LB) - 0.5D_p$$

h = head over riser crest = 1.0' (already determined from Graph 7-5)

LR = length of riser = 4.0' (assumed, will check against pond dimensions to be determined later in the example)

S = slope of barrel pipe = 5% or 0.05 ft/ft (from site measurements)

D<sub>p</sub> = diameter of barrel pipe = 2.0' (try same size as riser)

LB = length of barrel pipe = 40 ft (from site measurements)

$$H = h + LR + S(LB) - 0.5D_p$$

$$H = 1.0' + 4.0' + 0.05(40') - 0.5(2.0') = 6.0 \text{ ft}$$

Go to Table 7-6 for corrugated metal pipe to find the pipe barrel capacity based on the assumed parameters.

Enter the table (Table 7-6) with a head (H) of 6 feet; then go across to the 24-inch pipe column. According to the table, the pipe capacity is 27.0 cfs and all that is needed is 15 cfs. Here notice that the chart is direct reading only for 70-foot pipe lengths and a correction factor must be used for other lengths. Go to the bottom of the table and enter the correction chart with the barrel pipe length (LB), which is 40 feet in our example. Go across to the 24-inch pipe column and read the correction factor of 1.17. Correct the original capacity value of 27.0 cfs by multiplying by the correction factor of 1.17.

$$27.0 \times 1.17 = 31.59 \text{ cfs}$$

Therefore, we know the 24-inch barrel pipe will provide more than enough capacity, almost twice the capacity of the 24-inch riser pipe. In this example, we can actually decrease the size of the barrel to 18-inches. If we plug an 18-inch pipe into our formula and go back to Table 7-6 we will find that an 18-inch barrel pipe will provide the necessary flow capacity.



**Table 7- 6: Pipe Flow Chart, n = 0.025**

Pipe Flow Chart, n = 0.025																					
Pipe Flow (cfm) for Corrugated Metal Pipe Inlet $K_m = K_e + K_b = 1.0$ and 70 Feet of Corrugated Metal Pipe Conduit (full flow assumed)																					
Note correction factors for pipe lengths other than 70 feet diameter of pipe in inches																					
Diameter of Pipe in Inches																					
H, in feet	6"	8"	10"	12"	15"	18"	21"	24"	30"	36"	42"	48"	54"	60"	66"	72"	78"	84"	90"	96"	102"
1	0.33	0.70	1.25	1.98	3.48	5.47	7.99	11.0	18.8	28.8	41.1	55.7	72.6	91.8	113	137	163	191	222	255	290
2	0.47	0.99	1.76	2.80	4.92	7.74	11.3	15.6	26.6	40.8	58.2	78.8	103	130	160	194	231	271	314	360	410
3	0.58	1.22	2.16	3.43	6.02	9.48	13.8	19.1	32.6	49.9	71.2	96.5	126	159	196	237	282	331	384	441	502
4	0.67	1.40	2.49	3.97	6.96	10.9	16.0	22.1	37.6	57.7	82.3	111	145	184	226	274	326	383	444	510	580
5	0.74	1.57	2.79	4.43	7.78	12.2	17.9	24.7	42.1	64.5	92.0	125	162	205	253	306	365	428	496	570	648
6	0.82	1.72	3.05	4.86	8.52	13.4	19.6	27.0	46.1	70.6	101	136	178	225	277	336	399	469	544	624	710
7	0.88	1.86	3.30	5.25	9.20	14.5	21.1	29.2	49.8	76.3	109	147	192	243	300	362	431	506	587	674	767
8	0.94	1.99	3.53	5.61	9.84	15.5	22.6	31.2	53.2	81.5	116	158	205	260	320	388	461	541	628	721	820
9	1.00	2.11	3.74	5.95	10.4	16.4	24.0	33.1	56.4	86.5	123	167	218	275	340	411	489	574	666	764	870
10	1.05	2.22	3.94	6.27	11.0	17.3	25.3	34.9	59.5	91.2	130	176	230	290	358	433	516	605	702	806	917
11	1.10	2.33	4.13	6.58	11.5	18.2	26.5	36.6	62.4	95.6	136	185	241	304	376	454	541	635	736	845	962
12	1.15	2.43	4.32	6.87	12.1	19.0	27.7	38.2	65.2	99.9	142	193	252	318	392	475	565	663	769	883	1004
13	1.20	2.53	4.49	7.15	12.6	19.7	28.8	39.8	67.8	104	148	201	262	331	408	494	588	690	800	919	1045
14	1.25	2.63	4.66	7.42	13.0	20.5	29.9	41.3	70.4	108	154	208	272	343	424	513	610	716	830	953	1085
15	1.29	2.72	4.83	7.68	13.5	21.2	30.9	42.8	72.8	112	159	216	281	355	439	531	631	741	860	987	1123
16	1.33	2.81	4.99	7.93	13.9	21.9	32.0	44.2	75.2	115	165	223	290	367	453	548	652	765	888	1019	1160
17	1.37	2.90	5.14	8.18	14.3	22.6	32.9	45.5	77.5	119	170	230	229	378	467	565	672	789	915	1051	1195
18	1.41	2.98	5.29	8.41	14.8	23.2	33.9	46.8	79.8	120	174	236	308	389	480	581	692	812	942	1081	1230
19	1.45	3.06	5.43	8.64	15.2	23.9	34.8	48.1	82.0	126	179	243	316	400	494	597	711	834	967	1111	1264
20	1.49	3.14	5.57	8.87	15.6	24.5	35.7	49.4	84.1	129	184	249	325	410	506	613	729	856	993	1139	1297

Pipe Flow Chart, n = 0.025																					
Pipe Flow (cfm) for Corrugated Metal Pipe Inlet $K_m = K_e + K_b = 1.0$ and 70 Feet of Corrugated Metal Pipe Conduit (full flow assumed)																					
Note correction factors for pipe lengths other than 70 feet diameter of pipe in inches																					
Diameter of Pipe in Inches																					
H, in feet	6"	8"	10"	12"	15"	18"	21"	24"	30"	36"	42"	48"	54"	60"	66"	72"	78"	84"	90"	96"	102"
21	1.53	3.22	5.71	9.09	15.9	25.1	36.6	50.6	86.2	132	188	255	333	421	519	628	747	877	1017	1168	1329
22	1.56	3.29	5.85	9.30	16.3	25.7	37.5	51.8	88.2	135	193	261	341	430	531	643	765	989	1041	1195	1360
23	1.60	3.37	5.98	9.51	16.7	26.2	38.3	53.0	90.2	138	197	267	348	440	543	657	782	918	1064	1222	1390
24	1.63	3.44	6.11	9.72	17.0	26.8	39.1	54.1	92.1	141	201	273	356	450	555	671	799	937	1087	1248	1420
25	1.66	3.51	6.23	9.92	17.4	27.4	39.9	55.2	94.0	144	206	279	363	459	566	685	815	957	1110	1274	1450
26	1.70	3.58	6.36	10.1	17.7	27.9	40.7	56.3	95.9	147	210	284	370	468	577	699	831	976	1132	1299	1478
27	1.73	3.65	6.48	10.3	18.1	28.4	41.5	57.4	97.7	150	214	290	377	477	588	712	847	994	1153	1324	1507
28	1.76	3.72	6.60	10.5	18.4	29.0	42.3	58.4	99.5	153	218	295	384	486	599	725	863	1013	1174	1348	1534
29	1.79	3.78	6.71	10.7	18.7	29.5	43.0	59.5	101	155	221	300	391	494	610	738	878	1030	1195	1372	1561
30	1.82	3.85	6.83	10.9	19.1	30.0	43.7	60.5	103	158	225	305	398	503	620	750	893	1048	1216	1396	1588
L, in feet	Correction Factors for Other Pipe Lengths																				
20	1.69	1.63	1.58	1.53	1.47	1.42	1.37	1.34	1.28	1.24	1.20	1.18	1.16	1.14	1.13	1.11	1.10	1.10	1.09	1.08	1.08
30	1.44	1.41	1.39	1.36	1.32	1.29	1.27	1.24	1.21	1.18	1.15	1.13	1.12	1.11	1.10	1.09	1.08	1.07	1.07	1.06	1.06
40	1.28	1.27	1.25	1.23	1.21	1.20	1.18	1.17	1.14	1.12	1.11	1.10	1.09	1.08	1.07	1.06	1.06	1.05	1.05	1.05	1.04
50	1.16	1.16	1.15	1.14	1.13	1.12	1.11	1.10	1.09	1.08	1.07	1.06	1.06	1.05	1.05	1.04	1.04	1.04	1.03	1.03	1.03
60	1.07	1.07	1.07	1.06	1.06	1.05	1.05	1.05	1.04	1.04	1.03	1.03	1.03	1.02	1.02	1.02	1.02	1.02	1.02	1.02	1.01
70	1.00	1.00	1.00	1.00	1.00	1.00	1.00	1.00	1.00	1.00	1.00	1.00	1.00	1.00	1.00	1.00	1.00	1.00	1.00	1.00	1.00
80	.94	.94	.95	.95	.95	.95	.96	.96	.96	.97	.97	.97	.98	.98	.98	.98	.98	.98	.99	.99	.99
90	.89	.89	.90	.90	.91	.91	.92	.92	.93	.94	.94	.95	.95	.96	.96	.96	.97	.97	.97	.97	.94
100	.85	.85	.86	.86	.87	.88	.89	.89	.90	.91	.92	.93	.93	.94	.94	.95	.95	.95	.96	.96	.94
120	.78	.79	.79	.90	.81	.82	.83	.83	.85	.86	.87	.89	.89	.90	.91	.89	.92	.93	.93	.94	.92
140	.72	.73	.74	.75	.76	.77	.78	.79	.81	.82	.84	.85	.86	.87	.88	.86	.89	.90	.91	.91	.90
160	.68	.69	.69	.70	.71	.73	.74	.75	.77	.79	.80	.82	.83	.84	.85	.92	.87	.88	.89	.89	

**Table 7-7: Pipe Flow Chart, n = 0.013**

**Pipe Flow Chart, n = 0.013**

Pipe Flow (cfs) for Reinforced Concrete Pipe Inlet $K_m = K_e + K_b = 0.65$ and 70 Feet of Reinforced Concrete Pipe Conduit (full flow assumed) Note correction factors for pipe lengths other than 70 feet.																		
Diameter of pipe in inches																		
H, in feet	12"	15"	18"	21"	24"	30"	36"	42"	48"	54"	60"	66"	72"	78"	84"	90"	96"	102"
1	3.22	5.44	8.29	11.8	15.9	26.0	38.6	53.8	71.4	91.5	114	139	167	197	229	264	302	342
2	4.55	7.69	11.7	16.7	22.5	36.8	54.6	76.0	101	129	161	197	236	278	324	374	427	483
3	5.57	9.42	14.4	20.4	27.5	45.0	66.9	93.1	124	159	198	241	289	341	397	458	523	592
4	6.43	10.9	16.6	23.5	31.8	52.0	77.3	108	143	183	228	278	334	394	459	529	604	683
5	7.19	12.2	18.5	26.3	35.5	58.1	86.4	120	160	205	255	311	373	440	513	591	675	764
6	7.88	13.3	20.3	28.8	38.9	63.7	94.6	132	175	224	280	341	409	482	562	647	739	837
7	8.51	14.4	21.9	31.1	42.0	68.8	102	142	189	242	302	368	441	521	607	699	798	904
8	9.10	15.4	23.5	33.3	44.9	73.5	109	152	202	259	323	394	472	557	685	748	854	966
9	9.65	16.3	24.9	35.3	47.7	78.0	116	161	214	275	342	418	500	590	688	793	905	1025
10	10.2	17.2	26.2	37.2	50.2	82.2	122	170	226	289	361	440	527	622	725	836	954	1080
11	10.7	18.0	27.5	39.0	52.7	86.2	128	178	237	304	379	462	553	653	761	877	1001	1133
12	11.1	18.9	28.7	40.8	55.0	90.1	134	186	247	317	395	482	578	682	794	916	1045	1184
13	11.6	19.6	29.9	42.4	57.3	93.7	139	194	257	330	411	502	601	710	827	953	1088	1232
14	12.0	20.4	31.0	44.1	59.4	97.3	145	201	267	342	427	521	624	736	858	989	1129	1278
15	12.5	21.1	32.1	45.6	61.5	101	150	208	277	354	442	539	646	762	888	1024	1169	1323
16	12.9	21.8	33.2	47.1	63.5	104	155	215	286	366	457	557	667	787	917	1057	1207	1367
17	13.3	22.4	34.2	48.5	65.5	107	159	222	294	377	471	574	688	812	946	1090	1244	1409
18	13.7	23.1	35.2	49.9	67.4	110	164	228	303	388	484	591	708	835	973	1121	1280	1450
19	14.0	23.7	36.1	51.3	69.2	113	168	234	311	399	497	607	727	858	1000	1152	1315	1489
20	14.4	24.3	37.1	52.6	71.0	116	173	240	319	409	510	623	746	880	1026	1182	1350	1528
21	14.7	24.9	38.0	53.9	72.8	119	177	246	327	419	523	638	764	902	1051	1211	1383	1566

**Pipe Flow Chart, n = 0.013**

Pipe Flow (cfs) for Reinforced Concrete Pipe Inlet $K_m = K_e + K_b = 0.65$ and 70 Feet of Reinforced Concrete Pipe Conduit (full flow assumed) Note correction factors for pipe lengths other than 70 feet.																		
Diameter of pipe in inches																		
H, in feet	12"	15"	18"	21"	24"	30"	36"	42"	48"	54"	60"	66"	72"	78"	84"	90"	96"	102"
22	15.1	25.5	38.9	55.2	74.5	122	181	252	335	429	535	653	782	923	1076	1240	1415	1603
23	15.4	26.1	39.8	56.5	76.2	125	186	258	342	439	547	668	800	944	1100	1268	1447	1639
24	15.8	26.7	40.6	57.7	77.8	127	189	263	350	448	559	682	817	964	1123	1295	1478	1674
25	16.1	27.2	41.5	58.9	79.4	130	193	269	357	458	571	696	834	984	1147	1322	1509	1708
26	16.4	27.7	42.3	60.0	81.0	133	197	274	364	467	582	710	850	1004	1169	1348	1539	1742
27	16.7	28.3	43.1	61.2	82.5	135	201	279	371	476	593	723	867	1023	1192	1373	1568	1775
28	17.0	28.8	43.9	62.3	84.1	138	204	285	378	484	604	737	883	1041	1214	1399	1597	1808
29	17.3	29.3	44.7	63.4	85.5	140	208	290	384	493	615	750	898	1060	1235	1423	1625	1840
30	17.6	29.8	45.4	64.5	87.0	142	212	294	391	501	625	763	913	1078	1256	1448	1653	1871
L, in feet	Correction Factors for Other Pipe Lengths																	
20	1.30	1.24	1.21	1.18	1.15	1.12	1.10	1.08	1.07	1.06	1.05	1.05	1.04	1.04	1.03	1.03	1.03	1.03
30	1.22	1.18	1.15	1.13	1.12	1.09	1.08	1.06	1.05	1.05	1.04	1.04	1.03	1.03	1.03	1.02	1.02	1.02
40	1.15	1.13	1.11	1.10	1.08	1.07	1.05	1.05	1.04	1.03	1.03	1.03	1.02	1.02	1.02	1.02	1.02	1.02
50	1.09	1.08	1.07	1.06	1.05	1.04	1.04	1.03	1.03	1.02	1.02	1.02	1.02	1.01	1.01	1.01	1.01	1.01
60	1.04	1.04	1.03	1.03	1.03	1.02	1.02	1.02	1.01	1.01	1.01	1.01	1.01	1.01	1.01	1.01	1.01	1.01
70	1.00	1.00	1.00	1.00	1.00	1.00	1.00	1.00	1.00	1.00	1.00	1.00	1.00	1.00	1.00	1.00	1.00	1.00
80	.96	.97	.97	.97	.98	.98	.98	.99	.99	.99	.99	.99	.99	.99	.99	.99	.99	.99
90	.93	.94	.94	.95	.95	.96	.97	.97	.98	.98	.98	.98	.98	.99	.99	.99	.99	.99
100	.90	.91	.92	.93	.93	.95	.95	.96	.97	.97	.97	.98	.98	.98	.98	.98	.98	.99
120	.84	.86	.87	.89	.90	.91	.93	.94	.94	.95	.96	.96	.96	.97	.97	.97	.97	.98
140	.80	.82	.83	.85	.86	.88	.90	.91	.92	.93	.94	.94	.95	.95	.96	.96	.96	.97
160	.76	.78	.80	.82	.83	.86	.88	.89	.90	.91	.92	.93	.94	.94	.95	.95	.95	.96

Figure 7-19: Sediment Pond Using Pipe Spillway

## SEDIMENT POND USING PIPE SPILLWAY

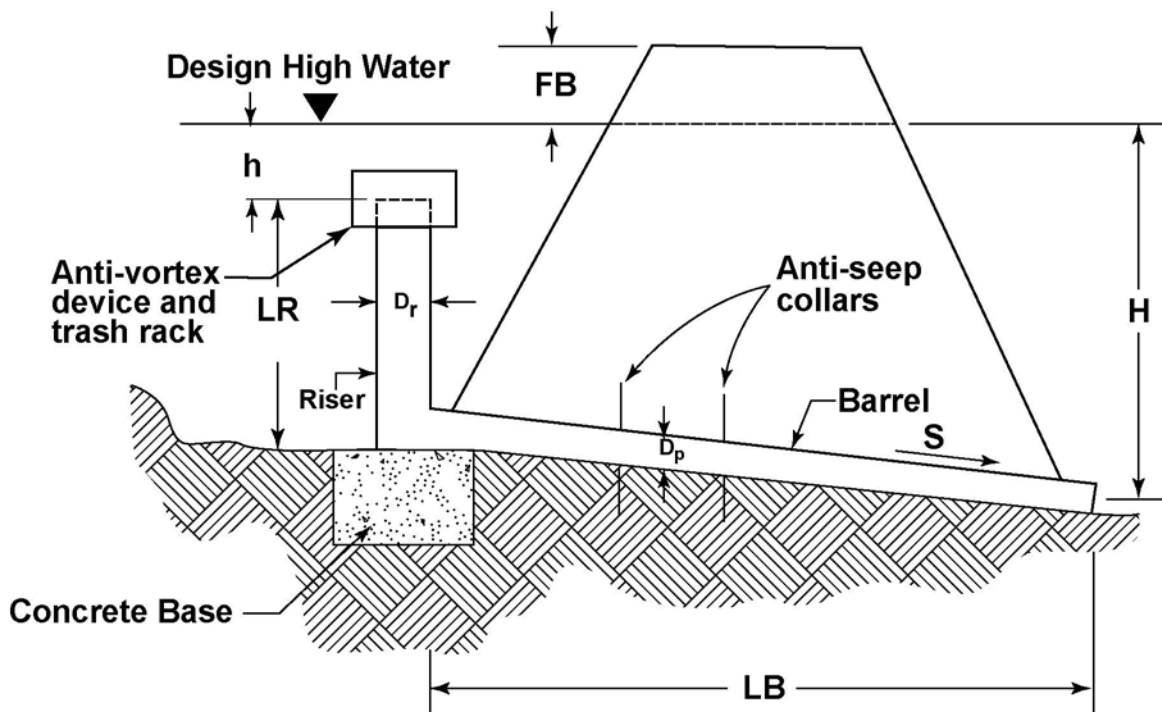

- FB = Design Freeboard (2' min. without open channel spillway)
- H = Head on barrel pipe through embankment
- h = Head over riser crest (design head)
- LB = Length of barrel pipe through embankment
- LR = Length of Riser
- $D_p$  = Diameter of barrel pipe through embankment
- $D_r$  = Diameter of riser pipe
- S = Slope of barrel pipe in percent or ft./ft.

Source: VA Erosion and Sediment Control Handbook, 1992

Figure 7-20: Sediment Pond Using Decant Pipe

## SEDIMENT POND USING DECANT PIPE

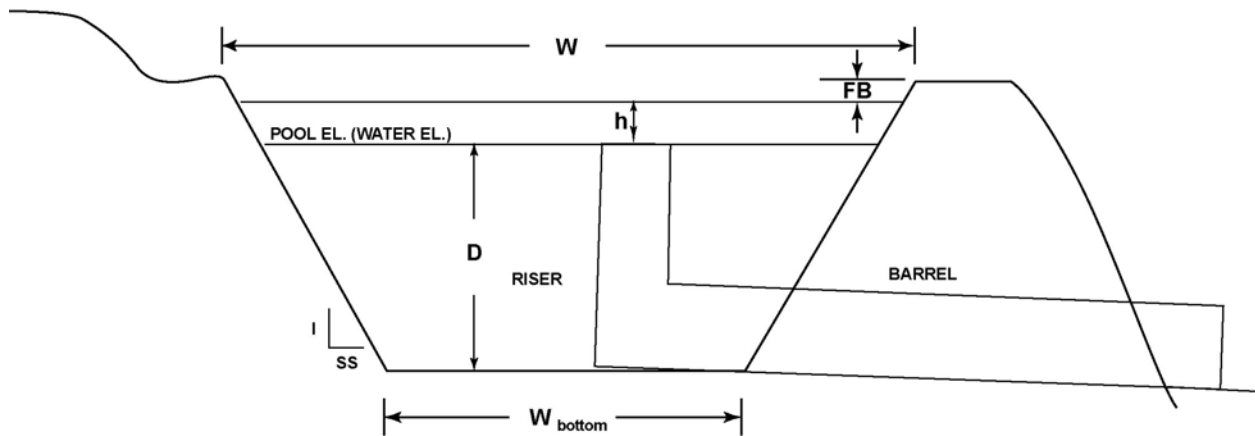
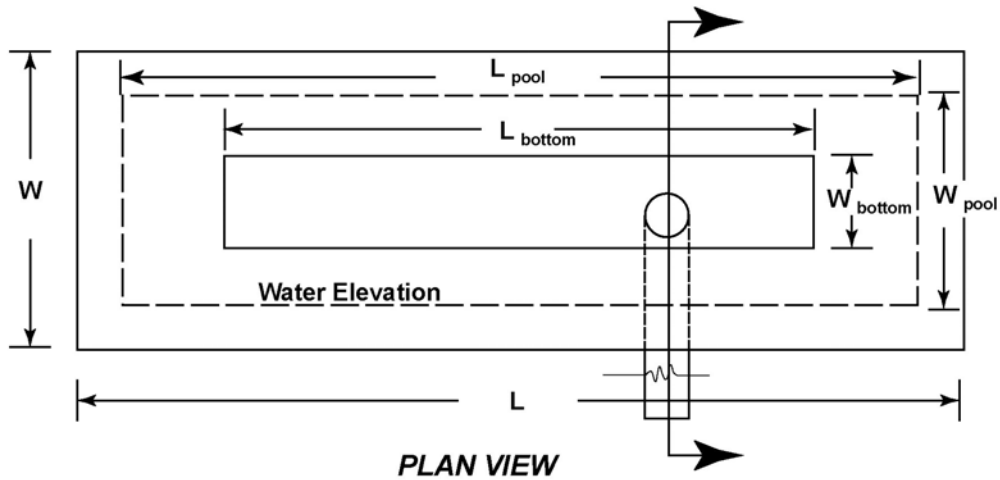

- FB = Required Freeboard (2' min.)**
- h = Head over spillway crest (design head)**
- D = Pool depth**
- L = Length**
- W = Width**
- SS = Side slope**

Using a barrel pipe diameter ( $D_p$ ) of 1.5 ft.

$$H = h + LR + S(LB) = 0.5D_p$$

$$H = 1.0 \text{ ft} + 4.0 \text{ ft} + 0.05(40 \text{ ft}) - 0.5(1.5 \text{ ft}) = 6.25 \text{ ft}$$

H = 6 ft. (we can use 6 feet and stay on the conservative side of our design)

Enter Table 7-6 with a head (H) of 6 feet; then go across to the 18-inch pipe column. We see that the pipe capacity is 13.4 cfs. Go to the bottom of the table and enter the correction chart with the barrel pipe length (LB), which is 40 feet in our example. Go across to the 18-inch pipe column and read the correction factor of 1.20. Correct the original capacity value of 13.4 cfs by multiplying by the correction factor of 1.20.

$$13.4 \times 1.20 = 16.08 \text{ cfs}$$

From this example we have determined that a 24-inch riser with 18-inch barrel pipe will decant the 50-year storm inflow of  $Q = 15 \text{ cfs}$ .

Use 24-inch corrugated metal pipe in riser = 15 CFS

Use 18-inch corrugated metal pipe in barrel = 16 CFS (effectively only 15 cfs)

Note:

- The head above the riser should be measured from the top of the riser, not the trash rack or skimmer.
- If an open channel spillway is not provided, at least 2 feet of freeboard must be maintained between the maximum pond elevation and the lowest point in surrounding ground. Therefore, after we determine the required head above the riser, we will need to add 2 feet to that to determine the distance that needs to be maintained between the top of the riser and surrounding ground.
- Corrugated metal pipe risers almost always need to be anchored in place to prevent them from floating as the pond fills with water. The weight of steel risers does not come near the weight of water displaced by the riser. Since the riser is lighter than the water displaced, it will need to be weighted down to prevent it from breaking loose from the barrel pipe.
- Proper erosion protection must be applied at the barrel pipe outlet.

### **Pond Design**

To design the sediment pond you must determine the disturbed acreage to be treated by the pond, determine the size of the pond you can build in the available area, and determine the side slopes to be constructed in the pond. (Table 7-8)

**Table 7-8: Acceptable Side Slopes**

<b>Soil Type</b>	<b>Excavated Side Slope</b>
Sand	3:1
Clay and compactable soils	2:1
Stone	Near vertical

Disturbed area above the pond = 5 acres

Clayey soil = use 2:1 side slopes

Required Pond Volume = (5 ac.)(0.125 ac.ft./ac.) = 0.625 ac. ft.

The pond is designed by trial-and-error until a pond size of adequate capacity is obtained. The trial size should consider the size of the area available for sediment pond construction.

Try a pond with top dimensions of 110 feet long (L) by 70 feet wide (W).

First find the water level or pool dimensions of the pond. Remember, the required pond volume is the volume of the pond below the discharge point. Since this volume will be smaller than the total excavated volume of the pond, we will need to use the following formulas to determine the dimensions, and volume of the pond. The final dimensions of the pond will be based on available construction area, the head required above the decant and freeboard requirements. For the purpose of this example, we will use a design head above the decant of one foot.

$$L_{\text{pool}} = L - 2 \times [\text{SS} \times (\text{h} + \text{FB})]$$

$$W_{\text{pool}} = W - 2 \times [\text{SS} \times (\text{h} + \text{FB})]$$

L = length of total excavation

W = width of total excavation

$L_{\text{pool}}$  = length of pool

$W_{\text{pool}}$  = Width of pool

SS = side slopes of pond (for 2:1 use 2; 3:1 use 3; vertical use 0)

h = design head above riser or open channel spillway

FB = freeboard, (1 foot for open channel spillway, 2 feet for pipe spillway without open channel spillway)

$$L_{\text{pool}} = 110 - 2 [2 \times (1 + 1)] = 110 - 8 = 102 \text{ feet}$$

$$W_{\text{pool}} = 70 - 2 [2 \times (1 + 1)] = 70 - 8 = 62 \text{ feet}$$

Next you must choose a trial water depth (D) for the pond and calculate the bottom dimensions:

$$L_{\text{bot}} = L_{\text{pool}} - 2 (\text{SS} \times \text{D})$$

$$W_{\text{bot}} = W_{\text{pool}} - 2 (\text{SS} \times \text{D})$$

$L_{\text{bot}}$  = length of bottom of pond

$W_{\text{bot}}$  = width of bottom of pond

SS = side slopes of pond

D = pool depth. This is the depth of water in the pond measured from the base of the spillway, or the top of the decant pipe, to the bottom of pond. (try 6 feet for this example)

$$L_{\text{bot}} = 102 - 2 (2 \times 6) = 102 - 24 = 78\text{ft}$$

$$W_{\text{bot}} = 62 - 2 (2 \times 6) = 62 - 24 = 38\text{ft}$$



Next, using the trial values, determine the storage volume of the trial pond. This is done by finding the average area of the pond multiplied by the depth. Use the following equation:

$$SV = D \left( \frac{(L_{pool} \times W_{pool}) + (L_{bot} \times W_{bot})}{2} \right)$$

SV = pond storage volume  
Other parameters previously defined

$$SV = 6 \left( \frac{(102 \times 62) + (78 \times 38)}{2} \right) = 6 \left( \frac{6,324 + 2,964}{2} \right) = 6(4,644) = 27,864 \text{ cu ft}$$

Change 27,864 ft<sup>3</sup> to acre-feet by dividing by 43,560 ft<sup>3</sup> / ac.ft.

$$\frac{27,864}{43,560} = 0.64 \text{ ac. ft.}$$

The 0.64 acre-feet trial pond is greater than the required storage volume of 0.625 acre-feet. Therefore, the trial pond is adequate to treat the runoff from 5 disturbed acres.

We must remember that the pool depth (D) is only the depth of water measured to the base of the spillway, or the top of the decant pipe. When water is flowing through the spillway or decant pipe it will flow at a depth known as the design head. In order to ensure that the water level does not overtop the sides of the pond we need to make sure an adequate amount of freeboard is maintained above the design head.

If an open channel spillway is provided, at least 1-foot of freeboard must be maintained between the maximum pond elevation and the lowest point in surrounding ground. If an open channel spillway is not provided, at least 2 feet of freeboard must be maintained between the maximum pond elevation and the lowest point in surrounding ground. Therefore, after we determine the design head above the spillway or riser pipe, we will need to add our freeboard requirement to that to determine the distance that needs to be maintained between the pool depth and surrounding ground.

$$CD \text{ (constructed depth of pond w/open channel spillway)} = D+h + FB = 6 \text{ ft} + 1 \text{ ft} + 1 \text{ ft} = 8 \text{ ft}$$

$$CD \text{ (constructed depth of pond w/ pipe spillway)} = D + h + FB = 6 \text{ ft} + 1 \text{ ft} + 2 \text{ ft} = 9 \text{ ft}$$

Using these calculations, our final dimensions for the pond are:

L = length of total excavation = 110 ft

W = width of total excavation = 70 ft

L<sub>pool</sub> = length of pool = 102 ft

W<sub>pool</sub> = width of pool = 62 ft

L<sub>bot</sub> = length of bottom of pond = 78 ft

W<sub>bot</sub> = width of bottom of pond = 38 ft

SS = side slopes of pond = 2:1

D = pool depth = 6 ft

CD = constructed depth = 8 ft or 9 ft depending on spillway type

## 7.8 SEDIMENT CHANNEL

A channel or ditch used to provide sediment control. A sediment channel can be described as a long narrow sediment pond or a nearly level ditch with stone barriers and protected outlets.

### Purpose

Sediment channels are used to control runoff, trap sediment and clarify water prior to discharge from the mine site.

### Conditions Where Practice Applies

Sediment channels are often used to provide sediment control in areas where there is not enough room to construct sediment basins. They are best suited for disturbed areas that are more subject to sheet erosion than erosion from concentrated flow. They work well below long, narrow disturbed areas such as screening berms.

### Design Criteria

The sediment channel should form a basin with a sediment storage capacity of 0.125 acre-feet per disturbed acre. Storage capacity should be based on the available level volume between check dams within the channel. See the design example in this section.

Sediment channels should only be used in flat to gently rolling terrain in order to insure near level sections within the channel. Channel sections may be stepped to accommodate mildly sloping terrain or constructed along the contours of the ground.

The channel should be located far enough from the toe of slopes so that accidental sloughing will not fill or block the channel. An access road should be provided beside the channel to allow for inspection and maintenance.

The channel may have either a V-notch or trapezoidal cross section. The depth of the sediment channel shall not exceed 5 feet. Cut slopes shall not exceed 1 horizontal to 1 vertical (1:1) and fill slopes shall not exceed 2 horizontal to 1 vertical (2:1). (Figure 7-21)

Where possible, sediment channels should be excavated structures. If embankments need to be constructed to form the channel, Sediment Basin construction specifications should be followed. Care should be taken not to impound water against the toe of a fill.

Rock check dams should be placed in the channel to slow the flow of water and provide sediment storage capacity. (Figure 7-22) They should be placed at intervals that will cause water and silt to back up from the top of the downstream dam to the toe of the upstream dam. Therefore, the distance between two dams shall be based on the height of the downstream dam and the grade of the ditch between it and the upstream dam. Riprap check dams shall be installed across the channel at intervals of 200 feet or less to filter sediment and insure that failure of one segment would not release the entire contents of the channel. The check dams shall be constructed of Class I riprap faced with at least 1 foot of VDOT #57's on the upstream side. The top width of the completed check dam shall be at least 5 feet. A spillway shall be provided across the top of each check dam by ensuring that

**Figure 7-21: Sediment Channel (Typical Cross-Section)**

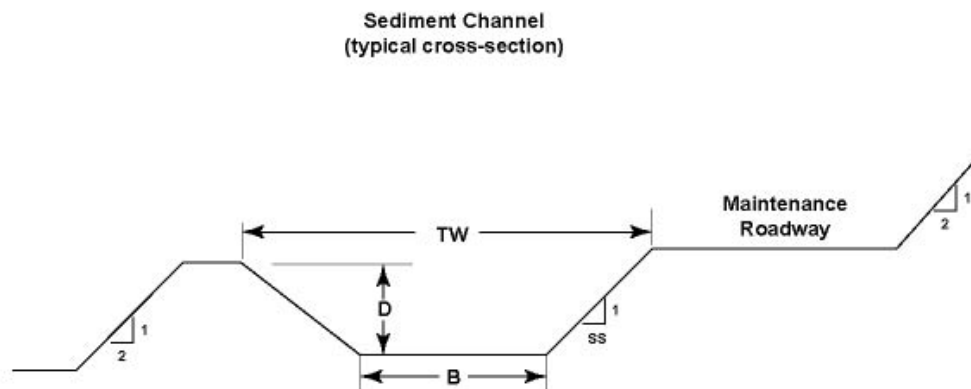

**Figure 7-22: Typical Rock Check Dam**

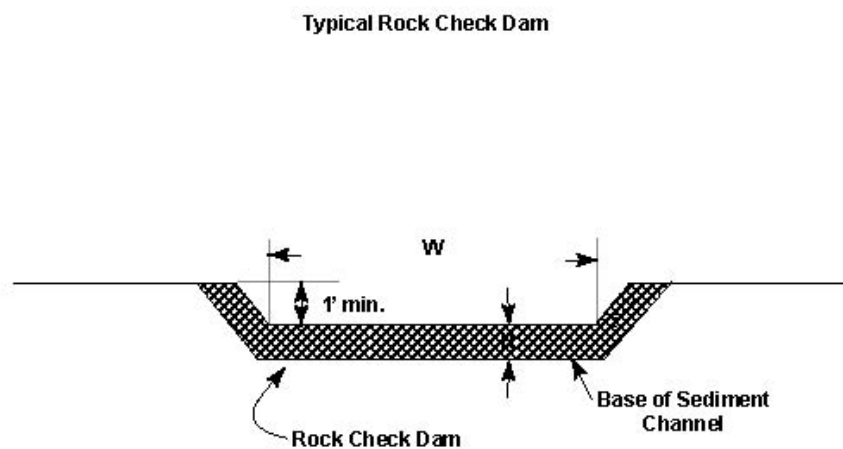

**$W = 6 \times$  Drainage Area (acres) above check dam unless shorter width is calculated using weir formula**

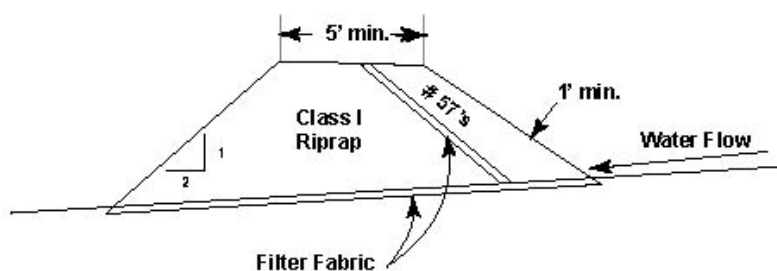

the top of the dam is set at least 1 foot below the top of the channel or channel embankment. The spillway shall be capable of conveying the runoff from a 25-year storm event while providing at least 6 inches of freeboard. At least one foot of riprap shall extend from the outside edges of the check dam to the top of the sediment channel to prevent scouring of channel sidewalls.

Outlets from the sediment channel may consist of open channel spillways or decant pipes or a combination of the two. (Figure 7-23) The capacity of the spillway should be capable of safely conveying the runoff from a 25-year storm event while providing at least 6 inches of freeboard. If designed using the guidelines below, spillways should be located at each point where an additional five acres of watershed has accumulated above the ditch. All outlets must be provided with suitable erosion protection.

### **Open Channel Spillways**

Unless designed by a qualified engineer, the width of open channel spillways should be 6 feet times the drainage area of the sediment channel. The spillway should be lined with at least 1 foot of Class I riprap with the top surface of the riprap set 1 foot below the lowest point along the top of the channel or channel embankment. At least one spillway should be provided for every 5 acres of watershed above the sediment channel. Spillways should be located where the cumulative drainage area equals 5 acres or less and should discharge into natural drainages.

### **Decant Pipe Spillways**

Unless designed by a qualified engineer, decant pipe spillways should be sized by Table 7-9. Decant pipe spillways shall consist of a riser and outlet pipe passing through the channel embankment. The diameter of the riser must be the same or larger than the diameter of the outlet pipe. The top of the riser should be set at least 1.5 feet below the lowest point along the top of the channel or channel embankment. The top two thirds of the riser may be perforated to provide draw down of the water level. Suitable perforations are ½-inch diameter holes spaced 8 inches vertically and 10 to 12 inches horizontally around the circumference of the riser. Crushed stone or filter fabrics should be used as a filter around the perforated riser. All pipe connections must be watertight. At least one spillway should be provided for every 5 acres of watershed above the sediment

**Table 7-9: Decant Pipe Spillway Size Chart**

<b>Maximum Drainage Area</b>	<b>Minimum Pipe Diameter</b>
1 acre	12 inches
2 acres	18 inches
3 acres	21 inches
4 acres	24 inches
5 acres	30 inches

**Figure 7-23: Typical Riprap Lined Channel Outlet**

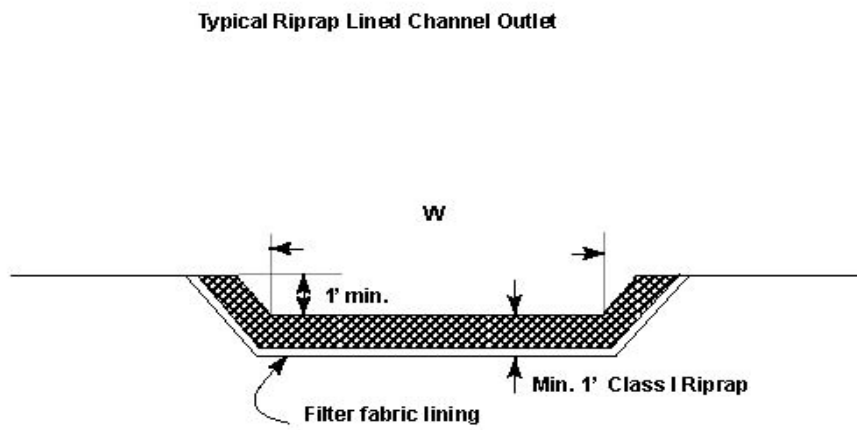

**W = 6x Drainage Area (acres) above check dam unless shorter width is calculated using weir formula**

## Construction Specifications

Install temporary sediment controls around the perimeter of the construction site.

Clear the area of trees, vegetation, topsoil and any other unsuitable materials.

Construct the channel to approved specifications.

If embankments are necessary to form the channel, their construction shall follow applicable construction specifications for sediment basins.

Seed and revegetate all areas disturbed in the construction process.

## Maintenance

The completed channel shall be inspected on a regular basis to ensure that it is structurally sound, free from damage and functioning as intended. All damage shall be repaired immediately. Sediment shall be removed from the channel and disposed of in a suitable area when it reaches 60 percent of the channel's storage capacity. Channel spillways shall be regularly inspected, erosion damage repaired, and debris removed.

## Abandonment

After disturbed areas have become stabilized with a vegetative cover and the sediment channel is no longer needed, the channel shall be reclaimed. The area occupied by the channel shall be returned to its original profile and cross-section or the channel may be stabilized with a riprap or vegetative cover. If the channel is going to be reclaimed in place, all accumulated sediment shall be removed from the channel and the check dams shall be knocked down and spread out to prevent concentrated flow. If riprap is necessary to stabilize the channel, it shall be used to line the base of the channel and shall extend at least 1-foot above the point that water is expected to flow through the channel. Riprap requirements may be waived when the bottom and/or sides of the channel consist of stable bedrock. All areas disturbed during abandonment of a sediment basin shall be vegetated in accordance with revegetation guidelines.

## Sediment Channel Design Example

Disturbed area = 6.0 acres

Length of proposed screening berm (disturbed area) = 1300 feet

Slope along proposed screening berm = 2 percent

Use 2:1 side slopes in channel excavation

In this example we will construct a channel with a trapezoidal cross-section. (refer to Figure 7-21)

Where: B = Bottom Width

D = Channel Depth = H + 1 ft

H = Height of Check Dams

SS = Side Slopes (for a 2:1 grade, SS = 2; for a 3:1 grade, SS =3)

TW = Top Width = B + 2(D)(SS)

A = Cross sectional area = (H x B) + H(SS x H )

$L = \text{Channel Length}$

$V = \text{Channel Storage Volume} = \frac{1}{2}(A \times L)$

The channel needs to be designed for a disturbed area = 6.0 acres.

The channel will be 1,300 feet long.

Required sediment storage within the channel = 6.0 acres x 0.125 ac.ft./ac = 0.75 acre-feet.

where, 0.75 acre-feet x 43,560 cubic feet/ac.ft. = 32,670 cubic feet

To design the channel we need to determine a set of dimensions that will provide the required sediment storage volume. Try a bottom width of 12 feet and a check dam height of 3 feet.

$V = \text{Channel Storage Volume} = \frac{1}{2}(A \times L)$

This is based on the check dams being spaced at intervals that will cause water and silt to back up from the top of the downstream dam to the toe of the upstream dam. Therefore the volume of water or silt impounded behind each dam will equal half of the volume of the channel between that dam and the next one upstream.

$A = \text{Cross sectional area} = (H \times B) + H(SS \times H)$

$A = (3 \text{ ft} \times 12 \text{ ft}) + 3\text{ft}(2 \times 3 \text{ ft})$

$A = 36 \text{ ft}^2 + 18 \text{ ft}^2$

$A = 54 \text{ square feet}$

$V = \text{Channel Storage Volume} = \frac{1}{2}(A \times L)$

$V = \frac{1}{2}(54 \text{ ft}^2 \times 1,300 \text{ ft}) = 35,100 \text{ ft}^3$

35,100 cubic feet will provide the sediment storage volume required for the 6.0 acre disturbed area.

Since at least 1 foot of freeboard should be provided between the top of each check dam and the top of the channel or channel embankment, the total depth of the completed channel should be 4 feet. Each of the rock check dams, constructed to provide sediment retention, should be constructed to a height of 3 feet.

$D = \text{Channel Depth} = H + 1 \text{ ft} = 3 \text{ ft} + 1 \text{ ft} = 4 \text{ ft.}$

The check dams should be placed at intervals that will cause water and silt to back up from the top of the downstream dam to the toe of the upstream dam. (refer to Figure 7-22) Therefore, the distance between two dams will be based on the height of the downstream dam and the grade of the ditch between it and the upstream dam. In our design example the height of the dams was 3 feet (ground level to spillway) and the grade along the ditch was 2 percent. Therefore, in our design example, the rock check dams should be placed at 150-foot intervals.

Spacing between dams =  $H / \text{percent grade} = 3 \text{ ft} / 0.02 = 150 \text{ ft}$



Spillways are also needed to control the discharge of water from the ditch. At least one spillway should be installed for every five acres of watershed above the ditch. (refer to Figure 7-23) Spillways should be located at each point where an additional five acres of watershed has accumulated above the ditch. Six acres were disturbed in the previous example. Dependent on how the watershed accumulated above the ditch, one properly designed spillway may be sufficient.

Based on the required design criteria, the spillway should be 36 feet wide and one foot deep.

SW = Spillway Width = 6 X Drainage Area  
SW = 6 X 6 = 36 ft.

## 7.9 STONE FILTER BERMS

### Definition

A sediment barrier constructed of crushed stone that is usually installed at the perimeter of the disturbed area.

### Purpose

1. To prevent sediment from leaving disturbed areas.
2. To decrease the velocity of sheet flows.

### Conditions Where Practice Applies

Stone filter berms are most often used as a means of temporary sediment control. However, they are a more permanent alternative to silt fence, straw bales or brush barriers and do a better job of resisting the effects of heavy water flow, wind and heavy sediment loads. They are very effective in trapping sediment and are often installed above larger sediment control structures to decrease the frequency of clean-out maintenance.

In some cases, stone filter berms may be used to provide adequate long-term sediment control below drainage areas less than 5 acres in size. Stone filter berms may also double as safety berms along elevated haulroads, particularly where they cross streams or run beside sediment control structures.

### Design Criteria

No formal design criteria are required for stone filter berms. However, the location of the structure must be shown on the permit map and construction, maintenance, and abandonment plans should be detailed in the permit operations narrative.

Stone filter berms should be used:

1. Where disturbed areas are only subject to sheet or rill erosion.
2. Where effective sediment control is required for an extended period of time.
3. Where the disturbed area does not extend back from the structure more than 300 feet.

4. Where supplemental sediment control is needed to reduce sedimentation in permanent sediment control facilities.

Stone filter berms should not be used:

1. In flowing streams or areas of concentrated flow.
2. Where runoff may concentrate in defined ditches, except where temporary structures are used to provide sediment control while more permanent sediment controls are constructed.
3. Where rock or other hard surfaces prevent the full and uniform anchoring of the barrier and its filter medium.

### **Construction Specifications**

1. Stone filter berms should be installed at least 5 to 7 feet from the base of a disturbed slope. This allows room for sediment accumulation.
2. Stone filter berms should be at least 2 feet high and should be constructed of either a mix of VDOT #3's and #57's or Class I riprap faced with one foot of VDOT #57's. Heavier stone is needed where greater flows are anticipated. To increase effectiveness, filter fabric should be placed between the coarse and small aggregate layers.

### **Maintenance**

1. Stone filter berms shall be inspected immediately after each rainfall and at least daily during prolonged heavy rainfall. Any required repairs shall be made immediately.
2. Sediment deposits should be removed when deposits reach approximately one-half the height of the barrier. If the voids in the filter stone become filled and the structure impedes water flow, the stone should be replaced.

### **Abandonment**

Stone filter berms may be removed when they have served their usefulness, but not before the up slope areas have been permanently stabilized.

Any sediment deposits remaining in place after the filter berm is no longer required shall be dressed up to conform to the existing grade and seeded.

Depending on the post mining use of the property and the location, the filter berm may be left to deteriorate naturally.

## **7.10 TEMPORARY SEDIMENT CONTROL**

A temporary sediment barrier constructed of porous filtering materials and usually installed at the perimeter of the disturbed area. Straw bale barriers, brush barriers, and silt fence are considered temporary sediment controls.

### **Purpose**

1. To prevent sediment from leaving disturbed areas.
2. To decrease the velocity of sheet flows.

## Conditions Where Practice Applies

Some form of sediment control shall be installed prior to all land disturbing activities. In most cases, the first land disturbing activity on a construction project is the construction of diversions and sediment traps, channels or basins. Large areas may be disturbed and subject to erosion while the approved sediment control device is being constructed. Temporary sediment controls such as straw bale barriers, silt fence, or brush barriers should be installed around the lower perimeter of these construction projects to provide sediment control until they are completed.

In some cases, where disturbed areas are small and construction timeframes are very short, temporary sediment controls may be the only sediment control necessary. In those cases, it is very important that construction remain on schedule and steps be taken to establish a vegetative cover as soon as grade work is complete.

## Design Criteria

No formal design criteria are required for temporary sediment control measures. However, the location of the structure must be shown on the permit map and construction, maintenance, and abandonment plans should be detailed in the permit operations narrative.

Temporary sediment controls should be used where:

1. Disturbed areas are only subject to sheet or rill erosion.
2. Effective sediment control is only required for a period of 90 days or less.
3. The disturbed area does not extend back from the structure more than 200 feet.
4. Supplemental sediment control is needed to reduce sedimentation in permanent sediment control facilities.

Temporary sediment controls should not be used:

1. In flowing streams or areas of concentrated flow.
2. Where water may concentrate in defined ditches, except when such temporary structures are used to implement sediment control while more permanent sediment controls are constructed.
3. Where rock or other hard surfaces prevent the full and uniform anchoring of the barrier and its filter medium.

## Silt Fence

Silt Fence is a temporary sediment barrier consisting of a synthetic filter fabric stretched between and attached to supporting posts. The bottom portion of the fabric is buried in an excavated trench to form a seal between the fence and the ground surface.

Silt fence may be of three varieties:

1. Standard strength filter fabric supported by posts and wire mesh.

2. Extra strength filter fabric supported between posts with no wire mesh reinforcement. Extra strength filter fabric normally has reinforcing fibers permanently bonded in the fabric.
3. Prefabricated silt fence. Prefabricated silt fence is purchased with the filter fabric already attached to wooden or metal stakes uniformly spaced along the length of the material. Varying fence heights and lengths are available.

### **Construction Specifications**

1. Silt fence should be installed at least 5 to 7 feet from the base of a disturbed slope. This allows room for sediment accumulation.
2. Synthetic filter fabric shall be a permeable sheet of propylene, nylon, polyester, or ethylene yarn containing stabilizers and ultraviolet ray inhibitors, which insure a useable construction life of at least 6 months.
3. Filter fabric having a minimum tensile strength of 30-lbs./linear inch shall be reinforced with wire fence with maximum mesh spacing of 6 inches. (Figure 7-24)
4. Filter fabric having a minimum tensile strength of 50-lb./linear inch may be fastened directly to posts without wire fence reinforcement. (Figure 7-25)
5. Wooden or metal stakes may be used to support the fabric. These supports must be of suitable size, height, and spacing to support the anticipated loads.
6. The height of the silt fence shall be at least 16 inches above the original ground and no more than 34 inches above ground elevation.
7. A trench shall be excavated approximately 4 inches wide and 4 inches deep on the upslope side of the proposed location of the fence.
8. Where wire support is used with standard strength filter fabric, posts shall be placed a maximum of 10 feet apart. The wire mesh must be fastened to the upslope side of the posts using heavy-duty wire staples, tie wires, or hog rings. The wire shall extend into the trench a minimum of 2 inches. The filter fabric shall be stapled or wired to the wire fence and 8 inches of the fabric shall be extended into the trench.
9. When wire support is not used, extra strength filter fabric shall be used. Posts for extra strength fabric shall be placed a maximum of 6-feet apart. The filter fabric shall be fastened securely to the upslope side of the posts using one-inch long (minimum) heavy-duty wire staples or tie wires and 8 inches of the fabric shall be extended into the trench.
10. The 4-inch by 4-inch trench shall be backfilled and the soil compacted over the filter fabric.

Figure 7-24: Construction of a Silt Fence (with Wire Support)

## CONSTRUCTION OF A SILT FENCE (WITH WIRE SUPPORT)

1. Set posts and excavate 4"x4" trench upslope along the line of posts.

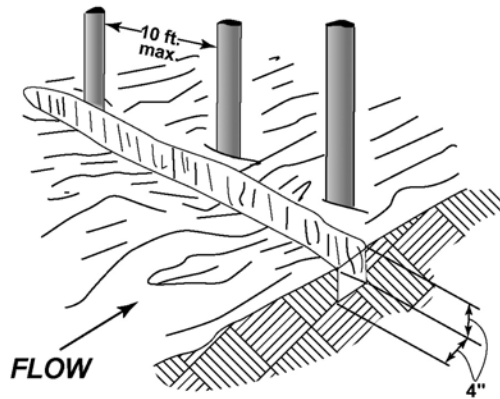

2. Staple wire fencing to the posts.

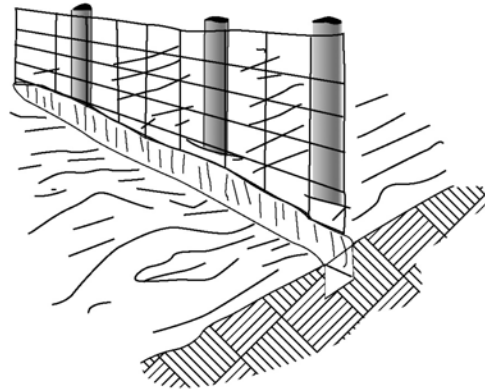

3. Attach the filter fabric to the wire fence and extend it into the trench.

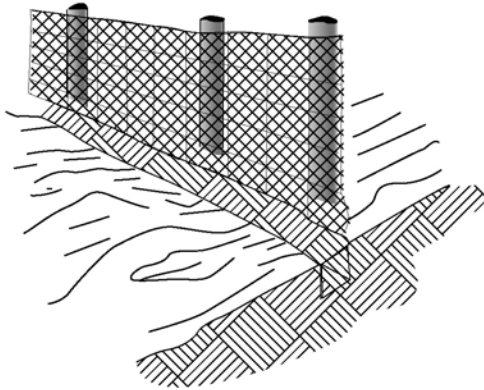

4. Backfill and compact the excavated soil.

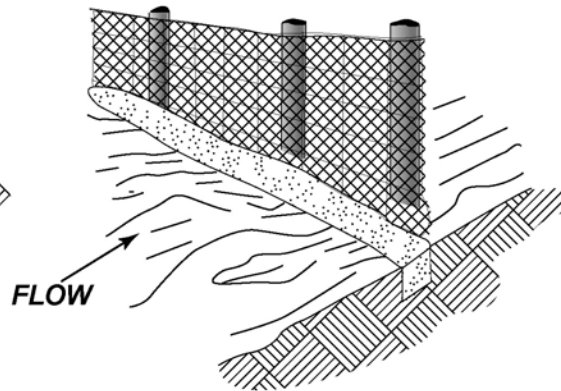

Extension of fabric and wire into the trench.

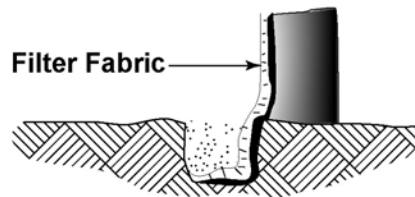

Source: Adapted from *Installation of Straw and Fabric Filter Barriers for Sediment Control* Sherwood and Wyant

Figure 7-25: Construction of a Silt Fence (without Wire Support)

## CONSTRUCTION OF A SILT FENCE (WITHOUT WIRE SUPPORT)

1. Set the stakes.

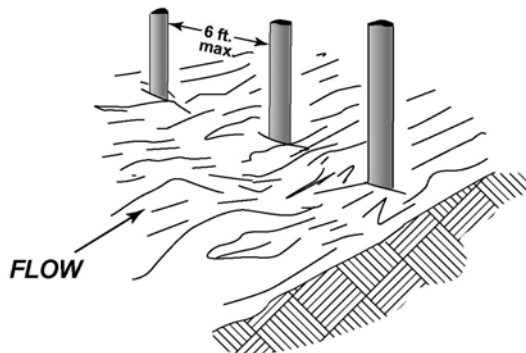

2. Excavate a 4" x 4" trench upslope along the line.

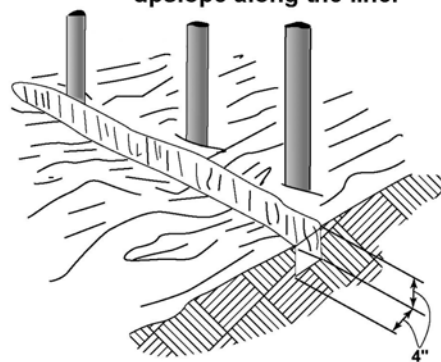

3. Staple filter material to stakes and extend it into the trench.

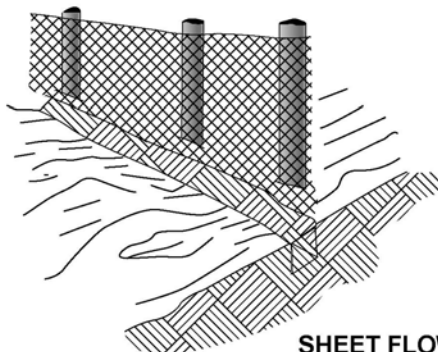

4. Backfill and compact the excavated soil.

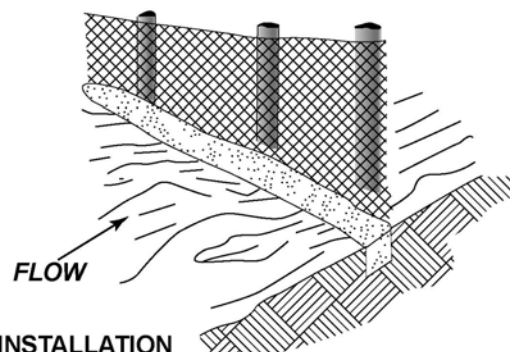

SHEET FLOW INSTALLATION  
(PERSPECTIVE VIEW)

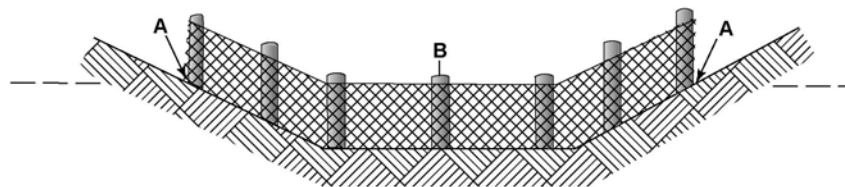

Points A must be higher than point B.  
DRAINAGEWAY INSTALLATION  
(FRONT ELEVATION)

Source: Adapted from *Installation of Straw and Fabric Filter Barriers for Sediment Control* Sherwood and Wyant

## **Maintenance**

1. Silt fences shall be inspected immediately after each rainfall and at least daily during prolonged rainfall. Any required repairs shall be made immediately.
2. Close attention shall be paid to the repair of damaged silt fence resulting from end runs and undercutting.
3. Should the fabric on a silt fence decompose or become ineffective while the barrier is still necessary, the fabric shall be replaced promptly.
4. Sediment deposits should be removed after each storm event. They must be removed when deposits reach approximately one-half the height of the barrier.

## **Abandonment**

1. Silt fences shall be removed when they have served their useful purpose, but not before the upslope area has been permanently stabilized. Silt fence shall be properly disposed of on-site or in an approved landfill.
2. Any sediment deposits remaining in place after the silt fence is no longer required shall be dressed to conform to the existing grade and seeded.

## **Straw Bale Barrier**

A temporary sediment barrier constructed of straw bales aligned in a continuous row. The bales are placed in a shallow trench to ensure full ground contact and anchored in place by wood or metal stakes.

## **Construction Specifications**

1. Straw bale barriers should be constructed at least 5 to 7 feet from the base of a disturbed slope to allow space for sediment accumulation. (Figure 7-26)
2. Bales shall be placed in a single row, lengthwise on the contour, with ends of adjacent bales tightly abutting one another.
3. All bales shall be either wire-bound or string-tied. Straw bales shall be installed so that bindings are oriented around the sides rather than along the tops and bottoms of the bales in order to prevent deterioration of the bindings.
4. The barrier shall be entrenched and back filled. A trench shall be excavated the width of a bale and the length of the proposed barrier to a minimum depth of 4 inches.
5. Each bale shall be securely anchored by at least two (2 inches x 2 inches x 36 inches) wooden stakes or two standard "T" or "U" steel stakes driven through the bale. Stakes shall be securely driven into the ground to anchor the bales.
6. The gaps between bales shall be chinked (filled by wedging) with straw to prevent water from escaping between the bales. Loose straw scattered over the area immediately uphill from a straw bale barrier tends to increase barrier efficiency.

Figure 7-26. Straw Bale Barrier

## STRAW BALE BARRIER

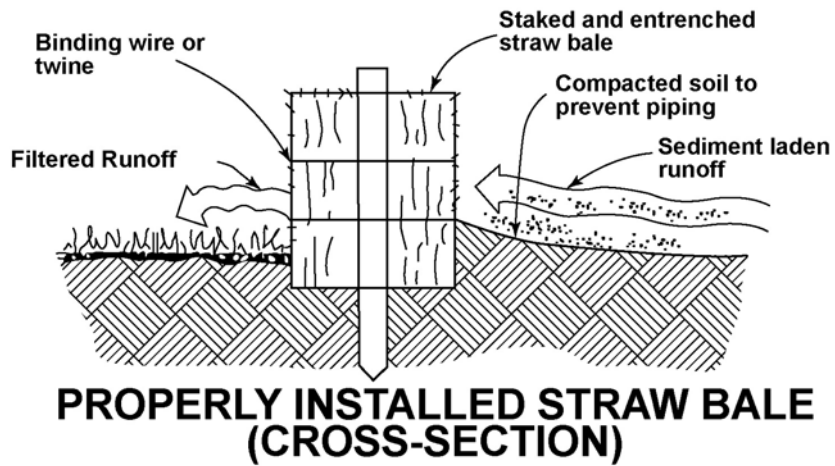

1. Excavate the trench.

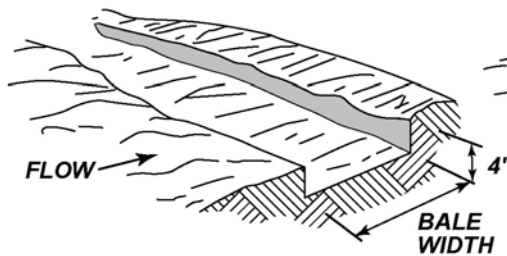

2. Place and stake straw bales.

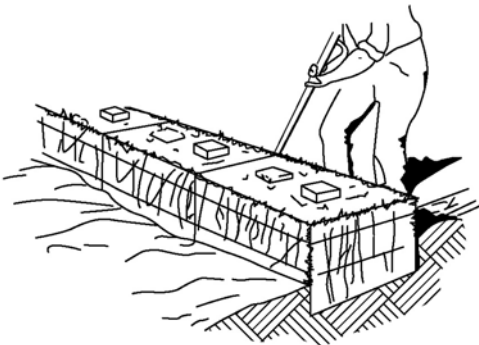
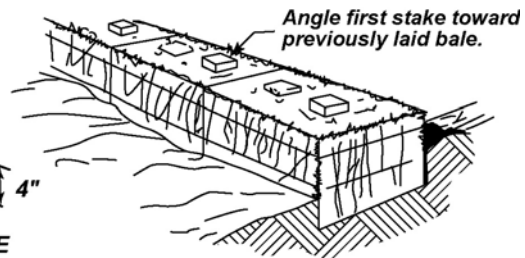

3. Wedge loose straw between bales.

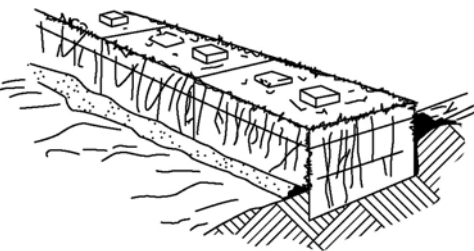

4. Backfill and compact the excavated soil.

## CONSTRUCTION OF STRAW BALE BARRIER

Source: VA DSWC



7. Excavated soil shall be back filled against the barrier. Back fill soil shall conform to the ground level on the downhill side and shall be built up to 4 inches against the uphill side of the barrier.

### **Maintenance**

1. Straw bale barriers shall be inspected immediately after each rainfall and at least daily during prolonged rainfall.
2. Close attention shall be paid to the repair of damaged bales, end runs, and undercutting beneath bales.
3. Necessary repairs to barriers or replacement of bales shall be accomplished promptly.
4. Sediment deposits should be removed after each rainfall. They must be removed when the level of deposition reaches approximately one-half the height of the barrier.

### **Abandonment**

1. Straw bale barriers shall be removed when they have served their usefulness, but not before the up slope areas have been permanently stabilized.
2. Any sediment deposits remaining in place after the straw bale barrier is no longer required shall be dressed to conform to the existing grade and seeded.

### **Brush Barrier**

A temporary sediment barrier constructed of filter fabric, brush and woody plant material removed from the site during clearing and grubbing operations. The brush is winnowed along the contour below the disturbed area and covered with entrenched filter fabric on the uphill side. Refer to Figure 7-27 for the following construction specifications.

### **Construction Specifications**

1. The height of a brush barrier should be at least 2 feet.
2. The width of a brush barrier should be at least 3 to 5 feet.
3. The brush placed in the barrier should be capable of providing adequate support for the filter fabric. Large stumps and tree trunks (>6" dia.) should be properly disposed of by other means.
4. Synthetic filter fabric, with a tensile strength of 30-50 lb./linear inch shall be used. Filter fabric shall be a permeable sheet of propylene, nylon, polyester or ethylene yarn, and shall contain stabilizers and ultraviolet ray inhibitors, which insure stability of the fabric for the useable life of the structure.
5. A trench shall be excavated 4 inches wide and 4 inches deep along the length of the barrier and immediately uphill from the barrier.
6. The filter fabric shall be cut into lengths sufficient to lie across the barrier from its up-slope base to just beyond its peak. Where joints are necessary, the fabric shall be spliced together with a minimum 6-inch overlap and securely sealed.

**Figure 7-27: Construction of a Brush Barrier Covered by Filter Fabric (Tree/Residual Material with Diameter < 6")**

## **CONSTRUCTION OF A BRUSH BARRIER COVERED BY FILTER FABRIC**

**(TREE/RESIDUAL MATERIAL WITH DIAMETER < 6")**

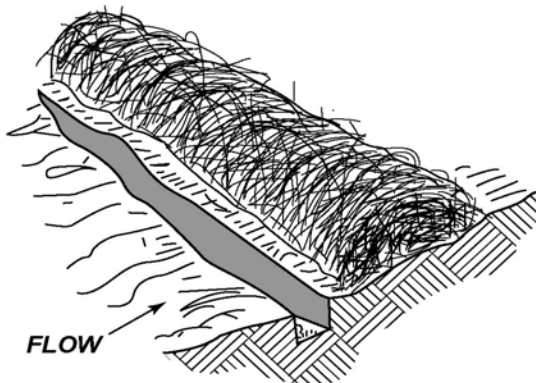

- 1. Excavate a 4"x4" trench along the uphill edge of the brush barrier.**

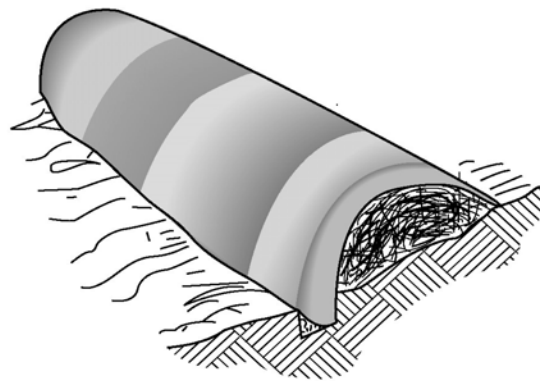

- 2. Drape filter fabric over the brush barrier and into the trench. Fabric should be secured in the trench with stakes set approximately 36" O.C.**

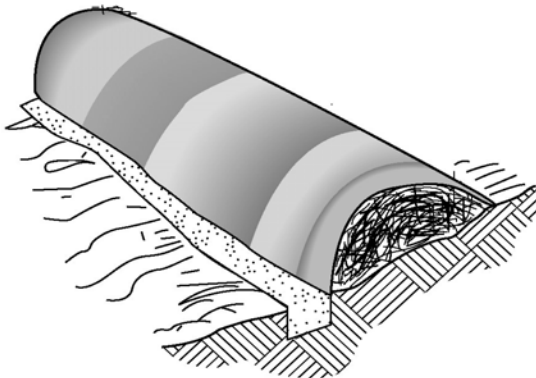

- 3. Backfill and compact the excavated soil.**

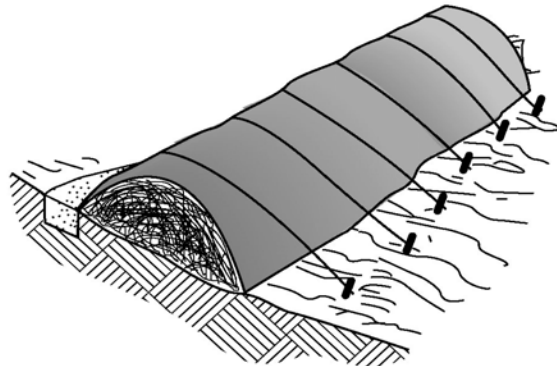

- 4. Set stakes along the down hill edge of the brush barrier, and anchor by tying twine from the fabric to the stakes.**

Source: VA DSWC

7. The lengths of filter fabric shall be draped across the width of the barrier with the uphill edge placed in the trench and the edges of adjacent pieces overlapping each other.
8. The filter fabric shall be secured in the trench with stakes set approximately 36 inches on center.
9. The trench shall be backfilled with soil compacted over the fabric.
10. The filter fabric should be anchored to the crest of the brush barrier by tying twine from the fabric to stakes or tree limbs secured within the down slope side of the barrier.

### **Maintenance**

The brush barrier shall be inspected after each rainfall and necessary repairs shall be made promptly.

Sediment deposits must be removed when they reach approximately one-half the height of the barrier.

### **Abandonment**

Brush barriers may be removed when they have served their usefulness, but not before the up slope areas have been permanently stabilized.

Any sediment deposits remaining in place after the brush barrier is no longer required shall be dressed up to conform to the existing grade and seeded.

Filter fabric must be properly disposed of on-site or in an approved landfill.

Depending on the post mining use of the property and the location, the brush may be left to deteriorate naturally.

## **7.11 HEAVY METALS**

This form of chemical pollution is caused by exposing minerals to oxidation or leaching, resulting in considerable concentrations of dissolved materials. The primary result of the oxidation of pyritic material is the formation of acids, which may in turn selectively extract heavy metals that are present in trace quantities in mineral and soil formations.

Probably the most effective means of control is to limit the exposure time by uncovering or disturbing the smallest area possible. Water contact with pyritic materials can also be reduced by the use of berms, dikes, and diversions. As pointed out earlier, these same practices are used in the control of sediment but here they take on a different connotation; that of improving water qualities by preventing the formation of acidic or heavy metal solutions in runoff.

A much more positive approach is to separate all acid-producing and/or toxic overburden spoil with a pH less than 4.0 as the material is mined. These toxic materials should be placed in mined-out pits or other approved fill areas and covered with a minimum of four (4) feet of soil that will support vegetation.

Surface permeability of pollution forming materials can be reduced by proper placement of impervious materials such as concrete, soil cement, asphalt, rubber, plastic, latex, and clay.

These materials are applied in a layer on the pollution forming material to form a watertight seal. The same effect can be achieved by surface compaction and by chemical surface treatments such as carbonate bonding.

There are a number of methods to treat mine drainage waters containing heavy metals. Neutralization, ion exchange, reverse osmosis, electro-dialysis, and flash distillation are among the methods used. Many of these methods require special equipment to adjust the water quality to the level required. Neutralization of acid mine water with crushed limestone is a treatment worthy of mention. The use of crushed limestone is generally the least expensive source per ton of needed basicity. The EPA and others have indicated that limestone treatment and the combination of limestone and lime treatment offers advantages in neutralization in that they produce a low volume, high-density sludge at a relatively low cost. The process does have limitations when trying to neutralize drainage containing large amounts of  $\text{Fe}^{+2}$ .

## **8 GENERAL FENCING SPECIFICATIONS FOR STANDARD WOVEN WIRE FENCE**

### **8.1 MATERIALS**

#### **Fence Fabric**

Woven Wire fence fabric should conform to ASTM A116 for Design Number 1047-6-11 for Class 3 galvanized wire with six-inch stay spacing and 47 inch height fence.

#### **Posts**

Line post should be either galvanized flanged "U" or "T" type with a minimum weight of 1.25 pounds per foot and with a minimum of five clamps for attaching fence fabric.

Corner and Line Brace Posts should be either galvanized L2-1/2 X2-1/2 x 1/4 with L 2x2x3/16 braces, or galvanized 2-1/2 OD pipe with 1-5/8" OD braces.

Gateposts should be 4" OD galvanized pipe.

#### **Barbed Wire**

Barbed wire should be double stranded, 12-1/2 gauge with four-point barbs on approximately five-inch centers and conforming to ASTM A585, Type 1 with 0.3-oz/sq. ft. of aluminum coating.

#### **Fitting and Supports**

Fitting and supports should be galvanized in accordance with ASTM A123 or A153, as applicable.

#### **Concrete**

Concrete should be Class A, 3000-PSI mix design, or high strength, quick-set grout, where applicable.

#### **Danger Signs**

Danger Signs should be fabricated from steel or aluminum sheet with red background (film or painted) and with two-inch black letters (film or painted) in block format for the message. Each sign should have at least two holes suitably located for mounting to fence fabric. Sign materials and fabrications should be warranted for at least five years against fading, cracking and peeling. Message should read: **"DANGER KEEP OUT"**

### **8.2 GENERAL**

The fence lines should be staked out. All utility lines and services should be located and preserved. An area approximately 10 feet wide along the proposed fence line should be cleared for equipment access to provide a level surface to install the fence. All construction debris should be picked up and lawfully disposed of off the property at the conclusion of each workday.

## **Posts**

Line posts should be installed on eight and 12 foot (maximum) increment spacing (as specified) with a minimum ground depth of 36 inches. Line brace posts should be installed on 500 feet maximum spacing, adjacent to water gates and fence gates, and whenever the fencing vertical alignment changes 15 degrees or more. Corner braces should be installed whenever the corner angle is 15 degrees or more.

Line post should be driven in place in a manner so as not to damage the post. In the event rock is encountered before reaching the specified depth, line posts should be set in concrete or high-strength grout at least 18 inches into rock. The post must still have a minimum ground depth of 36". The diameter of holes prepared for setting post in rock should be at least three inches greater than the larger cross-sectional dimension of the post. All concrete footings should have tops crowned at ground level. Except as otherwise approved, concrete should set for at least seven days before installation of wire fabric. Any posts that are misaligned, bent or broken during installation should be immediately replaced. Fence posts should be installed and aligned such that the tops form a neat and regular grade line.

## **Wire Fabric**

Wire fabric should be stretched taut with the top and bottom strands and at least three horizontal strands of the fence fabric securely attached to each post with 11 gauge galvanized steel wire or seven gauge aluminum wire clamps. Fence fabric should be installed approximately three inches above the ground on the exterior side of posts. Splicing should only be permitted at the posts. Each horizontal strand of wire should be wrapped around the post and securely fastened by winding it about the wire leading to the post. Barbed wire should be stretched taut and securely attached to each post. Provide and install "Danger" signs securely attached to the fencing at approximately every 75 feet apart. (Figure 8-1)

## **Work Site Damages**

Any damage to existing utilities, structures and surfaces resulting from this work shall be repaired.

## **Final Inspection**

A final inspection of the fence work to verify compliance with these specifications should be made. Any deficiencies should be promptly and permanently corrected.

Figure 8-1: Standard Fence Woven Wire Fabric

REVISED ON 7/04

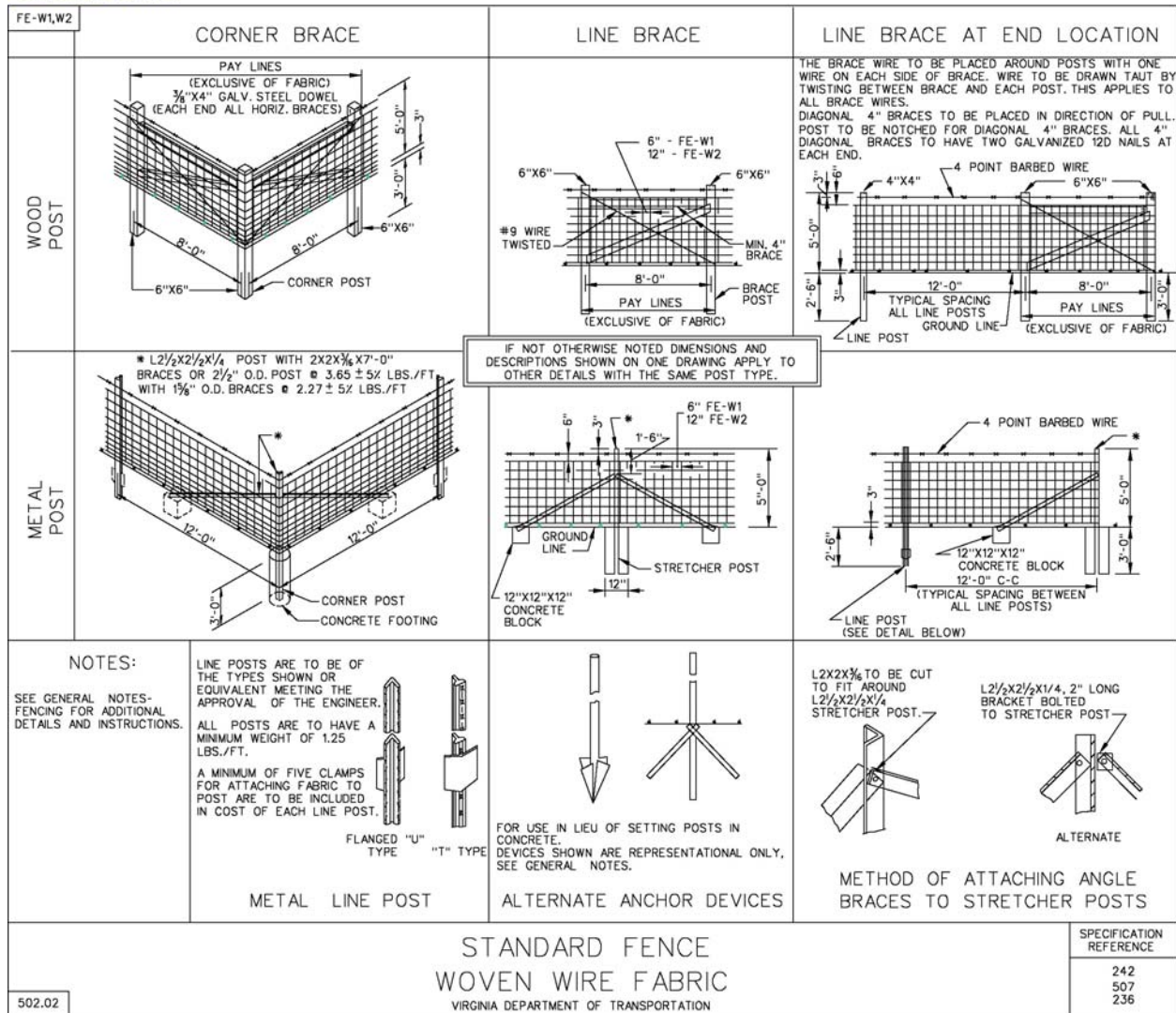

Source: VDOT Road and Bridge Standards, 2001

This page intentionally left blank.



## 9 ROADWAYS

### 9.1 DEFINITION

Any road, located within the mine permit area, that is constructed or improved for the transportation of personnel, equipment or materials.

### 9.2 PURPOSE

To provide a route for access to permit areas and for moving equipment, supplies, and materials within the permit area.

### 9.3 CONDITION WHERE PRACTICE APPLIES

This section describes design and construction practices to control runoff, sediment and dust originating from roadways. These practices apply to permitted access roads and internal service roads that may impact areas outside the permit area.



### 9.4 DESIGN CRITERIA

Principal access roads and internal service roads should be planned, constructed and maintained to minimize the impact of traffic, vehicle noise, runoff and dust on areas beyond the permit.

#### Road Surface

Access roads and internal service roads should be paved with an approved all-weather surface capable of stabilizing the road. Access roads that intersect public roads should be paved with an approved all-weather surface capable of preventing the deposition of mud or debris onto the public road. Where possible, access roads should enter public roads at an uphill grade with drainage directed back to sediment controls within the permit area. All-weather surfacing may consist of asphalt, concrete, crushed stone, or sand and gravel. Roads should not be surfaced with any acid producing material or any material that may produce a high concentration of dust or suspended solids in adjacent drainageways. Highway entrance permits must be obtained from the appropriate authority and installed in accordance with the approved permit.

When crossing areas of soft ground, geotextiles may be used to improve road stability. There are a number of geotextile products manufactured for use in road construction. When used under road surfacing materials, these fabric underlayments spread out the load of passing equipment and help prevent sinking and rutting of road surfacing materials. The geotextile should extend under the entire width of the road and should not surface where it could be snagged by road maintenance equipment.

Basic criteria for the design of road cross sections is listed below and shown in Figure 9-1. Numbers correspond with those shown in the cross sections.

Figure 9-1: Typical Haulage Way Sections

## TYPICAL HAULAGEWAY SECTIONS

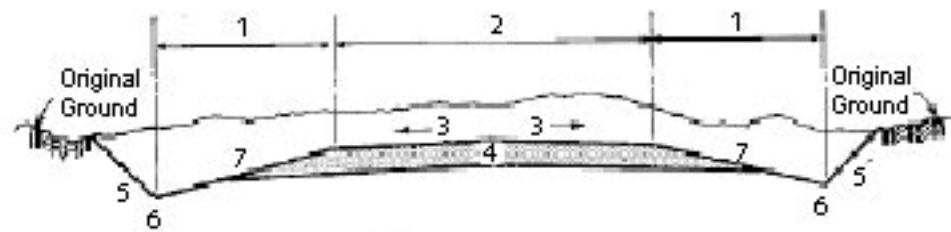

TYPICAL CUT SECTION

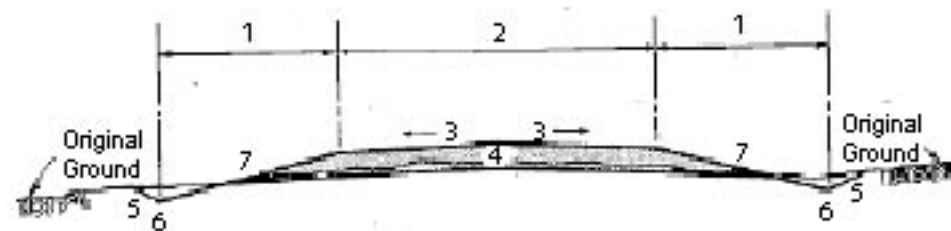

TYPICAL FILL SECTION

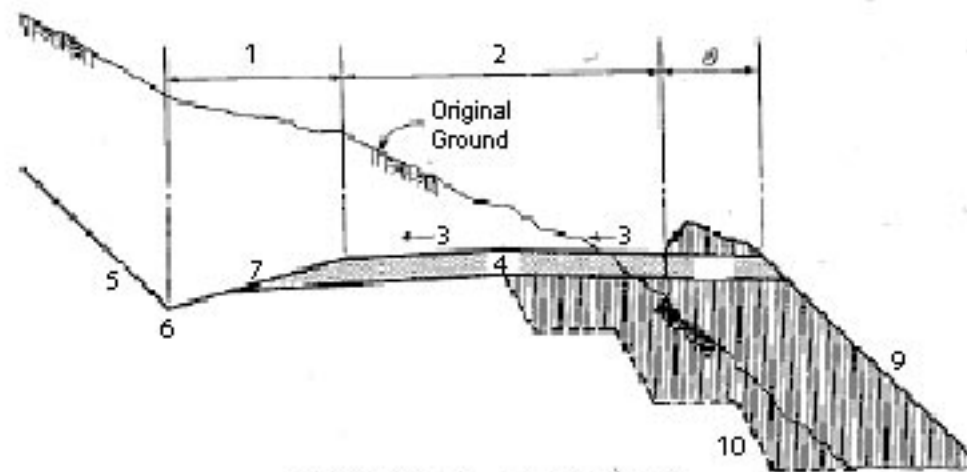

TYPICAL CUT - FILL SECTION

KEY

- 1 Lane edge to center line of ditch
- 2 Lane width
- 3 Typical cross slope for excavated subgrade and road surface
- 4 Combined surface and subbase
- 5 Ditch outslope
- 6 Depth at center line of ditch
- 7 Ditch slope adjacent to roadway
- 8 Safety berm
- 9 Fill slope
- 10 Fill bench

Source: USBM IC 8758

1. Lane edge to centerline of ditch. Dimensions will vary with the centerline depth (6) and required slope (7). Adequate shoulder width and slope should be provided to ensure that drainage within the ditchlines does not contact and soften road surfaces.
2. Lane width. This should be based on the dimension of the largest vehicle and the number of travel lanes desired. A single lane road should be twice the width of the largest vehicle. Dual lane roads should be 3 ½ times the size of the largest vehicle to allow half a vehicle width on both sides of passing vehicles.
3. Typical cross slope for excavated sub grade and road surface. The grade from the road centerline should be either ¼ or ½ inch per foot, depending on the surface material used. Roads that require safety berms on their outer edge should be banked away from the berm to their inside edge.
4. Combined surface and sub base. The depth of surfacing will ultimately depend on the required wheel loads and bearing capacity of the soil beneath the road. At a minimum, the road surface should consist of six inches of coarse rock base and two inches of fine crushed rock surface. Skimping on the amount of surfacing during road construction will only lead to additional material being applied during subsequent, and often, frequent maintenance.
5. Ditch outslope. In rock, this may approach a vertical slope. In less consolidated material, a 2:1 slope should be used.
6. Depth at centerline of ditch. The depth of ditches must be sufficient to handle the runoff from adjacent watersheds and ensure that the drainage within the ditch does not contact and soften road surfaces. The depth of the ditch below the sub base should be equal to the total depth of runoff anticipated within the ditch. In cut sections, drainage should be carried on both sides of the road.
7. Ditch slope adjacent to roadway. The slope of the ditch adjacent to the roadway should be 4:1 or flatter except in extreme restrictive conditions. It should not exceed a 2:1 slope.
8. Safety berm. Safety berms should be constructed with near vertical slopes on the inside of the road. The final height and outslope of the berm will depend on the rolling radius of the largest tires to traverse the road, the grade of the road, anticipated vehicle speeds and the type of material available to construct the berm. At a minimum, the completed berm should be mid-axle height on the largest vehicle to travel the road.
9. Fill slope. Fill material may be obtained from cut portions of the road or other excavated material from the mining operation. It should be select material, free from large rocks, roots or other debris and excessive moisture. The use of saturated or poorly drained material may result in slope failure under load. Fill material should be sloped to a maximum grade equal to the angle of repose.
10. Fill bench. Benching prior to fill placement is required whenever the slope of original ground is 1:1 or steeper. Benches should be cut eight to 10 feet wide and eight to 10 feet deep with cut slopes on 0.5:1 grade or steeper. Terracing should begin at the toe of the slope in original ground and continue uphill until the road sub grade is reached.

When roads are abandoned, immediate steps shall be taken to minimize erosion and establish the post-mining use in accordance with the approved reclamation plan. This

normally requires that the road surface be scarified to a depth of 12 inches or more, covered with six inches of topsoil and be planted to meet the approved post-mining land use. The road may be left un-reclaimed for post-mining access to the affected property as long as it is in a stable, well-maintained condition and approved as part of the post-mining land use.

### **Drainage and Sediment Control**

Good drainage is necessary to insure the stability of roads. Standing water in rutted sections of a road will continue to soften the road and deepen the ruts with each pass of mobile equipment. Access roads and internal service roads should be banked or crowned to ensure positive drainage from their surface. Where it is impractical to bank or crown a road, water bars may be necessary to divert runoff to adjacent ditchlines.

Ditches, of sufficient capacity to control surface runoff, should be provided along roadways. For most situations, V-ditches are recommended due to their relative ease of design, construction and maintenance. Where possible, ditches should be located in undisturbed earth or rock. Due to its erodibility, they should not be located in fill material.

The capacity of ditches to handle runoff depends on their configuration, grade and the type of lining provided within the ditch. As a general rule, loose, porous linings on shallow grades will reduce flow rates and increase flow depths, thereby requiring larger ditches. Ditches should be at least one foot deep, as measured from the lowest point in the road surface adjacent to the ditch, and should be adequate to carry runoff from a 10-year storm event. Ditches excavated in earthen material should be stabilized with rock or vegetation and check dams should be utilized along steep sections of ditchlines to prevent their erosion. Ditches may be grass lined up to an eight percent slope, but geotextiles are necessary on grades steeper than three percent to provide extra stabilization. Culverts, slope drains or relief ditches shall be installed at appropriate intervals to prevent overloading of roadside ditches.

Sediment control shall be provided along all roads to minimize the amount of sediment that leaves the disturbed area. Appropriately sized sediment traps shall be installed and maintained at all ditch relief points to provide sediment control along the roadway. Sediment traps shall be installed at all four corners of stream crossings unless other steps are taken to provide drainage and sediment control.

When roads are constructed through heavy forest cover, additional consideration should be given to maintaining a dry running surface. Pines and deciduous trees, when in leaf, can produce significant amounts of shade and prevent adequate air flow. To maintain a dry running surface during the wet and cold seasons of the year, it may be necessary to extend the limits of clearing further than that necessary to construct the road and ditchlines. A good rule of thumb is to clear a right of way that is at least 1-½ times the width of the road and ditchlines.

### **Culverts**

Culverts should be used wherever necessary to facilitate drainage along roadways and prevent runoff from overloading ditches. As a rule, culvert spacing should not exceed the following limits.

1000 feet	on grades from 0 to 3 %
800 feet	on grades from 3 to 6 %
500 feet	on grades from 6 to 9 %
300 feet	on grades steeper than 9 %

Culverts should be sized to accept the maximum runoff from the watershed above them. (Table 9-1) Where possible, the pipe diameter should be large enough to accept the required flow without creating a backup at the pipe inlet. Figure 9-2 may be used to determine culvert size based on flow requirements. Flows in cubic feet per second on the left side of the chart should be read to their intersection with the solid diagonal line and then down to the corresponding minimum pipe diameter necessary to handle the flow. The corresponding diameter should be rounded up to the next largest manufactured culvert size to specify a pipe capable of handling the required flow. This is the minimum diameter pipe that will flow full without any water backup at the inlet. Where it is desirable to install smaller size culverts, the dashed lines on the chart may be used to size a pipe based on the amount of allowable headwater that may be created behind the pipe. Due to the problems that can be created by backing water up in ditchlines, the practice of creating inlet headwater is discouraged.

Culverts should be installed in accordance with the following: (Figure 9-3)

1. Culverts should be placed on a minimum grade of one percent to ensure free drainage. They should be bedded on firm material free from large rocks or soft spots that could cause damage to the culverts or uneven settling along their length. Particular care should be taken to ensure that culverts lay on the same grade relative to one another when connections need to be made between them.
2. Culverts lengths should be adequate to extend beyond the full width of backfill to ensure the ends are not accidentally covered.
3. Culverts should be covered by compacted, select fill, free from large rocks, roots or other debris, to prevent damage from equipment that will use the road. If multiple culverts are used, they should be separated by at least 12 inches of fill. Fill material should be carefully compacted around the culverts in lifts not exceeding eight inches. Care should be taken to ensure that connections between culvert sections are tight and properly made up without gaps. The minimum depth of cover placed over the culvert should be equal to one-half the diameter of the culvert, or 12 inches, whichever is greater.
4. The inlet end of the culvert shall be protected by a headwall of suitable material such as a manufactured flared end section, concrete retaining wall, sand bags, rock riprap, or other approved material.
5. The outlet end shall discharge onto an apron of rock riprap or other approved material capable of preventing soil erosion. When practical, the outlet end should be placed at the toe of fill material. If discharging onto a fill slope, drainage must be conveyed down the fill by pipe slope drain, rock slope drain, or other means to prevent erosion.
6. Culverts should not be less than 12 inches in diameter and should be adequate to carry runoff from a 10-year storm event.

**Table 9-1: Approximate Method of Determining Required Culvert Sizes by Talbot's Formula**

TALBOT'S LAW:  $A = C (a^3)^{1/4}$

WHERE: A = CROSS SECTIONAL AREA REQUIRED (FT<sup>2</sup>)  
C = TALBOT'S COEFFICIENT  
a = AREA DRAINED IN ACRES

<u>VALUES OF TALBOT'S COEFFICIENT</u>	<u>CROSS-SECTIONAL AREAS OF PIPE (FT<sup>2</sup>)</u>		
C = 1.0 (MOUNTAINOUS TERRAIN)	12" = 0.79	42" = 9.62	72" = 28.3
C = 0.6 TO 0.8 (HILLY TERRAIN)	18" = 1.78	48" = 12.6	84" = 38.5
C = 0.4 TO 0.5 (ROLLING TERRAIN)	24" = 3.14	54" = 16.0	96" = 50.3
C = 0.2 TO 0.3 (FLAT TERRAIN)	30" = 4.91	60" = 19.6	108" = 63.6
	36" = 7.07	66" = 23.8	120" = 78.5

APPROXIMATE CROSS-SECTIONAL AREA REQUIRED (FT<sup>2</sup>)

<u>ACRES DRAINED</u>	<u>MOUNTAINOUS TERRAIN (&gt;12%)</u>	<u>HILLY TERRAIN (8-12%)</u>	<u>ROLLING TERRAIN (4-8%)</u>	<u>FLAT TERRAIN (0-4%)</u>
1	1.0	0.7	0.45	0.3
2	1.5	1.2	0.75	0.4
3	2.3	1.3	1.0	0.5
4	2.8	2.0	1.3	0.7
5	3.3	2.3	1.5	0.8
6	3.8	2.7	1.7	1.0
7	4.3	3.0	1.9	1.1
8	4.8	3.4	2.2	1.2
9	5.2	3.6	2.3	1.3
10	5.6	4.0	2.5	1.5
15	7.6	5.4	3.4	1.9
20	9.5	6.7	4.3	2.4
25	11.1	7.8	5.0	2.8
30	12.8	8.9	5.8	3.2
35	14.4	10.1	6.5	3.6
40	15.9	11.1	7.2	4.0
45	17.4	12.2	7.8	4.4
50	18.8	13.2	8.5	4.7
75	25.5	17.9	11.5	6.4
100	31.6	22.1	14.2	7.9
150	42.9	30.0	19.3	9.3
200	53.2	37.2	24.0	13.3
300	72.1	50.0	32.4	18.0
400	89.4	62.6	40.2	22.3
500	105.7	74.0	47.6	26.4
600	121.2	84.8	54.5	30.4



Figure 9-2: Graph Showing Pipe Culvert Capacity

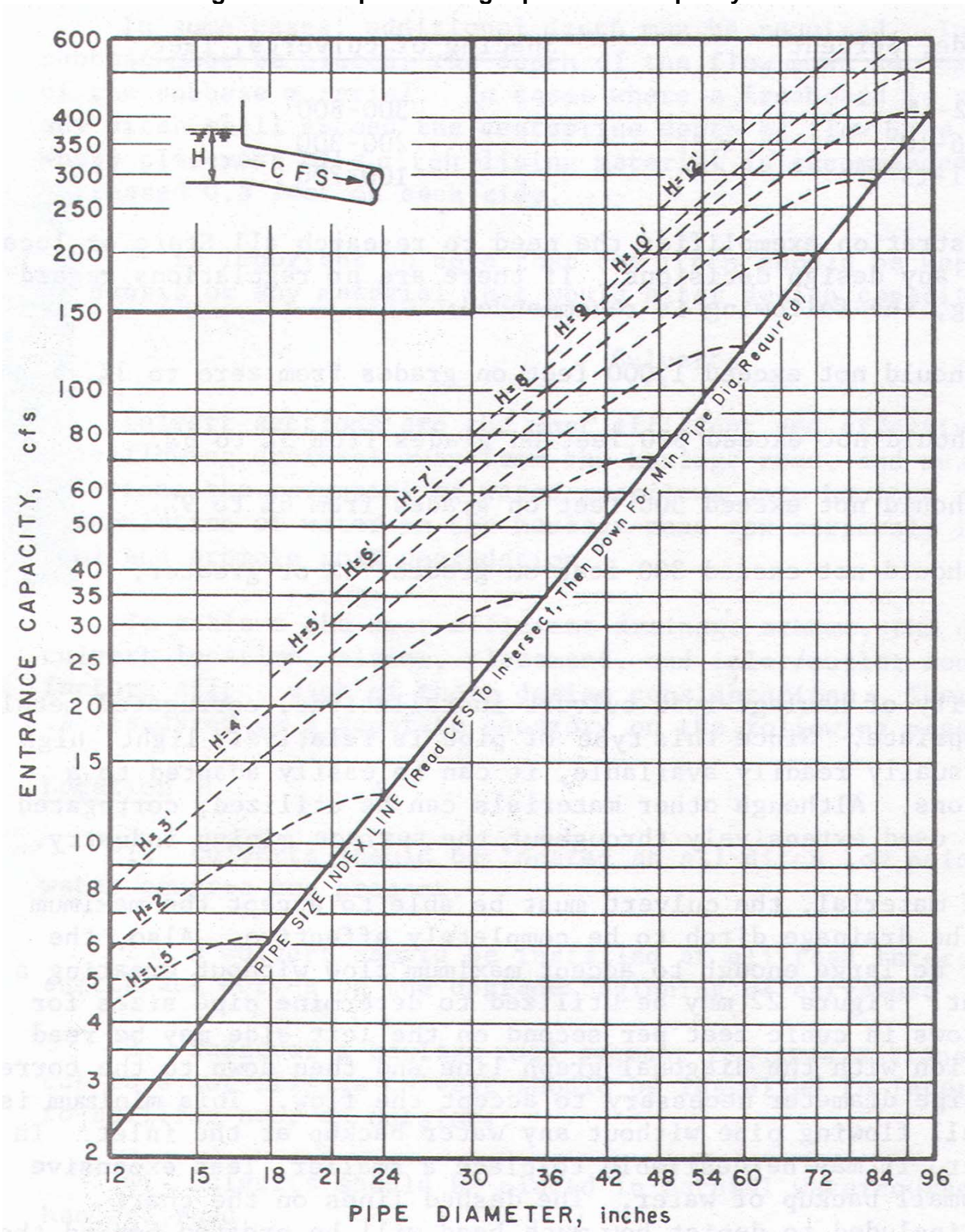

Source: USBM Information Circular 8758

**Figure 9-3: Typical Haulage Way Section Showing Installation of Ditch Relief Culvert**

**TYPICAL HAULAGEWAY SECTION  
SHOWING INSTALLATION OF DITCH RELIEF CULVERT**

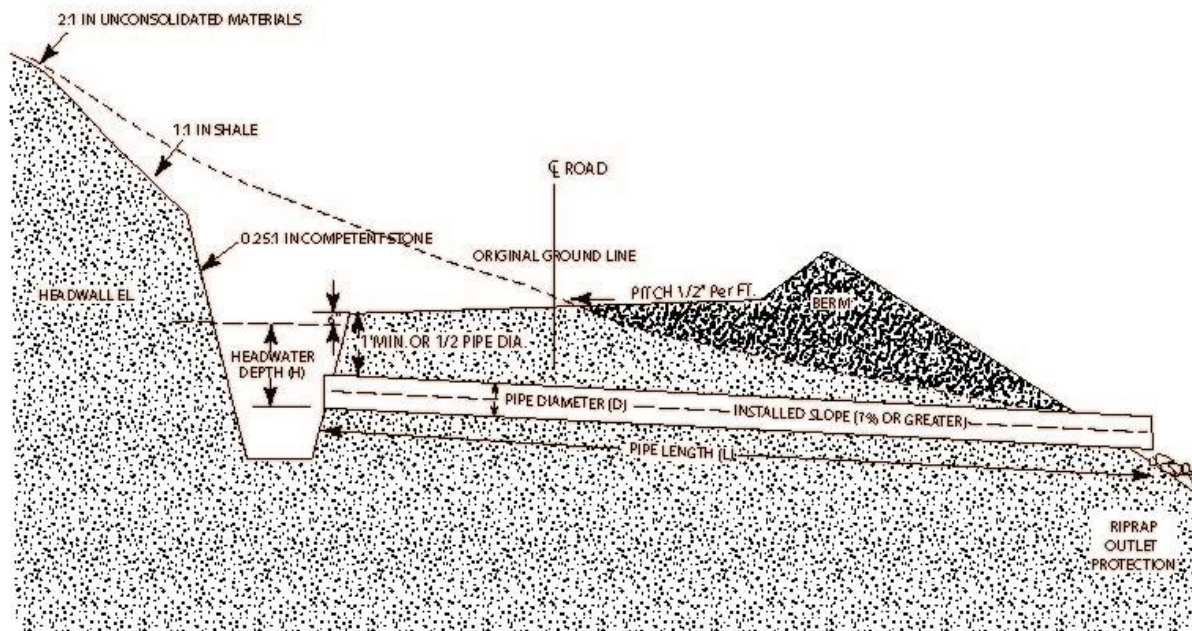

## Relation to Streams

### *Natural Drainageways*

Alteration or relocation of natural drainageways may be permitted if the integrity of the drainageway is maintained and adjoining landowners are protected from damage resulting from the alteration/relocation.

### *Stream Crossings*

Bridges or culverts are required in order to cross a stream channel. These structures shall be adequately designed and constructed to prevent stream flows from being restricted. See the Stream Crossing portion of this section.

### *Buffer Zone*

Roads shall be located away from streams wherever possible. A protective zone of undisturbed vegetation, at least 50 feet wide, should be provided, where feasible, between the road and stream to reduce the sediment load to the stream. As the steepness of the



slope increases, so should the width of the buffer zone. See the Buffer Zone portion of section 7.

## **Slopes**

Road cuts shall be sloped to minimize erosion and support a vegetative cover. Slopes should be completed on a grade not to exceed two horizontal to one vertical (2:1) in clayey soils. In sandy soils, slopes should be completed on grades not to exceed three horizontal to one vertical (3:1).

## **9.5 MAINTENANCE**

Maintenance is required to insure the proper functioning of the road and drainage system. Maintenance of the road system shall consist of inspecting, repairing and cleaning roadways, ditches, culverts and bridges, as often as necessary, to ensure their proper functioning. Particular attention should be given to removing debris from culvert inlets. Road surfaces shall be repaired and resurfaced with durable material where rutted, eroded or otherwise damaged.

## **9.6 Stream Crossings**

### **Definition**

A structural span installed across an intermittent or perennial watercourse for use by mine traffic. Structures may include round pipes, pipe arches, oval pipes or box culverts.

### **Purpose**

To provide a means for mine traffic to cross streams without damaging the channel or banks or tracking sediment or other pollutants into the stream.

### **Conditions Where Practice Applies**

Temporary Crossings: Generally applies to crossings that will remain in service during the life of the mining activity, or a fraction thereof.

Permanent Crossings: Applies to crossings that will remain in service during mining and will be utilized as part of the post mining land use.

### **Planning Consideration**

The specifications contained in this section pertain primarily to flow capacity and resistance to washout of the structure. The crossing should be adequate to convey runoff from the upstream watershed during its expected lifespan. From a safety and utility standpoint, the designer must also be sure that the span is capable of withstanding the expected loads from heavy equipment that will cross the structure. The structure should also be wide enough to accommodate the largest piece of equipment to use the crossing and allow adequate room for safety berms or guardrails.

### **Design Criteria**

A stream crossing may consist of circular pipes, pipe arches, oval pipes or boxes constructed of corrugated metal, structural plate, high-density polyethylene or reinforced concrete. Culverts are normally used where the channel is too wide for single span bridge

construction or the anticipated loading of vehicles may be unsafe for a single span bridge. Stream crossings should be installed in accordance with the following standards. (Figure 9-4)

1. Stream crossings should be constructed at right angles to the stream, wherever possible. Where approach conditions dictate, the crossing may vary 15° from the perpendicular. Wherever possible, the centerline of both roadway approaches should coincide with the crossing alignment centerline for a minimum distance of 50 feet from each bank of the stream. This will minimize wear and tear on the crossing as vehicles pass back and forth. When fill is required to build up the approach roadways, it should be limited to a maximum height of two feet above the flood plain elevation.
2. Culverts lengths shall be adequate to extend beyond the full width of backfill to ensure the ends are not accidentally covered.
3. All culverts should be strong enough to support their cross-sectional area under maximum expected loads.
4. Multiple culverts may be used in place of one large culvert if they have the equivalent capacity of the larger culvert. Culverts used to cross a stream should not be less than 18 inches in diameter.
5. Reinforced concrete headwalls should be used where backfill is likely to wash or where excessive flow velocities are encountered.

The crossing should be crested in its center and bermed along its sides to direct runoff down the road approaches. Water diverting structures or swales should be constructed across both roadway approaches within 50 feet of the crossing. The diversions should direct runoff from the road and stream crossing into properly sized sediment traps on both sides of the crossing. This method of grading the crossing will prevent water from building up on the crossing and will direct surface runoff into a sediment control structure before entering the waterway.

### **Construction Specifications**

1. Clearing and excavation of the streambed and banks should be kept to a minimum. The inlet and outlet ends of culverts should be installed on natural ground within the streambed to minimize interference with fish and animal movement along the stream. Culverts should not be buried in the streambed since that will decrease their flow capacity. However, it is important to ensure that the culverts are bedded on firm material free from large rocks or soft spots that could damage them or cause uneven settling along their length. Particular care should be taken to ensure that culverts lay on the same grade relative to one another when connections need to be made between them. Once initiated, construction shall be completed as soon as possible to minimize degradation of the stream channel. If possible, construction work should be scheduled to take advantage of periods of low flow.
2. Filter cloth should be placed on the streambed and stream banks prior to placement of culverts and aggregate necessary to construct the stream crossing. The filter cloth should cover the streambed and extend six inches to one foot beyond the end of the culverts and bedding material. The filter cloth will reduce fill material settlement and improve crossing stability.

Figure 9-4: Typical Stream Crossing

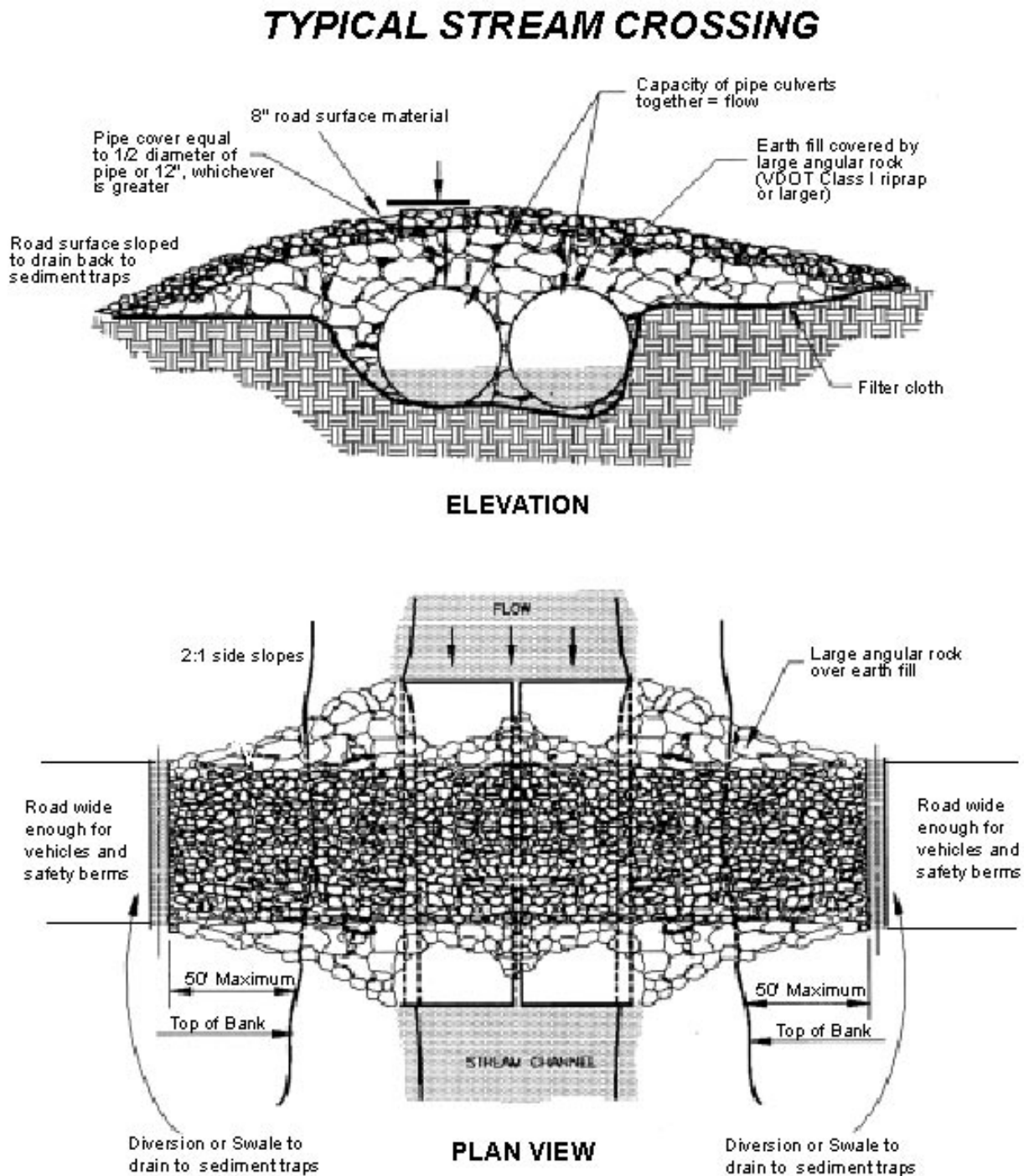

Source: VA Erosion and Sediment Control Handbook, 1992

3. The culverts should extend a minimum of one foot beyond the upstream and downstream toe of the aggregate used to stabilize the stream crossing. This is necessary to ensure that sloughing material does not cover the culvert ends.
4. Care should be taken to ensure that connections between culvert sections are tight and properly made up without gaps. If gaps form at connection points, backfill may erode through the gap and create cavities that will eventually lead to road failure.
5. Culverts should be covered by compacted, select fill, free from large rocks, roots or other debris, to prevent damage from equipment that will use the road. If multiple culverts are used, they should be separated by at least 12 inches of fill. Fill material should be carefully compacted around the culverts in lifts not exceeding eight (8) inches. Care should be taken to ensure that connections between culvert sections are tight and properly made up without gaps. The minimum depth of cover placed over the culvert should be equal to one-half the diameter of the culvert, or 12 inches, whichever is greater. Fill embankments should be completed on 2:1 grades. Class I riprap, or larger material, as appropriate, should be used to cover the crossing and protect the sides of the adjacent stream channel from erosion.
6. When a temporary crossing has served its purpose, and is no longer necessary, the culverts, bedding and filter cloth should be removed from the stream bed. It is normally best to remove a crossing in the reverse order of its construction, leaving removal of the culverts and adjacent headwall material for last. Whenever possible, the structure should be removed and the area cleaned-up without construction equipment entering the waterway. Once initiated, removal of the crossing should be completed as soon as possible to minimize degradation of the stream channel. Construction work should be scheduled to take advantage of periods of low flow. Upon removal of the structure, the stream channel should be reshaped to its original cross-section and stabilized with appropriately sized clean riprap. Stream banks should be vegetated with suitable grasses and shrubs.

### Manning's Formula to Determine Flow in Streams

Manning's Formula may be used to determine the quantity of water that must be carried by the culvert(s).

$$Q = VA$$

$$\text{Where: } V = \frac{1.486}{n} R^{2/3} S^{1/2}$$

Q = stream flow in cubic feet per second, f<sup>3</sup>/sec.

V = flow velocity, ft/sec.

A = cross sectional area of stream channel perpendicular to flow, ft<sup>2</sup>

R = hydraulic radius\*, ft (Table 9-2)

S = slope of the stream channel, ft/ft (Table 9-3)

n = Manning's "n" (coefficient of stream bed roughness) (Table 9-4)

$$\text{*hydraulic radius} = \frac{\text{area of waterway}}{\text{wetted perimeter}}$$

Example:

Given an existing waterway with a measured wetted perimeter = 24 ft., cross sectional area = 40 ft<sup>2</sup>, slope = 2 feet per thousand feet, a meandering channel with a few weeds in the channel and heavy brush on the banks.

Where  $Q = VA$

$$\text{and } V = \frac{1.486}{n} R^{2/3} S^{1/2}$$

$$R = \frac{A}{P} = \frac{40 \text{ ft}^2}{24 \text{ ft}} = 1.66 \text{ ft}$$

$$S = 0.02$$

$$n = 0.07$$

$$Q = (40 \text{ ft}^2) \frac{(1.486)}{(0.07)} (1.66 \text{ ft})^{2/3} (0.02 \text{ ft./ft.})^{1/2} = 40 \frac{(1.486)}{(0.07)} (1.402) (0.1414)$$

$$Q = 168 \text{ cfs}$$

Follow the procedure found in Section 7.6 of this document to determine the pipe size required to handle a stream flow = 168 cfs.

**Table 9-2: Values of R<sup>2/3</sup>**

Number	0.0	0.1	0.2	0.3	0.4	0.5	0.6	0.7	0.8	0.9
0.0	.000	.046	.074	.097	.117	.136	.153	.170	.186	.201
0.1	.215	.229	.243	.256	.269	.282	.295	.307	.319	.331
0.2	.342	.353	.364	.375	.386	.397	.407	.418	.428	.438
0.3	.448	.458	.468	.477	.487	.487	.506	.515	.525	.534
0.4	.543	.552	.561	.570	.578	.587	.596	.604	.613	.622
0.5	.630	.638	.647	.655	.663	.671	.679	.687	.695	.703
0.6	.711	.719	.727	.735	.743	.750	.758	.765	.773	.781
0.7	.788	.796	.803	.811	.818	.825	.832	.840	.847	.855
0.8	.862	.869	.876	.883	.890	.897	.904	.911	.918	.925
0.9	.932	.939	.946	.953	.960	.966	.973	.980	.987	.993
1.0	1.000	1.007	1.013	1.020	1.027	1.033	1.040	1.046	1.053	1.059
1.1	1.065	1.072	1.078	1.085	1.091	1.097	1.104	1.110	1.117	1.123
1.2	1.129	1.136	1.142	1.148	1.154	1.160	1.167	1.173	1.179	1.185
1.3	1.191	1.197	1.203	1.209	1.215	1.221	1.227	1.133	1.239	1.245
1.4	1.251	1.257	1.263	1.269	1.275	1.281	1.287	1.293	1.299	1.305
1.5	1.310	1.316	1.322	1.328	1.334	1.339	1.345	1.351	1.357	1.362
1.6	1.368	1.374	1.379	1.385	1.391	1.396	1.402	1.408	1.413	1.419
1.7	1.424	1.430	1.436	1.441	1.447	1.452	1.458	1.463	1.469	1.474
1.8	1.480	1.485	1.491	1.496	1.502	1.507	1.513	1.518	1.523	1.529
1.9	1.534	1.539	1.545	1.550	1.556	1.561	1.566	1.571	1.577	1.582
2.0	1.587	1.593	1.598	1.603	1.608	1.613	1.619	1.624	1.629	1.634
2.1	1.639	1.645	1.650	1.655	1.660	1.665	1.671	1.676	1.681	1.686
2.2	1.691	1.697	1.702	1.707	1.712	1.717	1.722	1.727	1.732	1.737
2.3	1.742	1.747	1.752	1.757	1.762	1.767	1.772	1.777	1.782	1.787
2.4	1.792	1.797	1.802	1.807	1.812	1.817	1.822	1.827	1.832	1.837
2.5	1.842	1.847	1.852	1.857	1.862	1.867	1.871	1.876	1.881	1.886
2.6	1.891	1.896	1.900	1.905	1.910	1.915	1.920	1.925	1.929	1.934
2.7	1.939	1.944	1.949	1.953	1.958	1.963	1.968	1.972	1.977	1.982
2.8	1.987	1.992	1.996	2.001	2.006	2.010	2.015	2.020	2.024	2.029
2.9	2.034	2.038	2.043	2.048	2.052	2.057	2.062	2.066	2.071	2.075
3.0	2.080	2.085	2.089	2.094	2.099	2.103	2.108	2.112	2.117	1.122
3.1	2.126	2.131	2.135	2.140	2.144	2.149	2.153	2.158	2.163	2.167
3.2	2.172	2.176	2.180	2.185	2.190	2.194	1.199	2.203	2.208	2.212
3.3	2.217	2.221	2.226	2.230	2.234	2.230	2.243	2.248	2.252	2.257
3.4	2.261	2.265	2.270	2.274	2.279	2.283	2.288	2.292	2.296	2.301
3.5	2.305	2.310	2.314	2.318	2.323	2.327	2.331	2.336	2.340	2.345
3.6	2.349	2.353	2.358	2.362	2.366	2.371	2.375	2.379	2.384	2.388
3.7	2.392	2.397	2.401	2.405	2.409	2.414	2.418	2.422	2.427	2.431
3.8	2.435	2.439	2.444	2.448	2.452	2.457	2.461	2.465	2.469	2.474
3.9	2.478	2.482	2.486	2.490	2.495	2.499	2.503	2.507	2.511	2.516
4.0	2.520	2.524	2.528	2.532	2.537	2.541	2.545	2.549	2.553	2.558
4.1	2.562	2.566	2.570	2.474	2.579	2.583	2.587	2.591	2.595	2.599
4.2	2.603	2.607	2.611	2.616	2.620	2.624	2.628	2.632	2.636	2.640
4.3	2.644	2.648	2.653	2.657	2.661	2.665	2.669	2.673	2.677	2.681
4.4	2.685	2.689	2.693	2.698	2.702	2.706	2.710	2.714	2.718	2.722
4.5	2.726	2.730	2.734	2.738	2.742	2.746	2.750	2.754	2.758	2.762
4.6	2.766	2.770	2.774	2.778	2.782	2.786	2.790	2.794	2.798	2.802
4.7	2.806	2.810	2.814	2.818	2.822	2.826	2.830	2.834	2.838	2.842
4.8	2.846	2.850	2.854	2.858	2.862	2.865	2.869	2.873	2.877	2.881
4.9	2.885	2.889	2.893	2.897	2.901	2.904	2.908	2.912	2.916	2.920

**Table 9-3: Values of S<sup>1/2</sup>**

Number	0.---0	0.---1	0.---2	0.---3	0.---4	0.---5	0.---6	0.---7	0.---8	0.---9
0.00001	.003162	.003317	.003464	.003606	.003742	.003873	.004123	.004123	.004243	.004359
0.00002	.004472	.004583	.004690	.004796	.004899	.005000	.005099	.005196	.005292	.005385
0.00003	.005477	.005568	.005657	.005745	.005831	.005916	.006000	.006083	.006164	.006245
0.00004	.006325	.006403	.006481	.006557	.006633	.006708	.006782	.006856	.006928	.007000
0.00005	.007071	.007141	.007211	.007280	.007348	.007416	.007483	.007550	.007616	.007681
0.00006	.007746	.007810	.007874	.007937	.008000	.008062	.008124	.008185	.008246	.008307
0.00007	.008367	.008426	.008485	.008544	.008602	.008660	.008718	.008775	.008832	.008888
0.00008	.008944	.009000	.009055	.009110	.009165	.009220	.009274	.009327	.009381	.009434
0.00009	.009487	.009539	.009592	.009644	.009695	.009747	.009798	.009849	.009899	.009950
0.0001	.01000	.01049	.01095	.01140	.01183	.01225	.01265	.01304	.01342	.01378
0.0002	.01414	.01449	.01483	.01517	.01549	.01581	.01612	.01643	.01673	.01703
0.0003	.01732	.01761	.01789	.01817	.01844	.01871	.01897	.1924	.01949	.01975
0.0004	.02000	.02025	.02049	.02074	.02098	.02121	.02145	.02168	.02191	.02214
0.0005	.02236	.02258	.02280	.02302	.02324	.02345	.02366	.02387	.02408	.02429
0.0006	.02449	.02470	.02490	.0210	.02530	.02550	.02569	.02588	.02608	.02627
0.0007	.02646	.02665	.02683	.02702	.02720	.02739	.02757	.02775	.02793	.02811
0.0008	.02828	.02846	.02864	.02881	.02898	.02915	.02933	.02950	.02966	.02983
0.0009	.03000	.03017	.03033	.03050	.02066	.02082	.02098	.02114	.02130	.03146
0.0010	.03162	.02178	.03194	.03209	.03225	.03240	.03256	.03271	.03286	.03302
0.001	.03162	.03317	.03464	.03606	.03742	.03873	.04000	.04123	.04243	.04359
0.002	.04472	.04583	.04690	.04796	.04899	.05000	.05099	.05196	.05292	.05385
0.003	.05477	.05568	.05657	.05745	.05831	.05916	.06000	.06083	.06164	.06245
0.004	.06325	.06403	.06481	.06557	.06633	.06708	.06782	.06856	.06928	.07000
0.005	.07071	.07141	.07211	.07280	.07348	.07416	.07483	.07550	.07616	.07681
0.006	.07746	.07810	.07874	.07937	.08000	.08062	.08124	.08185	.08246	.08307
0.007	.08367	.08426	.08485	.08544	.08602	.08660	.08718	.08775	.08832	.08888
0.008	.08944	.09000	.09055	.09110	.09165	.09220	.09274	.09327	.09381	.09434
0.009	.09487	.09539	.09592	.09644	.09695	.09747	.09798	.09849	.09899	.09950
0.010	.10000	.10050	.10100	.10149	.10198	.10247	.10296	.10344	.10392	.10440
0.01	.1000	.1049	.1095	.1140	.1183	.1225	.1265	.1304	.1342	.1378
0.02	.1414	.1449	.1483	.1517	.1549	.1581	.1612	.1643	.1673	.1703
0.03	.1732	.1761	.1789	.1817	.1844	.1871	.1897	.1924	.1949	.1975
0.04	.2000	.2025	.2049	.2074	.2098	.2121	.2145	.2168	.2191	.2214
0.05	.2236	.2258	.2280	.2302	.2324	.2345	.2366	.2387	.2408	.2429
0.06	.2449	.2470	.2490	.2510	.2530	.2550	.2569	.2588	.2608	.2627
0.07	.2646	.2665	.2683	.2702	.2720	.2739	.2757	.2775	.2793	.2811
0.08	.2828	.2846	.2864	.2881	.2898	.2915	.2933	.2950	.2966	.2983
0.09	.3000	.3017	.3033	.3050	.3066	.3082	.3098	.3114	.3130	.3146
0.10	.3162	.3178	.3194	.3209	.3225	.3240	.3256	.3271	.3286	.3302

**Table 9-4: Manning's n for Natural Stream Channels (surface width at flood stage less than 30 m)**

Natural stream channels	n
1. Fairly regular section:	
Some grass and weeds, little or no brush	0.030 - 0.035
Dense growth of weeds, depth of flow materially greater than weed height	0.035 - 0.050
Some weeds, light brush on banks	0.050 - 0.070
Some weeds, heavy brush on banks	0.060 - 0.080
Some weeds, dense willows on banks	0.010 - 0.020
For trees within channel, with branches submerged at high stage, increase above values by	0.010 - 0.020
2. Irregular sections, with pools, slight channel meander; increase values given above by	0.010 - 0.020
3. Mountain streams, no vegetation in channel, banks usually steep, trees and brush along banks submerged at high stage:	
Bottom of gravel, cobbles, and few boulders	0.040 - 0.050
Bottom of cobbles with large boulders	0.050 - 0.070

Source: (Highway Task Force, 1971)



## 10 GROUND WATER PROTECTION

### 10.1 DEFINITIONS

“Adverse impact” means a reduction in ground water level or a change in ground water quality that limits the ability of any existing ground water user lawfully withdrawing or authorized to withdraw ground water to continue to withdraw the quantity and quality of ground water required by the existing use.

“Aquifer” means a water-bearing layer of rock, including unconsolidated sediments that will yield water in a usable quantity to a well or spring.

“Confined water” means ground water that is separated from the atmosphere by impermeable geologic material called a confining bed; artesian.

“Consumptive use” means the withdrawal of ground water, without recycle of said waters to their source of origin.

“Hydraulic head” means the height above a datum plane of a column of water. In a ground water system it is composed of elevation head and pressure head; the water level elevation in a well, or elevation to which the water of a flowing artesian well will rise in a pipe.

“Ground water” means any water, except capillary moisture, that occurs beneath the land surface in the zone of saturation, including perched zones of saturation, which could produce usable water.

“Unconfined water” means ground water that is in direct contact vertically with the atmosphere through open spaces in permeable material.

“Water table” means the surface of a body of unconfined ground water (i.e. saturated zone) at which the hydraulic pressure is equal to atmospheric pressure and is represented by the water level in a well.

“Well” means any artificial opening or artificially altered natural opening, however made, by which ground water is sought or through which ground water flows under natural pressure or is intended to be withdrawn.

### 10.2 PURPOSE

Mineral mining activities that are conducted below the water table may cause alterations of ground water flow and distribution patterns that can affect other sources of ground water use. Mine excavations that expose a drinking water aquifer to activities at the land surface also open pathways for potential contamination and degradation of water quality. Regulation 4 VAC 25-31-130(6) of the *Reclamation Regulations for Mineral Mining* requires that mine operators provide a plan for the minimization of adverse effects on water quality or quantity if mining below the water table is to take place. This plan, hereafter referred to as the “ground water protection plan”, must be approved by DMM prior to the commencement of such mining activities. Regulation 4 VAC 25-31-130(6) applies to new permit applications as well as existing permit holders that plan to expand mining activities below the water table.

In general, the ground water protection plan should be supported by information gathered as part of a hydrologic baseline and impact assessment. This assessment should include (1) an evaluation of the baseline conditions of the local and/or regional hydrologic system, and (2) a determination of the probable impacts of the proposed operation on that system. The hydrologic baseline and impact assessment will provide the basis for a mining plan that is effectively designed to minimize adverse hydrologic effects.

In this section, the key steps towards developing a ground water protection plan are summarized, and basic methods for conducting the hydrologic baseline and impact assessment are described in a way that should be useful to individuals with no technical background in hydrology. Because the assessment of potential impacts is so dependent upon a thorough understanding of baseline conditions, as well as a wide range of possible mine operating parameters, the bulk of this section is focused upon baseline assessment methods. These practical methods are intended as guidance primarily for small mine operations that will not involve deep excavations or extensive de-watering below the ground water table. Larger operations, and those that involve more complex hydrogeologic settings may use this information for guidance, but are encouraged to utilize the services of professional hydrologists to develop an effective protection plan. Mine operators are encouraged to incorporate ground water monitoring to measure the success of compliance with the performance-based standard.

There are many alternatives to the methods described in this section, and the operator is encouraged to utilize other methods where appropriate. A list of useful references is included at the end of this chapter.

### **10.3 KEY STEPS TOWARDS DEVELOPING THE GROUND WATER PROTECTION PLAN**

1. Complete an evaluation of the baseline hydrologic conditions in the local area and/or region surrounding the mining operation. Depending upon the specific mining plan, the following items should be addressed:
  - inventory of existing ground water use;
  - depth to the static water table and maximum depth of mining;
  - hydraulic gradient and direction of ground water movement;
  - sources and rates of natural discharges;
  - natural recharge rate;
  - ground water velocity;
  - physical properties of aquifers;
  - geologic factors;
  - land use;
  - ambient ground water chemistry.
  
2. Complete an assessment of the potential impacts of the mining operation on ground water quality and water quantity. Depending upon the specific operating plan, the assessment may include:
  - effects of ground water withdrawal (mine de-watering) on water supply;
  - effects of removing portions of an aquifer on water supply;
  - plans for managing withdrawn ground water;

- expected changes in ground water quality as a result of mining and reclamation;
  - potential for accidental releases of pollutants.
3. Based upon the results of the hydrologic baseline and impact assessment (Steps 1 and 2), design a ground water protection plan that will minimize any likely adverse impacts on ground water quality or quantity as a result of mining or reclamation operations.

## 10.4 EVALUATION OF BASELINE HYDROLOGIC CONDITIONS

Baseline information describes site-specific conditions prior to mining and provides a starting point from which to make predictive estimates of the probable hydrologic impacts, if any, of the proposed operation. Where applicable, baseline information should be collected and analyzed well in advance of the proposed mining operation, and in such a manner as to provide a statistically valid representation of the site water supply.

Factors that should be considered in the baseline assessment include those described in more detail below. Some of the suggested methods for measuring hydrologic properties are highly simplified using “rules of thumb” to facilitate data collection and analysis for small operations where the potential for ground water impacts are expected to be minimal. For larger or more complex operations, the process of data collection and analysis for many of these factors may require well drilling, aquifer pump testing, laboratory analysis, and model simulations.

### Inventory of Existing Ground Water Use

The baseline assessment should include an inventory of all sources of ground water use within a minimum of 1000 feet of the mining permit boundary. The inventory should encompass ground water sources for residential, commercial, industrial, municipal and recreational use.

Section 10.7 includes a sample form entitled *Water Supply Inventory List* that is recommended for use in recording the inventory. The form includes space for recording information that is useful in classifying the ground water source and assessing baseline conditions. Key information includes the owner, type of use, geographic coordinates, wellhead elevation, static ground water elevation, and the date of the measurement. Other categories of information shown on the form include the total well depth, year drilled, well diameter, casing length, screen length and size, type and intervals of seals and grout, reported well yields, flow rates, etc. If the ground water source is used for a drinking water supply, much of this latter information will be contained in the well driller's report and well construction report that is available from the Virginia Department of Health, Office of Environmental Health Services.

### Static Water Table and Maximum Depth of Mining

An estimate of the position of the static water table relative to the maximum depth of the proposed mine is required as part of the mine permit application. The static water table represents the pre-mining level of ground water in the area of the proposed excavation. It is typically measured in units of elevation above mean sea level (amsl) based upon some specified map reference datum. Unless the water table is above the land surface, as may be the case in natural discharge areas like streams and wetlands (Figure 10-1), it may also

**Figure 10-1: Maximum mine depth compared to seasonal variations in the pre-mining static water table of an unconfined ground water system.**

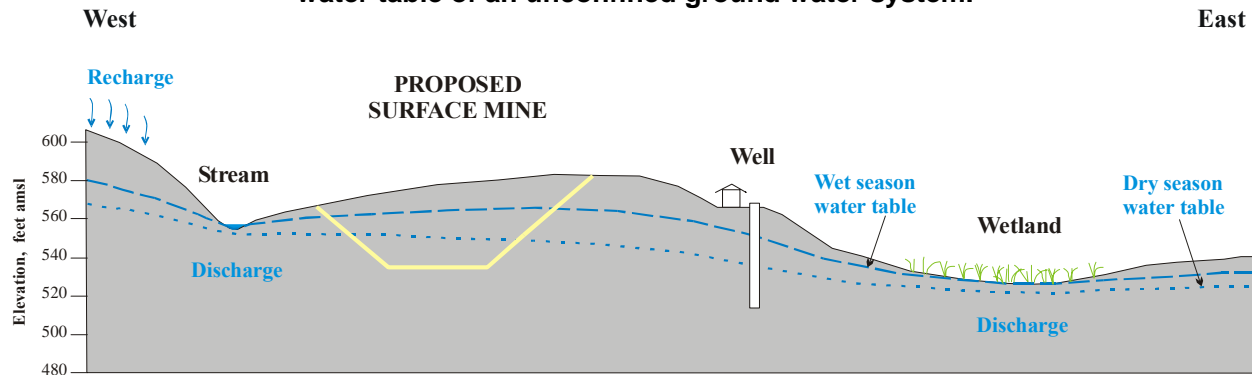

be measured in units of depth below some reference point at the land surface. Depending upon the specific hydrologic setting, the position of the water table may vary both seasonally and as a result of consumptive use. If mining will be conducted year-round, these variations should be considered.

Useful methods for portraying the static water table in two dimensions are depth to water table contour maps, ground water elevation contour maps, and hydrogeologic cross sections (Figure 10-2a-c).

Each of these depictions requires input of static ground water level data from individual measuring points, usually attained from water wells and springs. Typically, there will not be enough ground water measurement points in the proposed mining area to create meaningful contour maps as shown in Figures 10-2a and 10-2b.

Hydrogeologic cross sections on the other hand are an effective method of showing the water table when water levels from two or more measuring points are known. If the measuring points are water wells constructed in the same aquifer, or are otherwise hydrologically connected, the water table may be depicted as a line projected between the ground water measuring points (Figure 10-2c).

All relevant geologic and hydrologic data should also be shown on the diagram such as aquifer thickness, confining beds if any, geologic structure, and well construction details. The direction of the line of section should also be indicated on a plan view map. By superimposing the anticipated maximum depth of mining on the cross section, the proposed excavation may be readily compared to a number of important hydrologic characteristics.

### Measuring Static Ground Water Levels

Measurements of static ground water levels at individual measuring points provide essential information for constructing contour maps and hydrogeologic cross sections. There are numerous methods for measuring ground water levels, usually attained from natural seeps and springs, and wells.

**Figure 10-2a: Method of representing water level data on plan view maps: contoured depth to ground water, in feet below ground surface (bgs).**

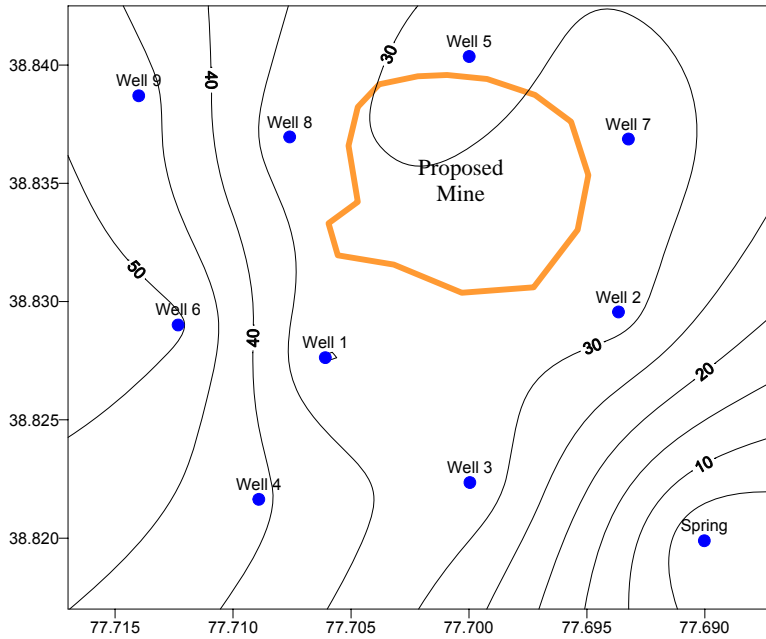

**Figure 10-2b: Method of representing water level data on plan view maps: contoured ground water elevation, in feet above mean sea level. Line of cross section is used in Figure 10-2c**

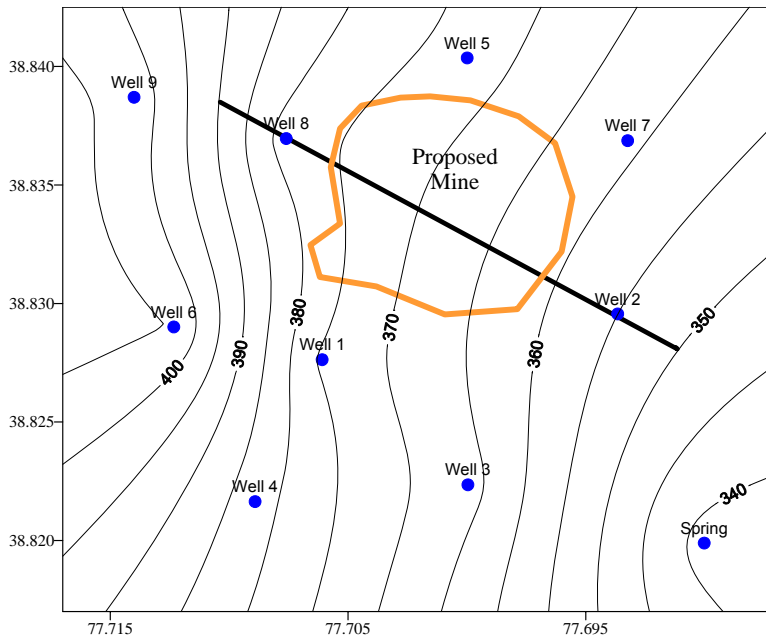
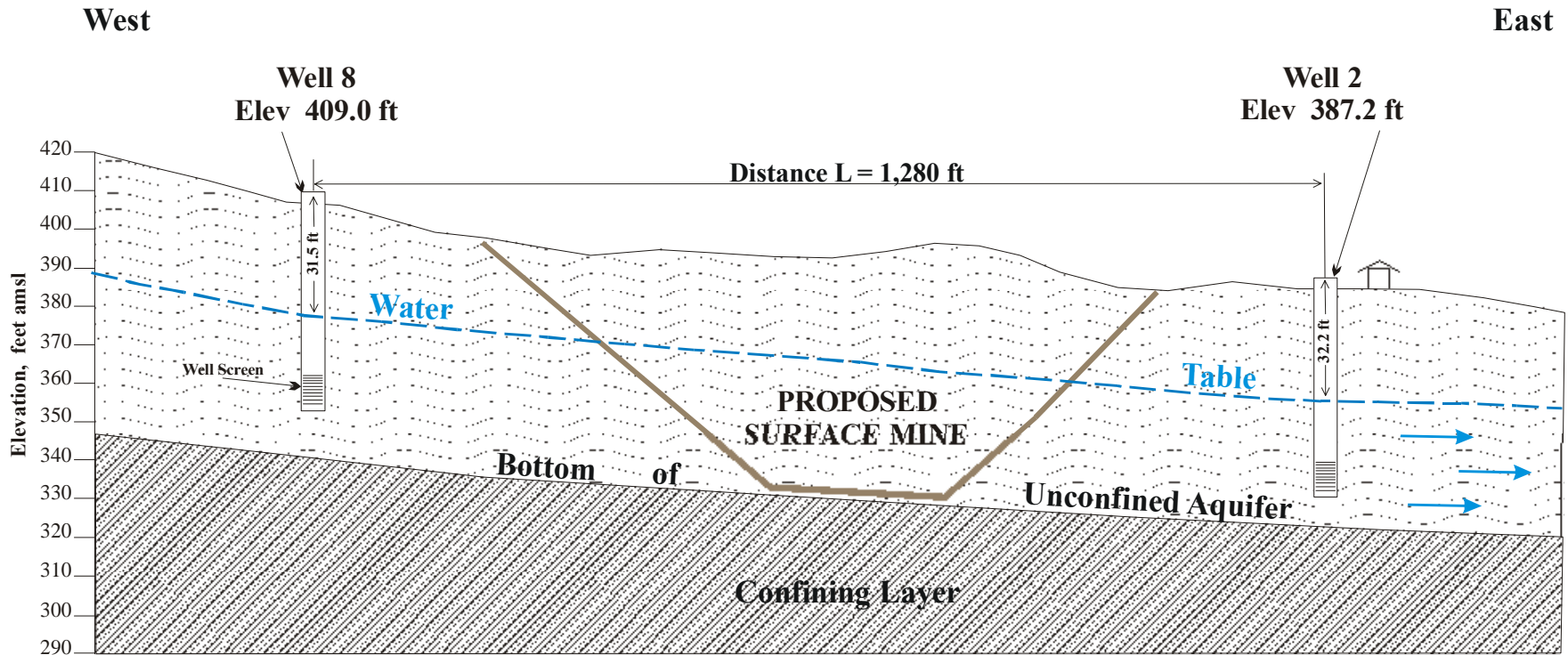

Figure 10-2c: Method of representing ground water level data using a hydrogeologic cross-section. Location in plan view of the line of cross section is shown in Figure 10-2b.



(c)



Natural seeps, springs, marshes, ponds, and lakes often indicate where the ground water table of an unconfined aquifer intersects the land surface (Figures 10-1, 10-3). These features may also represent discharge from a flowing artesian or confined aquifer. Static ground water levels may thus be attained by recording the geographic coordinates and elevations of these features referenced to a specified map datum. To the degree that spring discharges are related to the relative elevation of the static water table, which often varies on a seasonal basis, it is also important to note the time and date of measurement along with the estimated flow rate.

**Figure 10-3: Surface indications of ground water: location of springs dependent upon rock permeability. Source: Davis and DeWiest (1966).**

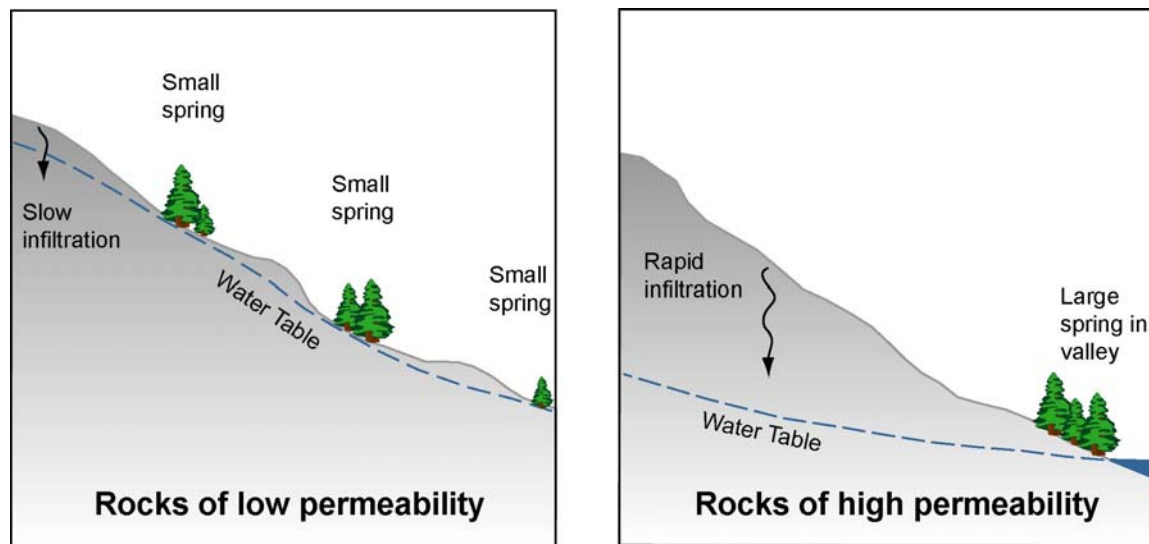

Static water levels are also attained from wells that have not been recently pumped. These can include water supply wells such as those listed in the inventory of ground water use and monitoring wells that have been constructed for this specific purpose.

When assessing the position of the static water table, it is important to distinguish between water levels representing unconfined ground water systems that may include perched zones and those representing confined ground water. The water level in a tightly cased well open to a confined aquifer stands at the level properly known as the potentiometric or piezometric surface. The water table of an unconfined aquifer and the potentiometric surface of a confined aquifer may stand at significantly different levels (Figure 10-4).

Several of the most common techniques for measuring ground water levels in wells open to either unconfined or confined aquifers are described below. These methods are appropriate not only for gathering information for the initial hydrologic assessment, but also for ongoing ground water monitoring activities that are incorporated into the ground water protection plan. For all of these methods it is important to exercise extreme care when making measurements in a well in which a pump is installed.

**Figure 10-4: Comparison of the regional water table of an unconfined aquifer, piezometric surface of a confined aquifer, and perched water table. Source: modified from USBR Ground Water Manual (1977).**

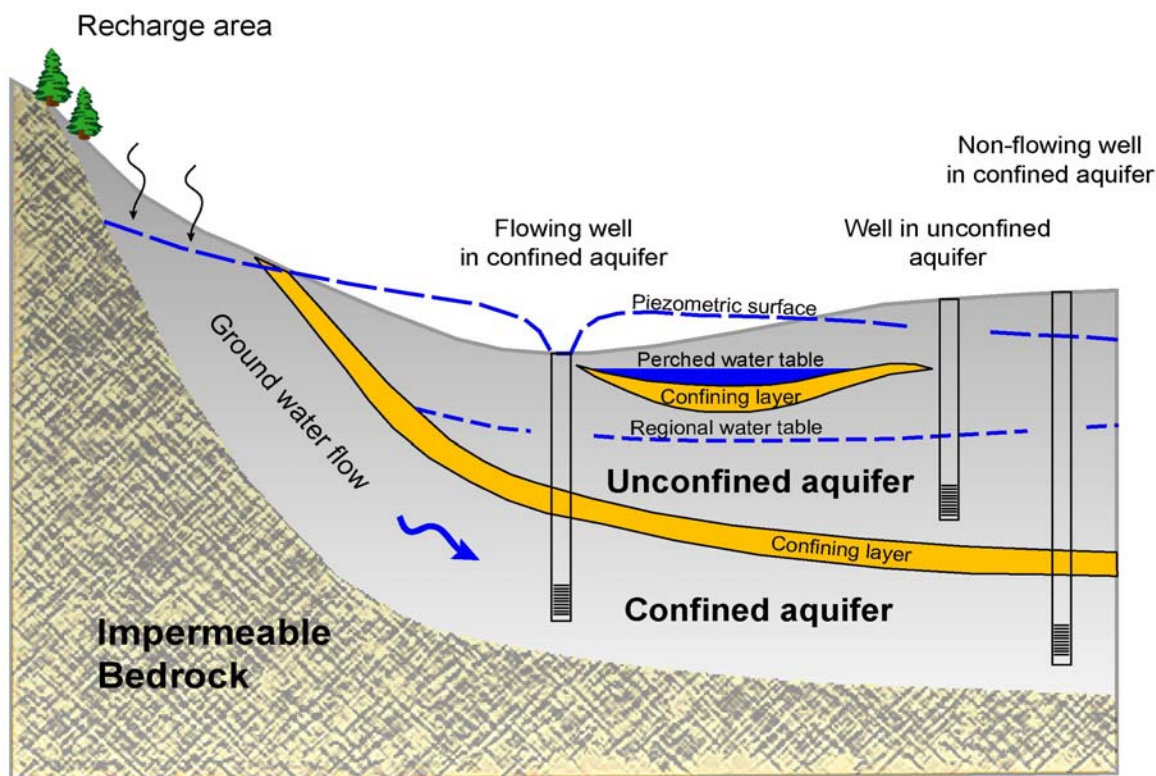

### **Electric Sounder or Electric Depth Gauge Method**

One of the simplest methods to measure the depth to the water table in a well is by using an electric sounder. An electric sounder consists of an electrode suspended at the end of a pair of insulated wires that run the length of a graduated tape or cable (Figure 10-5). An ammeter indicates a closed circuit and flow of current when the electrode touches the water surface in a well. A small 9-volt battery supplies the current. Electric sounders with tapes of varying lengths and a reel for winding the tape are available commercially.

To make a reading, the electrode is lowered down the well casing until the instrument indicates that water has been encountered. The depth of the tip of the electrode below the water level measuring point is read from the graduated tape. If the elevation of the water level measuring point is known, then the elevation of the water table may be derived by subtracting the measured depth.

### **Chalk and Graduated Steel Tape Method**

A common technique for measuring the static water level in a well is the chalked steel tape method. This method requires that the water level be roughly known in advance to within several feet. The graduated steel tape (or surveyor's chain) has a small weight attached to the lower end to keep the tape taut when being lowered down the well (Figure 10-5).



**Figure 10-5: Methods for measuring the ground water level in a well.**  
Source: Trimmer (2000).

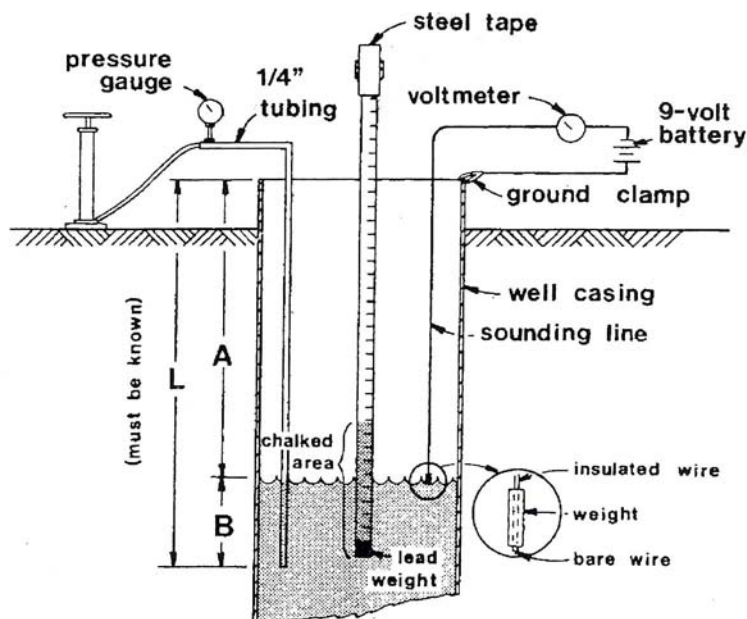

Carpenter's chalk is applied to the lower five feet of the tape, which turns to a different color or shade upon becoming wet when immersed below the water table. The graduated tape is lowered to the predetermined approximate depth and then adjusted to the next convenient depth marker held at the measuring point. The tape is then pulled up and the wetted length is subtracted from the reading of the tape at the measurement point to attain the depth to water to the nearest hundredth of a foot. If the elevation of the water level measuring point is known, then the elevation of the water table can be derived by subtracting the measured depth.

### ***Air Line and Pressure Gauge Method***

This method uses a small diameter (0.25") pipe or tube (air line) installed vertically in the well to a depth several feet below the lowest anticipated water level. Copper, brass, steel or plastic is commonly used. The length of the air line should be measured precisely and it must be air tight. The upper end of the air line is fitted with a Schraeder valve so that an ordinary tire pump can be used to pump air into the line (Figure 10-5). An air pressure gauge is placed on the air line at a tee below the valve. An advantage of this method is that once installed, repeated measurements may be made relatively quickly.

To measure the water level, pump air into the air line until the pressure shown on the gauge levels off at a constant maximum, indicating that all water has been pumped out of the air line. This air pressure, which effectively supports the column of water from the water level in the well to the bottom of the air line, is equivalent to the length of air line submerged. Subtract this air pressure converted to feet (pounds pressure x 2.31 = feet) from the known total length of the air line to attain the depth to water below the measuring point. If the elevation of the water level measuring point is known, subtract the measured depth to derive the elevation of the water table.

## Hydraulic Gradient

The hydraulic gradient is the slope of the water table in a specified direction, usually given as the direction of maximum change in water level elevation. Insofar as gravity is the dominant driving force under natural conditions for ground water movement, the commonly accepted rule of thumb is that the direction of flow will follow surface topography. There are a number of exceptions to this rule (note for example Figure 10-3a), and it may be difficult to apply in many flatter regions of the state. Nevertheless, the importance of this parameter in the hydrologic assessment cannot be overstated since the potential for adverse impacts of a mine operation on other sources of ground water use is most likely in down-gradient regions. If monitoring is to be incorporated in the ground water protection plan, knowledge of the hydraulic gradient will be necessary for locating up-gradient and down-gradient monitoring sites. Listed below are two commonly used methods for calculating hydraulic gradient.

### Cross Section Method

The hydraulic gradient can be taken directly from a hydrogeologic cross section if the line of section is constructed in a parallel direction to the maximum rate of decrease in head indicated by at least two ground water measuring points (e.g. wells in Figure 10-2c). This method relies on advance knowledge of the general direction of ground water movement.

In the example given in Figure 10-2c, the hydraulic gradient is calculated using the formula below, where  $\Delta H/L$  is the hydraulic gradient,  $h_2$  and  $h_1$  are the water level elevations measured at individual measuring points (Well 8 and Well 2, respectively), and  $L$  is the distance between:

$$\Delta H/L = (h_2 - h_1) / L$$

$$\begin{aligned} \Delta H/L &= ((409.0 - 31.5) - (387.2 - 32.2)) / 1,280 \text{ ft} \\ &= 22.5 \text{ ft per } 1,280 \text{ ft} \end{aligned}$$

$$\Delta H/L = \underline{0.018 \text{ ft ft}^{-1}} \text{ (also may be expressed as } 92.8 \text{ feet per mile)}$$

### Three-Point Method

The hydraulic gradient and the direction of ground water movement can be calculated using the three-point method when the water level elevations and distances between each of three wells are known and the wells are located in any triangular arrangement as shown in Figure 10-6.

The steps in the three-point method are as follows:

1. plot the location of the three wells in plan view relative to map north, and scale off the distance between each well;
2. draw a straight line between the well having the highest water level elevation and the well having the lowest water level elevation; calculate the position along this line that is equal to the water level elevation of the intermediate well;

**Figure 10-6: Three-point Method for Calculating Hydraulic Gradient.**  
Source: modified from Heath (1998).

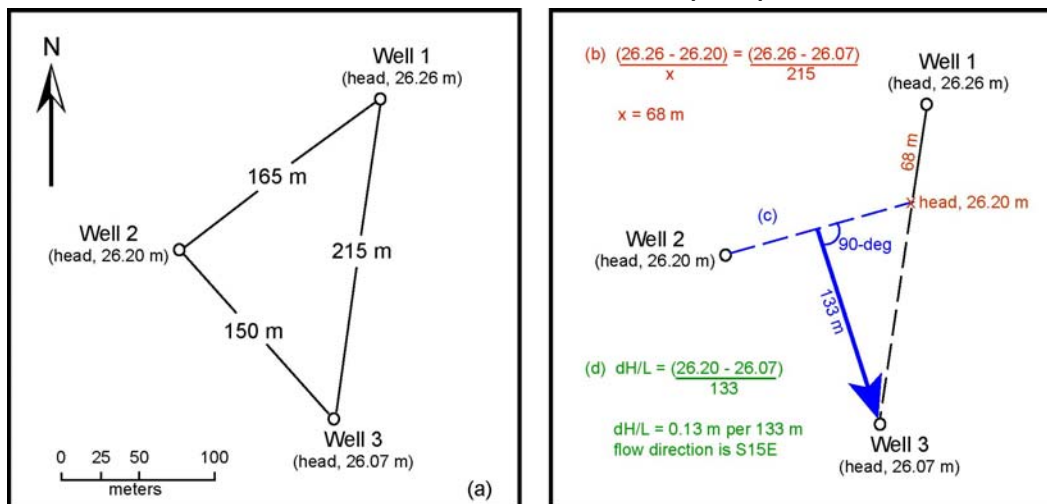

3. draw a straight line between this point and the intermediate well, which will represent a segment of equivalent head (i.e. water level contour); draw a line perpendicular to the water level contour through either of the other two wells, which represents the direction parallel to that of ground water movement (relative to map north);
4. the difference between the water level contour elevation and the water level elevation of the well divided by the scaled distance between the contour line and the well is the hydraulic gradient ( $\Delta H/L = 0.13 \text{ m per } 133 \text{ m}$ , direction is south 15 degrees east).

### Estimating Natural Ground Water Discharge

Natural discharges of ground water occur as seepage to springs and gaining streams, as evaporation and transpiration, and as subsurface outflow. Discharge is usually expressed in units of volume of water per unit time (e.g. cubic feet per day, acre-feet per year, etc.).

Practical methods for measuring discharge from springs and as stream base flow are given below and should be considered, where site conditions warrant, as part of the baseline hydrologic assessment for small mine operations. This data might be important if, for example, the proposed mining operation has the potential to alter the flow rate of a spring used for drinking water. Measurements of evaporation and transpiration rates are complex and a discussion of methods is beyond the scope of this guidance document. Similarly, the measurement of subsurface outflow requires knowledge of specific aquifer properties usually obtained by laboratory analysis and aquifer pump tests. Nevertheless, a method for estimating subsurface outflow using standard “rule-of-thumb” values for these properties is provided below.

### Measuring Natural Discharge of Springs

Springs and seeps often indicate where an unconfined aquifer intersects the land surface. Measuring the flow rate of springs is relatively simple when the discharge is localized in a well-defined channel. Seeps are typically more diffuse and may be difficult to quantify. For well-defined springs, the water is channeled to a point where it can be measured using a

control section such as a weir or flume, or more simply by volume received in a container per unit time (e.g. gallons per minute, cubic feet per second). As indicated earlier, it is important to note the geographic coordinates and date of measurement. Spring flow rates will often vary seasonally, so it is important to collect data representative of all seasonal variability if possible.

### **Measuring Natural Discharge as Base Flow of a Stream**

By definition, a gaining stream is surface water flow in a perennial or intermittent stream channel that is sustained by ground water discharge, also termed base flow. The amount of ground water discharged to a stream usually varies along any given section of stream reach and may also vary seasonally. Dry weather conditions are the best time to measure base flow, when spring and/or summer surface runoff are at a minimum. In the example shown in Figure 10-7, base flow is measured between two gauging stations along a stream reach (x).

Average daily flow at Station A:	$20.5 \text{ ft}^3 \text{ s}^{-1}$
Average daily flow at Station B:	$19.8 \text{ ft}^3 \text{ s}^{-1}$
Increase in flow from Station B to Station A due to base flow:	$0.7 \text{ ft}^3 \text{ s}^{-1}$
Total daily base flow:	$60,480 \text{ ft}^3 \text{ d}^{-1}$
Total daily discharge from one-half of the aquifer (same side of the stream as mining operation):	<u><math>30,240 \text{ ft}^3 \text{ d}^{-1}</math></u>

This example assumes the availability of discharge records at selected gauging stations along a stream that is situated near the proposed mining operation. Stream gauging station records also provide the means for assessing base flow using methods that analyze the discharge hydrograph. Methods for hydrograph analysis and base flow separation are found in most hydrology reference texts and are not reproduced here. Setting up of stream gauging stations and stream flow measurements in general are somewhat involved and beyond the scope of this guidance document. There are a number of existing gauging stations located throughout the state that are monitored by the Department of Environmental Quality (DEQ), and long-term discharge records are published each year by the U.S. Geological Survey.

### **Estimating Discharge as Subsurface Outflow**

An estimation of subsurface outflow of ground water beneath the proposed mine site can provide a baseline condition in the hydrologic assessment that may be used to evaluate the potential impacts of water withdrawals associated with mining. This estimate may be accomplished if certain aquifer properties are known. These properties include the ground water flow system dimensions, the hydraulic gradient, and transmissivity. Ground water system boundaries may be apparent in many situations, and might include streams, mountain peaks, ridgelines, geologic features, etc. For the purposes of the hydrologic assessment, it may be possible to assume boundaries that are coincident with the permit area. Transmissivity (see further explanation for this term below) is the capacity of the aquifer to transmit water over the full aquifer thickness, and is represented by the equation,

**Figure 10-7: Measuring natural discharge as base flow in a stream.**  
Source: modified from Heath (1998).

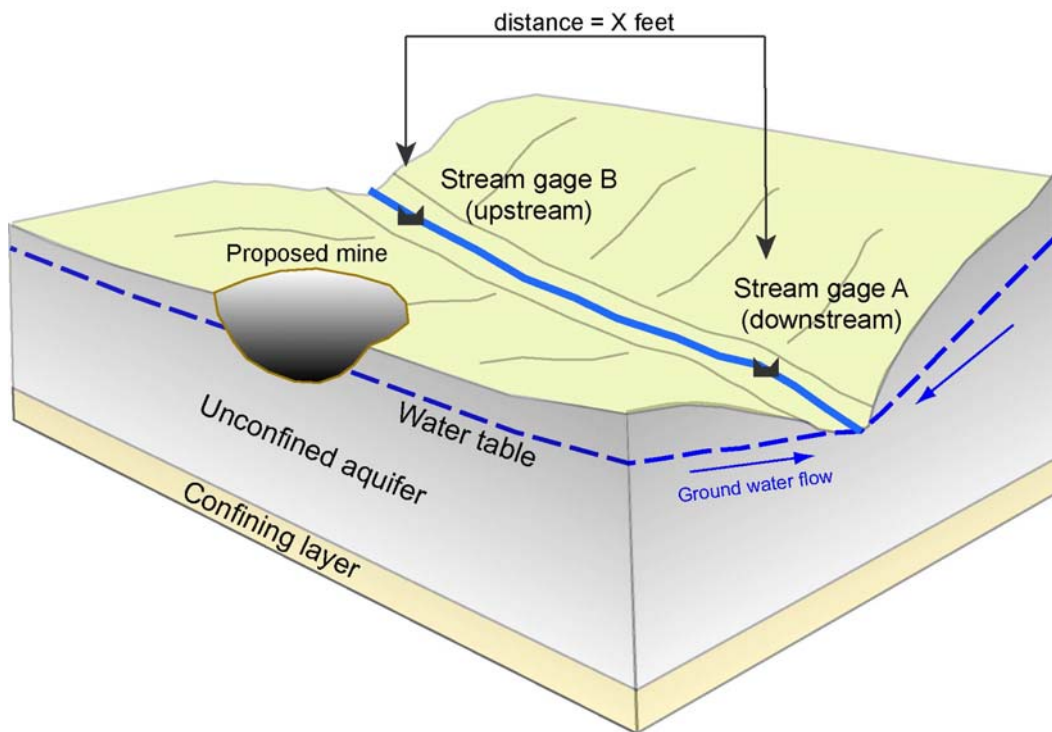

$$T = K \cdot b$$

where: T is transmissivity, K is the hydraulic conductivity, and b is the average saturated thickness of the aquifer. In the absence of site-specific data, the value of K may be estimated based upon general characteristics of the aquifer material (Table 10-1). The value of b may be estimated based on information that is often available from well driller logs. After calculating the value for T using the equation above, the resultant value is used in the following equation:

$$Q = TW \cdot (\Delta H/L)$$

where Q is the quantity of water moving through a large width (W) of an aquifer with transmissivity T, and  $\Delta H/L$  is the hydraulic gradient.

In Figure 10-8, the amount of water flowing out of the right side of the diagram (chosen to coincide with a hypothetical permit boundary) is calculated for a mine site situated over an aquifer composed of fine sand. The value of W was selected as the length of the permit boundary line on the down-gradient side of the permit area, and perpendicular to the direction of ground water movement.

**Table 10-1: Representative Values for Hydraulic Properties of Natural Geologic Materials**

Material	Porosity <sup>1</sup> (n) % by volume	Specific Yield <sup>2</sup> (S <sub>v</sub> ) % by volume	Hydraulic Conductivity <sup>1</sup> (K) meters/sec	
			High	Low
<b>Unconsolidated</b>				
Soil (Loam)	55	40	10 <sup>-5</sup>	
Clay	34 – 60	3	4.7x10 <sup>-9</sup>	10 <sup>-11</sup>
Silt	34 – 61	8	2x10 <sup>-5</sup>	10 <sup>-9</sup>
Fine Sand	26 – 53	23	2x10 <sup>-4</sup>	2x10 <sup>-7</sup>
Coarse Sand	31 – 46	27	3x10 <sup>-3</sup>	9x10 <sup>-7</sup>
Gravel	24 – 38	24	3x10 <sup>-2</sup>	3x10 <sup>-4</sup>
<b>Sedimentary Rocks</b>				
Limestone, dolomite	0 – 20	14	6x10 <sup>-6</sup>	10 <sup>-9</sup>
Karst limestone	5 – 50		2x10 <sup>-2</sup>	10 <sup>-6</sup>
Sandstone	5 – 30	27	6x10 <sup>-6</sup>	3x10 <sup>-10</sup>
Siltstone	21 – 41	12	1.4x10 <sup>-8</sup>	10 <sup>-11</sup>
Shale	0 – 10		2x10 <sup>-9</sup>	10 <sup>-13</sup>
<b>Crystalline Rocks</b>				
Permeable basalt			2x10 <sup>-2</sup>	4x10 <sup>-7</sup>
Basalt	3 – 35	8	4.2x10 <sup>-7</sup>	2x10 <sup>-11</sup>
Weathered granite	34 – 57	0.09	5.2x10 <sup>-5</sup>	3.3x10 <sup>-6</sup>
Fractured igneous and metamorphic rocks	0 – 10		3x10 <sup>-4</sup>	8x10 <sup>-9</sup>
Unfractured igneous and metamorphic rocks	0 – 5		2x10 <sup>-10</sup>	3x10 <sup>-14</sup>

<sup>1</sup> Data from Domenico and Schwartz, 1990; Davis, 1969; Heath, 1998.

<sup>2</sup> Data from Heath, 1998; Johnson, 1967.

To convert meters/second (m/sec) to:

cm/sec  
m/day  
cm<sup>2</sup>  
ft/sec  
ft/day  
ft<sup>2</sup>

Multiply by:

10<sup>2</sup>  
86,400  
10<sup>-3</sup>  
3.2808  
2.84 x 10<sup>5</sup>  
1.1 x 10<sup>-6</sup>

**Figure 10-8: Estimating ground water discharge as subsurface outflow**

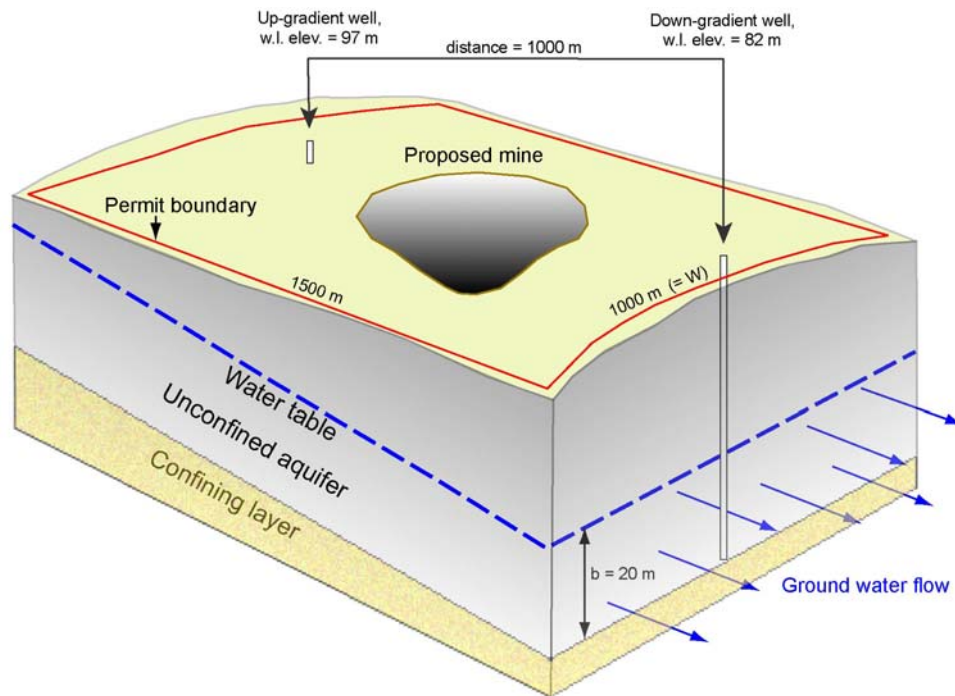

$$K = 17.3 \text{ m day}^{-1} \text{ (from Table 10-1, the high value of K for fine sand)}$$

$$b = 20 \text{ m (estimated from drill logs)}$$

$$T = Kb = (17.3 \text{ m day}^{-1}) * (20 \text{ m}) = \underline{346 \text{ m}^2 \text{ d}^{-1}}$$

$$W = 1000 \text{ m (estimated from map)}$$

$$\Delta H/L = (97\text{m} - 82\text{m}) / 1000\text{m} = \underline{0.015 \text{ m m}^{-1}}$$

(see "hydraulic gradient" above)

$$Q = TW * (\Delta H/L) = (346 \text{ m}^2 \text{ d}^{-1}) * (1000 \text{ m}) * (0.015 \text{ m m}^{-1})$$

$$= \underline{5190 \text{ m}^3 \text{ d}^{-1}}$$

### Estimating Natural Recharge

Natural recharge occurs as direct precipitation in the watershed, as seepage from losing streams, and as subsurface inflow. Recharge is typically expressed in units of volume of water per unit time (e.g. cubic feet per day, acre-feet per year, etc.).

Natural recharge is difficult to measure reliably due to the technical aspects of the measurements as well as the complexities of accounting for water that may be stored in the unsaturated zone above the water table. In most situations, direct precipitation of meteoric water accounts for the bulk of recharge to an aquifer, yet precipitation rates can vary widely across the watershed. For most small mine operations, estimates of ground water recharge are not critical for the evaluation of potential impacts to water quality or quantity. However,



monitoring precipitation at the proposed site can provide the basis for comparing this major source of recharge for different seasons and from year to year.

### **Measuring Precipitation**

Site-specific precipitation information is highly useful in monitoring environmental conditions, and it is recommended that measurements be collected at the mine site during the life of the operation. Interpretation of the rate of ground water recharge from this data, however, requires knowledge of several other key environmental conditions. These include seasonally variable evaporation and transpiration rates, soil moisture holding capacities, and existing soil moisture conditions leading up to precipitation events. Each of these properties requires specialized measurements that for small operations are generally impractical. For larger operations, however, or those that need more substantial support for the ground water protection plan, an estimate of this component of total recharge may be appropriate.

The measurement of direct precipitation on the watershed can be accomplished effectively using a wide variety of commercially available rain gages. Some of these devices include capabilities for measuring rain and snow, event recorders, data loggers, etc. Depending upon the site location, it may also be possible to utilize long-term data records from nearby sites monitored by the National Weather Service (NWS). On-line climate data is available for many sites monitored by the NWS at their web site <http://www.srh.noaa.gov/>. Other sources of long-term climate records include the Virginia State Climatology Office (<http://climate.virginia.edu>) and the National Climatic Data Center (<http://lwf.ncdc.noaa.gov/oa/ncdc.html>).

### **Measuring Recharge as Stream Flow Seepage**

The methods described above for measuring discharge of ground water as base flow in a stream are also generally applicable to the measurement of ground water recharge by stream flow losses. In this case, the measured reduction of flow between two gaging stations is equated to water that percolates into the subsurface. To the extent that the measured loss of flow between two gaging stations on a stream may also be a result of evaporation, transpiration, and increased soil moisture storage, it is important to collect flow measurements at a time when evapotranspiration losses are at a minimum and soil moisture storage is relatively stable and near maximum capacity (i.e. field capacity). Once again, measurements of this type require sophisticated instrumentation that is generally impractical for small mine operations.

### **Ground Water Velocity**

The rate of ground water movement is an important parameter in the hydrologic assessment, particularly if there exists the possibility of a water quality impact as a result of mining or reclamation. A simple calculation for the ground water velocity may provide the means to roughly estimate the time it would take for a pollutant to reach a down-gradient ground water user. The equation:

$$v = K(\Delta H/L) / n$$



where  $v$  is the ground water velocity (more properly described as the Darcian velocity),  $K$  is the hydraulic conductivity,  $\Delta H/L$  is the hydraulic gradient, and  $n$  is the porosity, is derived from a combination of Darcy's law and the general velocity equation of hydraulics. A discussion of this derivation is beyond the scope of the present document, but additional information may be found in the references at the end of this chapter.

As shown above, the velocity equation requires estimates for the values of  $K$ ,  $\Delta H/L$ , and  $n$ . A method for calculating  $\Delta H/L$  was presented earlier under the Cross Section Method. Determining values for  $K$  and  $n$  can be considerably more, but for a rough estimation of ground water velocity, values may be selected from Table 10-1 based upon knowledge of the general properties of the aquifer material. In the example shown below, the ground water velocity for an aquifer composed of fine sand is calculated:

$$\begin{aligned} K &= 17.3 \text{ m day}^{-1} \text{ (from Table 10-1, for fine sand)} \\ n &= 0.26 \text{ (from Table 10-1, for fine sand)} \\ \Delta H/L &= 0.015 \text{ m m}^{-1} \text{ (from example given in Figure 10-8)} \\ \\ v &= K(\Delta H/L) / n = 17.3 \text{ m day}^{-1} * 0.015 \text{ m m}^{-1} / 0.26 \\ &= \underline{1.00 \text{ m d}^{-1}} \end{aligned}$$

Ground water velocities calculated using the equation above should be considered average values at best. The fastest rates of ground water movement may be many times larger, which should be considered when assessing the travel time of pollutants.

### **Aquifer Properties**

Many of the preceding methods for characterizing baseline conditions of the hydrologic system required estimated values for physical properties of the aquifer including porosity, hydraulic conductivity, and transmissivity. Methods to fully evaluate these and other important properties for specific site conditions often involve well drilling, aquifer pump testing, and laboratory analysis. Values obtained in this way are typically used in complex hydrologic investigations that involve analytical solutions or numerical modeling techniques. For the majority of small mine operations, this level of characterization is impractical, yet it may be useful to understand the type of information that would be provided by their measurement. In the absence of site-specific data, the typical range of values for several of these properties is shown in Table 10-1.

### **Porosity and Specific Yield**

Total Porosity ( $n$ ) of a geologic material is the percentage of the bulk volume that is occupied by interstices, or voids. In unconsolidated sediments such as sand, gravel, and clay the total porosity is determined not so much by grain size, but rather the range of variation in grain size, also referred to as the degree of sorting. Since fine-grained deposits tend to be better sorted, they tend to have larger porosities. In consolidated rocks such as sandstone, limestone, and granite the voids are typically secondary fractures and dissolution openings. The total porosity of these rocks is typically much smaller than that of unconsolidated deposits. Table 10-1 shows values of porosity that are typical for various geologic materials. Porosity is a dimensionless quantity that can be reported either as a decimal fraction or as a percentage.

In hydrology, total porosity is an indicator of the maximum amount of water that the material can contain when fully saturated. However, depending upon the type of material, not all of the water may be available to supply a well or spring. That amount of water that will drain under the influence of gravity is referred to as the specific yield ( $S_y$ ) of the material. Specific yield may be determined in the laboratory using drilled cores of aquifer material or by aquifer pump testing methods. In the absence of site-specific values for this parameter, average values shown in Table 10-1 may be used.

### **Hydraulic Conductivity**

Hydraulic conductivity (K), also known as the permeability coefficient, is a measure of the ability to transmit water through an aquifer. The term is derived from Darcy's law, expressed by the equation:

$$Q/A = q = -K(\Delta H/L)$$

which states that the quantity of water that flows per unit time (Q) through a unit cross-sectional area that is perpendicular to the flow direction (A), is proportional to the unit hydraulic gradient ( $\Delta H/L$ ) multiplied by a proportionality constant (K). The quantity q, the volumetric flow rate per unit surface area, is often termed the specific discharge. Since hydraulic conductivity is defined in terms of a unit gradient (a dimensionless quantity), the term is expressed in units of velocity (e.g. feet per day, centimeters per second). By convention, the equation uses a minus sign before the value of K to indicate downward water flow. Hydraulic conductivity is dependent upon the size and connectivity of water-transmitting voids in the aquifer material as well as on the dynamic properties of the fluid being transmitted (e.g. water viscosity, density). Table 10-1 shows the typical range of values for hydraulic conductivity for ground water transmitted through various geologic materials.

### **Transmissivity**

Transmissivity describes the rate at which water of the prevailing kinematic viscosity is transmitted through a unit thickness of the aquifer under a unit hydraulic gradient. It is equal to the hydraulic conductivity (K) multiplied by the saturated thickness (b) of the aquifer:

$$T = Kb$$

Transmissivity is typically determined by analysis of data obtained from aquifer tests. It is commonly expressed as volume per unit time per width of aquifer (e.g. gallons per day per foot, cubic feet per day per foot). Alternatively, since the value of T applies to a unit width of aquifer, it may be expressed as length squared per unit time (e.g. feet squared per day).

### **Ground water storage**

Ground water storage is the capacity for an aquifer to store water and is often described by the somewhat interchangeable terms specific yield, storativity, effective porosity, and coefficient of storage. The most commonly used term storativity (S) is defined as the

volume of water released from or taken into storage per unit surface area of the aquifer per unit change in the hydraulic head. It is expressed as the ratio

$$S = V' / V$$

where  $V'$  is the volume of water released and  $V$  is the volume of material drained. In an unconfined aquifer,  $S$  is determined by the size and interconnectedness of voids. The value of  $S$  typically ranges between 10 and 40 percent by volume. In contrast, the value of  $S$  in a confined aquifer is less dependent upon void space, and more upon the compactive pressure of the aquifer material and compressibility of water. The value of  $S$  in confined aquifers typically ranges between 0.00001 and 0.001 percent. The evaluation of storativity generally involves the analysis of aquifer tests.

### **Geologic Factors**

The baseline hydrologic assessment should incorporate discussion of the geologic setting of the proposed mine site, particularly in cases where geologic features may influence hydrologic conditions. For example, faults and fracture zones in bedrock can significantly influence ground water flow by providing a conduit through otherwise impermeable material. Conversely, faults may juxtapose an impermeable rock unit against a natural aquifer material, which may have the effect of limiting ground water flow across this structural boundary. Due to lower permeability, fine-grained geologic strata such as clay layers and shale formations may impede the downward flow of water resulting in unconfined "perched" ground water. Similarly, these low permeability materials may act as a barrier to upward flow (i.e. aquitard), resulting in a confined ground water system. Thus, the type of rock units present, their orientation, and juxtaposition may provide clues concerning the type of aquifers present (i.e. confined versus unconfined). Finally, the nature of the geologic materials that comprise the aquifer may provide information that would help interpret measurements of baseline ground water chemistry.

### **Land Use**

Information concerning historic or present-day land use that may have an influence on ground water resources in the proposed mine area should be included in the assessment of baseline conditions. In particular, the assessment should identify any potential hydrologic impacts from non-mining sources. These sources may include commercial or industrial activities, changes in vegetation type and density, agricultural practices, crop irrigation, changes in surface drainage patterns, etc.

### **Ground Water Chemistry**

If there exists the potential for introducing pollutants to ground water as a result of mining or reclamation, the hydrologic assessment should include laboratory and/or field measurements of the appropriate water quality parameters to establish baseline conditions of water quality. Just as the elevation of the water table may vary seasonally, so will the chemical characteristics of ground water. If possible, the seasonal variability should be evaluated. A major benefit of this evaluation will be in determining if there is a pre-existing condition of water quality impacts that are unrelated to mining.

It is highly recommended that a qualified hydrogeologist collect samples intended for laboratory analysis. Depending upon the parameters to be measured, water samples often

require specialized filtering and one of several acid preservation techniques that is most effectively completed in the field. Also, water samples from wells should be collected following a sufficient period of well system purging.

Field measurements of pH and electrical conductance (EC) are accomplished using any one of a wide variety of commercially available pH and EC meters. It is important that these devices be calibrated prior to field measurements following the manufacturer's recommendations.

## **10.5 ASSESSMENT OF POTENTIAL IMPACTS**

Predictive estimates of the impacts of the proposed mining operation on ground water quality and supply should be quantitative to the extent practicable. Supporting data may include analytical and statistical results as well as conceptual models where appropriate. For larger or more complex operations, hydrologic models ranging from simple empirical equations to numerical computer simulations may be used for estimating hydrologic impacts. Models should be calibrated with site-specific data or data that is otherwise representative of the site. Extrapolation of data from a nearby area to the proposed permit area is acceptable when the similarity of the areas is established and information is available to justify the correlations. Seasonal operating conditions should also be considered.

The assessment should include a prediction of impacts that will occur during the proposed mining and reclamation operations and also the potential for longer-term impacts, if any. Other factors that presently contribute to or may contribute to future changes in water quantity and quality, but are not related to the proposed mining operation, should be identified and quantified to the extent possible.

In the following sub-sections, several general categories of potential hydrologic impacts from mining are described. Depending upon the specific site conditions and mine operating plans, some or all of these potential impacts should be considered.

### **Effects of Ground Water Withdrawals on Water Supply**

Surface mining below the water table often necessitates simultaneous dewatering of the excavation. This is usually accomplished by pumping ground water, which may be commingled with accumulated storm water, from a sump located in the bottom-most level of the excavation. Figure 10-9 shows the potential effects of pumping ground water on the water table. In larger quarries, dewatering may be accomplished by pumping the ground water level down using wells strategically located at the periphery of the excavation. In either case, ground water is initially derived from storage in the aquifer immediately surrounding the sump or well, resulting in a cone of depression or local deviation of the hydraulic gradient (Figure 10-9b). As pumping continues the rate at which the cone of depression expands will depend mainly upon the aquifer properties of transmissivity and storativity. With extensive ground water withdrawals, changes in the hydraulic gradient may cause areas of natural discharge to become areas of recharge (Figure 10-9d). Within the range of influence of the cone of depression, well water levels will decline and other natural sources of discharge (e.g. springs and stream base flow) will show declines in flow rates. To the extent that mining may effectively remove large portions or critical flow paths (e.g.

fracture controls) of the natural aquifer, it is possible that some of these impacts will be irreversible.

For most small mineral mining operations, dewatering is unlikely to create a large cone of depression that will alter the regional pattern of ground water flow. For these operations, the assessment of potential impacts should consider the location of dewatering operations relative to other sources of ground water use, withdrawal rates, the duration of pumping, and methods to reclaim the excavated areas. Periodic monitoring of sensitive ground water discharge areas identified in the baseline assessment such as springs, stream base flow, and wetlands is highly recommended as part of the ground water protection plan.

The assessment of short-term and long-term impacts of ground water withdrawals associated with larger dewatering operations will require a more rigorous evaluation of the appropriate aquifer properties and other baseline parameters. The assessment should also include the location of dewatering operations relative to other sources of ground water use, withdrawal rates, the duration of pumping, estimates of the quantity of aquifer material that will be removed during mining, and methods to reclaim the excavated areas.

### **Effects of Removing Portions of an Aquifer on Water Supply**

Surface mine excavations below the ground water table will likely remove portions of the aquifer either as overburden, waste rock, or mine product. Depending upon the operating plan, this might occur with or without dewatering of the excavation. The assessment of potential impacts related to aquifer removal will depend largely upon plans for reclaiming the site. In cases where a substantial impact to water supply is predicted and unavoidable, the ground water protection plan should include appropriate mitigation measures.

### **Managing Pumped Ground Water**

There are a number of alternative methods for managing ground water after it has been pumped from a mine excavation including: (1) discharging the water into an existing stream channel; (2) storing the water in a lined impoundment for future use; (3) conveying the water to an unlined impoundment that serves as an infiltration gallery or ground water recharge facility; and (4) re-injecting the water into the subsurface through a well. The choice of management option will largely depend upon site conditions, the rate of ground water withdrawal, water quality factors, and other key mine operating parameters. Wise management of ground water after it has been withdrawn will effectively minimize the potential impacts on both water supply and water quality to down-gradient sources.

Regulatory authority over the disposal of ground water that is pumped from mine excavations to the land surface is vested in the Virginia Department of Environmental Quality (DEQ), and administered as part of the Virginia Pollutant Discharge Elimination System (VPDES) permit program. Mineral mine operators that are considering this program have available to them the option of applying for the General VPDES Permit for Nonmetallic Mineral Mining. Additional information concerning this program is available by contacting DEQ or visiting their web site at <http://www.deq.virginia.gov/permits/water.html>.

## **Expected Changes in Ground Water Quality**

The composition and concentration of substances dissolved in ground water depends upon biological and chemical reactions occurring at the land surface and in the soil zone, and the mineral composition of the aquifers and confining beds through which the water moves.

**Figure 10-9: Cone of depression associated with pumping from a pit sump or well and potential effects on natural discharge. Source: modified from Heath (1998).**

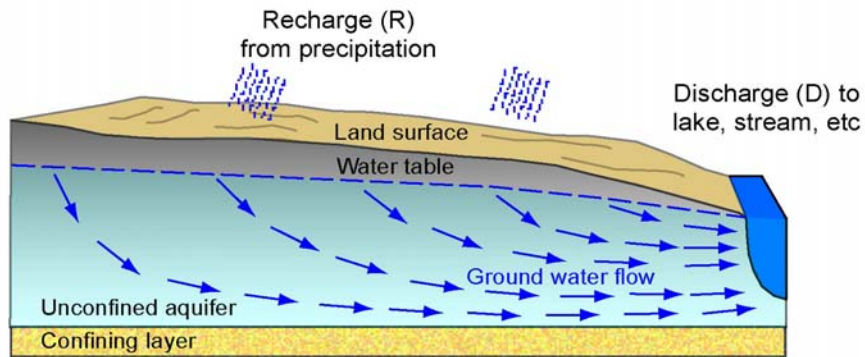

(a) No Pumping: Discharge (D) = Recharge (R)

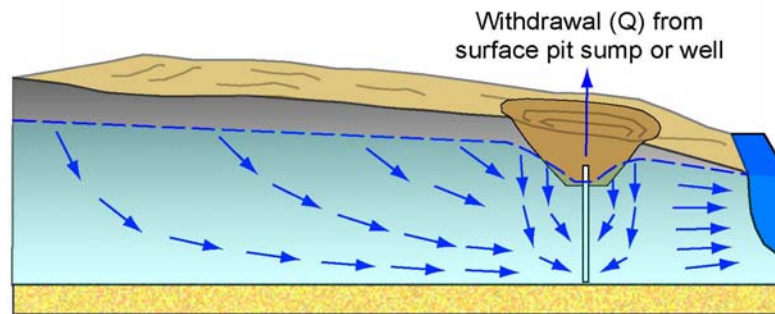

(b) Pumping: Withdrawal (Q) = Reduction in Storage (dS)

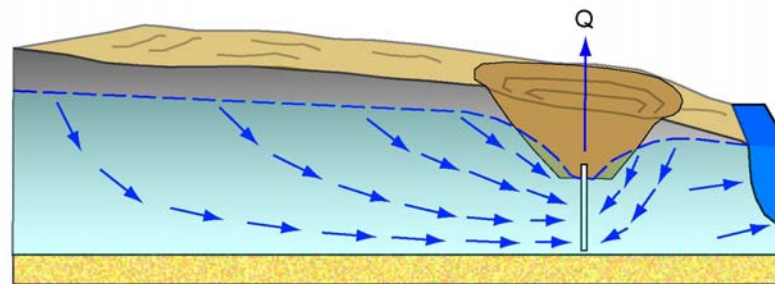

(c) Pumping: Withdrawal (Q) = Reduction in Storage (dS) + Reduction in Discharge (dD)

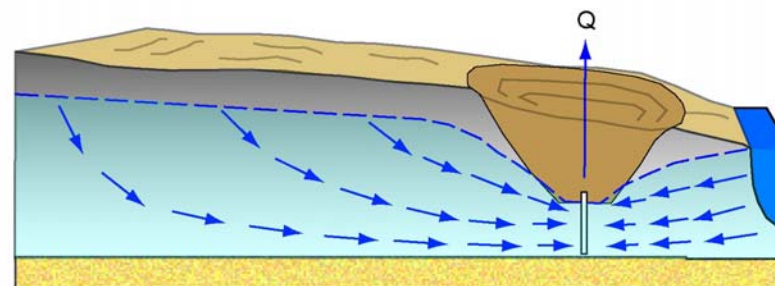

(d) Pumping: Withdrawal (Q) = Reduction in Discharge (dD) + Increase in Recharge (dR)

Prior to mining, the relationships governing the movement of water through the permit area and those affecting the chemical composition of the water are likely to be in a state of relative equilibrium, reflected in the existing baseline water quantity and quality regimes.

With the onset of mining, the surface and ground water hydrology of the area will be altered, disrupting the existing equilibrium. Ground water quality impacts resulting from mining activities may involve changes in the concentration of existing constituents dissolved in the water and/or the addition of new chemical constituents mobilized by oxidation/reduction reactions. Increased mineral concentrations may result from (1) increases in surface area of exposed material; (2) increased oxidation/reduction reactions in the disturbed materials; (3) increase in rate of recharge and movement of water through overburden, mine waste, and mine product stockpiles; and (4) increase in mineral solubility and mobilization due to pH changes caused by the oxidation of pyrite and other sulfide minerals. Sources of poor quality surface water that may recharge the water table aquifer include acid drainage, water released from mineral processing plants, and fertilizers and other soil additives used during reclamation.

For most small non-metallic mineral mining operations, the potential for impacts to ground water quality is greatest during reclamation, when fertilizers or other soil additives are used to promote re-vegetation. In addition to the DMM revegetation guidelines concerning plant nutrient requirements, the impact assessment should consider such factors as the depth to ground water beneath the reclaimed land surface and the proximity of sensitive ground water discharge areas identified in the baseline assessment such as springs, stream base flow, and wetlands. Monitoring inorganic water chemistry prior to and during mining activities will provide the basis for evaluating possible source areas if future impacts occur.

Mineral mining operations that produce metals either as mine product, byproduct, or waste, should complete a full assessment of the potential impacts of the operation on ground water quality. Contaminant transport computer models are widely available for use in analyzing the movement, mixing, and chemical reactions of contaminated water through an aquifer system. These models are typically coupled to a ground water flow model.

### **Potential for Accidental Release of Pollutants**

For most small mineral mining operations, accidentally released pollutants that have the potential to impact ground water include oils, fuels, and cleaning solvents. The most likely pathway for contamination is by direct contact of the pollutant with ground water or the aquifer stratum that is exposed in the mine excavation. Since these pollutants do not naturally occur in ground water, the hydrologic assessment of baseline water quality parameters will not likely include their determinations, unless a pre-existing condition was suspected. The assessment of potential impacts should include an evaluation of safeguard measures to ensure that these pollutants are stored, distributed, transferred, and disposed of in a manner that will minimize the potential for impacting ground water quality.

## **10.6 GROUND WATER PROTECTION PLAN**

The successful design of a ground water protection plan that meets the requirement of regulation 4 VAC 25-31-130(6) will depend upon the quality of the hydrologic baseline and impact assessment, and how this information is integrated with other key operating parameters into the overall mine plan. Since the assessment of potential impacts is largely



predictive in nature, the operating and reclamation plans should be flexible to change if unexpected conditions are encountered. Incorporating ground water monitoring into the overall mining plan is an effective means of identifying early indications of both predicted and unanticipated impacts. Monitoring may be accomplished by conducting scheduled sampling at existing ground water sources, from strategically located monitoring wells (i.e. up-gradient and down-gradient), or a combination of both.

It is appropriate to re-iterate that the regulation requires a plan that *minimizes* adverse effects on water quality and quantity. Meeting this requirement demands that a sufficient amount of information be collected as part of the baseline and impact assessment for evaluating a range of alternatives from which to select the most effective method for impact prevention and/or mitigation. Preventative measures may involve re-designing the overall mining plan in such a way as to avoid the impact altogether. Where an adverse impact is unavoidable, procedures should be incorporated to mitigate to the extent technically feasible, or if not feasible provide a replacement for the lost resources to those users that depend upon them.



WATER SUPPLY INVENTORY LIST – DETAILS								
Map ID (See Page 1)								
<b>Type Of Supply</b>	Well							
	Spring							
	Cistern							
	Municipal							
	Pond							
	Other (specify type)							
<b>Water Use</b>	Domestic							
	Agriculture							
	Industrial							
	Other (specify)							
<b>Well Data</b>	Year drilled							
	Total depth (ft. bgs <sup>1</sup> )							
	Depth to bedrock (ft. bgs)							
	Casing depth (ft. bmp <sup>2</sup> )							
	Well diameter (in.)							
	Well head elev. (ft. amsl <sup>3</sup> )							
	Static water level (ft. bmp)							
	Static water level (ft. amsl)							
	Measurement date / time							
	Water bearing interval (ft.)							
	Seals, grout interval (ft.)							
	Pump depth (ft. bgs)							
	Well yield (cfs or gpm <sup>4</sup> )							
	Well screen (Yes or No)							
Driller's Log Available?								
<b>Spring Data</b>	Spring elev. (ft. amsl)							
	Flow rate (cfs or gpm)							
	Measurement date / time							
	Spring protected? (Yes or No)							
	Type of protection							

- 1 ft bgs = depth in feet below ground surface.
- 2 ft bmp = depth in feet below top of well head.
- 3 ft amsl = elevation in feet above mean sea level.
- 4 cfs = cubic feet per second; gpm = gallons per minute.



## **APPENDIX A: CONTACTS (GENERAL AND EMERGENCY)**

This page intentionally left blank.

## GENERAL CONTACTS

<u>Type of Hazard</u>	<u>Contact Agency</u>	<u>Telephone Number</u>
<b>Environmental Emergencies</b>	Virginia Department of Emergency Management (DEM)	804-674-2400 (24 hours) 800-468-8892 (Toll Free)
<b>Air Pollution</b>	Virginia Department of Environmental Quality (DEQ) - Air Division	804-698-4000
<b>Etiological Agents</b>		
<b>Disease Causing</b>	Virginia Department of Health (VDH), Emergency Preparedness & Response Programs	804-864-7026
	VDH Office of Epidemiology	804-864-8141
<b>Radioactive Materials</b>	VDH Radiological Health Section	804-864-8150
<b>Toxic Substances</b>	DEQ, Division of Solid Waste	804-698-4471
	Hazardous Waste Management	804-698-4199
	Virginia Department of Labor & Industry, Occupational Safety & Health	804-371-2327
	Division of Consolidated Laboratories Emergency Response	804-648-4480
<b>Explosives</b>	State Police	
	Administrative Headquarters	804-674-2000 (24 hours)
	Division I     Richmond	800-552-9965
	Division II    Culpeper	800-572-2260
	Division III   Appomattox	800-552-0962
	Division IV    Wytheville	800-542-8716
	Division V     Chesapeake	800-582-8350
	Division VI    Salem	800-542-5959
	Division VII   Alexandria	800-572-4510
	Bureau of Alcohol, Tobacco, Firearms and Explosives	888-283-2662
<b>Pesticides</b>	State Department of Agriculture and Consumer Services, Virginia Pesticide Control Board	804-371-6558 (Day)
	National Chemical Response and Information Center (CHEMTREC)	800-424-9300 (24 hours)
<b>Water Pollution</b>	DEQ Pollution Response Program	800-468-8892(In Virginia) 804-674-2400 (Out of State)
<b>Transportation Spills HAZMAT/Chemical</b>	CHEMTREC	800-424-9300 (24 hours)

## DEPARTMENT OF ENVIRONMENTAL QUALITY

### Regional Offices For Air, Waste, and Water

#### **Southwest Regional Office**

355 Deadmore Street  
P.O. Box 1688  
Abingdon, Virginia 24212  
276-676-4800

#### **Richmond (Main Office)**

629 East Main St  
P.O. Box 10009  
Richmond, Virginia 23240  
804-698-4000  
800-592-5482 (In Virginia)

#### **Valley Regional Office**

4411 Early Road  
P. O. Box 3000  
Harrisonburg, Virginia 22801  
540-574-7800

#### **Tidewater Regional Office**

5636 Southern Blvd.  
Virginia Beach, Virginia 23462  
757-518-2000

#### **Piedmont Regional Office**

4949-A Cox Rd  
Glen Allen, Virginia 23060  
804-527-5020

#### **Northern Regional Office**

13901 Crown Court  
Woodbridge, Virginia 22193  
703-583-3800

#### **Fredericksburg Satellite Office**

806 Westwood Office Park  
Fredericksburg, Virginia 22401  
540-899-4600

#### **South Central Regional Office**

7705 Timberlake Road  
Lynchburg, Virginia 24502  
434-582-5120

#### **West Central Regional Office**

3019 Peters Creek Road  
Roanoke, Virginia 24019  
540-562-6700



## VIRGINIA DEPARTMENT OF EMERGENCY MANAGEMENT

### Hazardous Materials Response Program

#### Hazardous Materials Field Manager

804-897-6500 x6578

#### Area 1—Northern Virginia

703-441-9836

#### Area 5—Roanoke

434-432-8045

#### Area 2—Richmond

804-897-6500 x 6577

#### Area 6—Southwest Virginia

276-328-2329

#### Area 3—Northern Neck

757-886-2801

#### Area 7—Tidewater - Eastern Shore

757-363-3891

#### Area 4—Northern Virginia - West

540-635-4637

#### Area 8—Roanoke Valley

540-561-6684



This page intentionally left blank.

## **APPENDIX B: ENGLISH TO METRIC**

This page intentionally left blank

<b>Metric System Conversion Table*</b>		
<b>To Convert From:</b>	<b>To:</b>	<b>Multiply by:</b>
<b>Weight/Mass</b>		
Ounces (avoirdupois)	Grams	28.350
Ounces (troy)	Grams	31.1035
Pounds	Kilograms	0.4536
Short Tons	Metric tons	0.9072
Grams	Ounces (avoirdupois)	0.03527
Grams	Ounces (troy)	0.03215
Kilograms	Pounds	2.2046
Metric tons	Short tons	1.1023
<b>Length</b>		
Miles	Kilometers	1.6093
Yards	Meters	0.9144
Feet	Meters	0.3048
Feet	Millimeters	3.048
Feet	Centimeters	30.48
Inches	Millimeters	25.4
Inches	Centimeters	2.54
Kilometers	Miles	0.6214
Meters	Yards	1.0936
Meters	Feet	0.03937
Millimeters	Inches	0.3927
Centimeters	Inches	3.937
<b>Area</b>		
Square miles	Square kilometers	2.590
Acres	Square meters	4,046.873
Acres	Hectares	0.4047
Square yards	Square meters	0.8361
Square feet	Square meters	0.0929
Square inches	Square centimeters	6.4516
Square kilometers	Square miles	0.3861
Square meters	Acres	0.000247
Square meters	Square feet	10.764

<b>Metric System Conversion Table*</b>		
<b>To Convert From:</b>	<b>To:</b>	<b>Multiply by:</b>
<b>Area (continued)</b>		
Square meters	Square yards	1.196
Hectares	Acres	2.471
Hectares	Square meters	10,000.00
Square centimeters	Square inches	0.155
Square millimeters	Square inches	0.00155
<b>Volume</b>		
Cubic yards	Cubic meters	0.7646
Cubic feet	Cubic meters	0.02832
Cubic inches	Cubic centimeter	16.3871
Cubic meters	Cubic yards	1.3079
Cubic meters	Cubic feet	35.3145
Cubic centimeters	Cubic inches	0.06102
Gallons (U.S.)	Liters	3.7854
Liters	Gallons (U.S.)	0.2642
Milliliters	Ounces (fluid)	0.03381
Ounces (fluid)	Milliliters	29.5735
<b>Temperature conversions</b>		
<ul style="list-style-type: none"> <li>• From degrees Fahrenheit to degrees Celsius, subtract 32 and multiply by 5/9.</li> <li>• From degrees Celsius to degrees Fahrenheit, multiply by 9/5 and add 32.</li> </ul>		
<p><b>Example:</b>    <i>Change 200 cubic yards to cubic meters:</i>                              200 cubic yards x 0.7646 = 152.92 cubic meters</p>		

\*The above chart was taken from "Minerals Today," December 1992 issue.

**Unit Weight Of Typical Minerals/Rocks**

	Unit Weight In Place Lb./Cu.Ft.	Unit Weight In Place Tons/Cu.Yd.	Unit Weight Loose or Broken Tons/Cu.Yd.
*Aplite	156	2.10	—
*Basalt	171	2.31	—
Bauxite	100-160	1.35-2.16	1.01-1.62
Clay (natural bed)	109	1.47	1.125
Clay (dense or wet)	111	1.5	1.125
Clay (dry)	85	1.15	0.92
Clay (light kaolin)	104	1.4	1.08
Clay (anthracite)	83	1.125	0.825
Clay (bituminous)	70	0.955	0.70
*Diabase	176-184	2.38-2.48	—
Earth (dry loamy)	78	1.05	0.775-0.915
Earth (dry)	104	1.4	1.12
Earth (wet)	125	1.68	1.35-1.4
Earth (moist)	100	1.35	1.04-1.125
Earth (sand & gravel)	115	1.55	1.32
Gneiss	168	2.26	1.29
Granite	167	2.25	1.26-1.5
Granite & porphyry	170	2.29	1.31
Gravel (dry)	120	1.62	1.45
Gravel (wet)	133	1.8	1.6
Greenstone & trap	187	2.52	1.45
Gypsum	163	2.2	1.5
Iron Ore (hematite)	241-322	3.25-4.35	1.95
Iron Ore (taconite)	150-200	2.02-2.7	1.45-1.93
Limestone	163	2.2	1.33
Limestone (blasted)	1.55	2.1	1.2-1.26
Limestone (marble)	170	2.3	1.31-1.38
Sandstone	149	2.01	1.2-1.49
Sand (dry)	120	1.625	1.45
Sand (moist)	126	1.7	1.49
Sand (wet)	133	1.8	1.6
Sand & gravel (dry)	123	1.66	1.46
Sand & gravel (wet)	144	1.95	1.69
*Slate	172	2.32	—

Derived from Table 2, page 9 of "Analyzing Excavation and Materials Handling Equipment," by L. Adler and H. E. Naumann, February 1970, RDB#53, VPI & SU, Blacksburg, Virginia.

\*From J. H. Griffith, Physical Properties of Typical American Rocks, Iowa Eng. Expt. St. Bull. 131, March 1937.

The page intentionally left blank.